

~~20A.119~~

3.6.7

*From the
Library of
Calvin Ellis, M.D.
1884.*

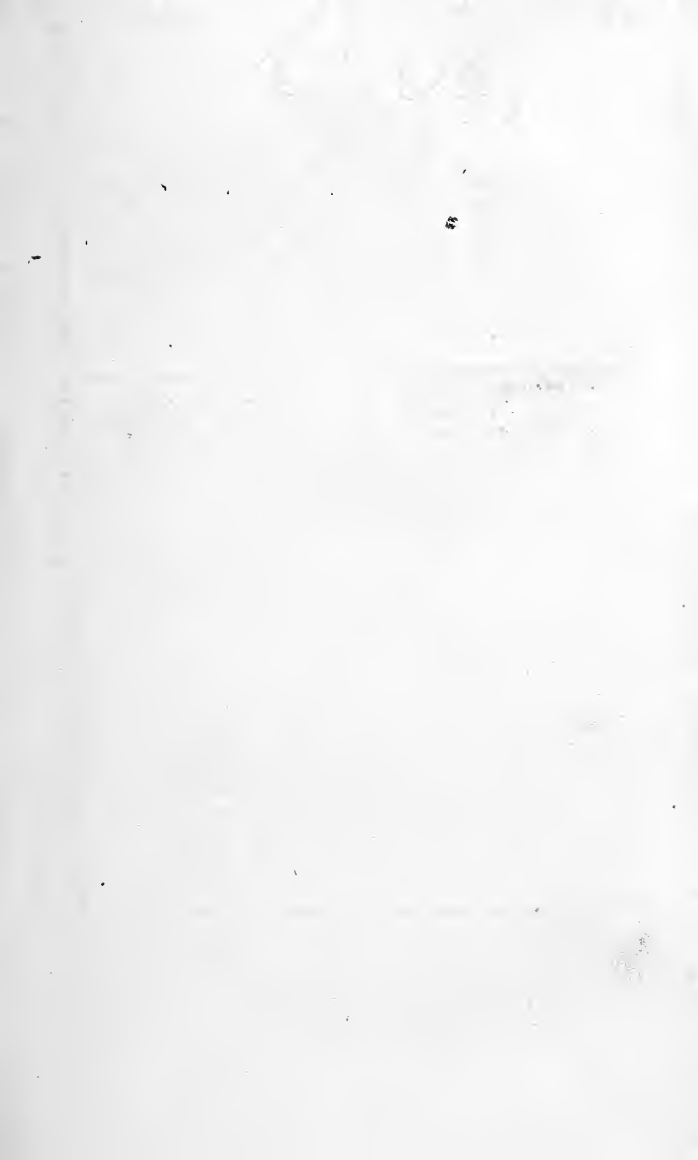

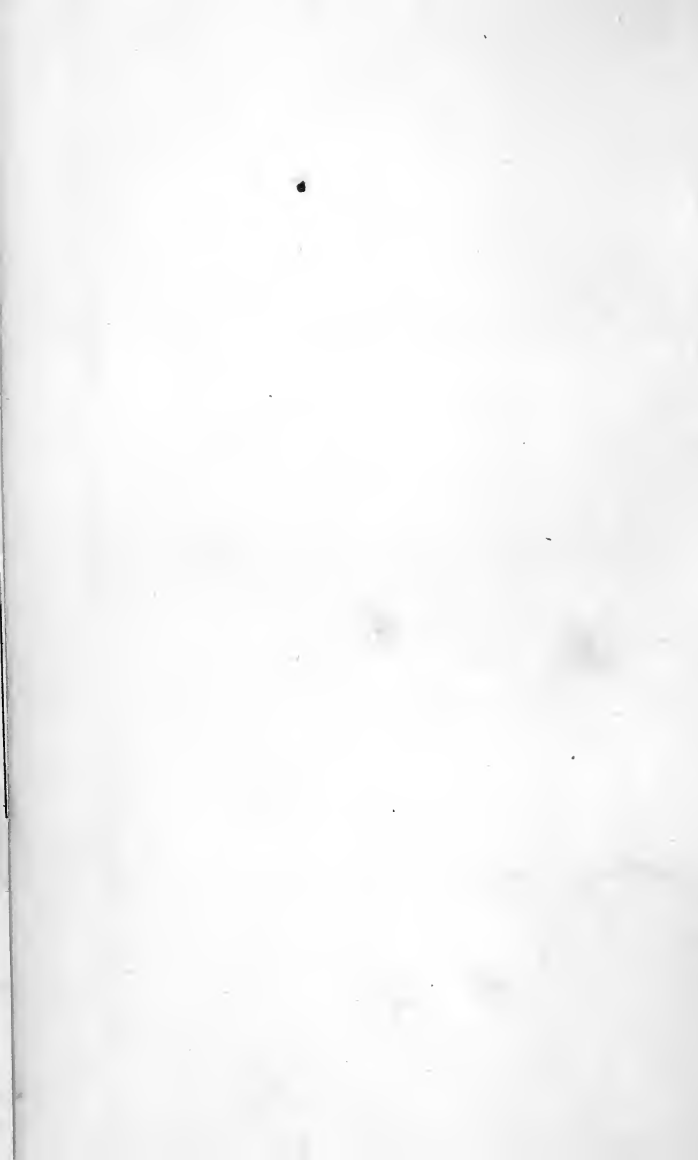

ANATOMICAL MANIPULATION.

LONDON:

J. W. MARTIN, CURSITOR STREET, CHANCERY LANE.

ANATOMICAL
MANIPULATION ;

OR, THE

METHODS OF PURSUING PRACTICAL INVESTIGATIONS

IN

Comparative Anatomy and Physiology.

ALSO AN INTRODUCTION

TO THE USE OF THE MICROSCOPE, ETC.,

AND AN APPENDIX.

BY

ALFRED TULK, M.R.C.S., M.E.S.

AND

ARTHUR HENFREY, A.L.S. M.Mic.S.

WITH ILLUSTRATIVE DIAGRAMS.

LONDON :
JOHN VAN VOORST, PATERNOSTER ROW.

MDCCCXLIV.



Digitized by the Internet Archive
in 2011 with funding from

Open Knowledge Commons and Harvard Medical School

PREFACE.



IN a science like Comparative Anatomy, based as it is upon observation, much of the accuracy with which the eye sees and the mind judges of its facts, must necessarily depend on the means employed in displaying the diversified and often complex structures which compose the bodies of Animals. A knowledge, therefore, of these means, or in other words, of the whole *art of dissection*, is a matter of so much importance that its acquisition has always been held of the highest consequence to the student, for whose guidance Anatomical Instructors have from time to time been published. Almost the only available work of this kind, in our language, is that of Pole, the last edition of which appeared in the year 1813, and is now out of print. The science of Minute Anatomy, however, aided by the recent improvements which have been made in the construction of the microscope as an instrument of research, is the creation of the present day; and the work

referred to, though well adapted to the time at which it appeared, is now in many respects useless to the inquirer in the wide and interesting fields of Comparative and Structural Anatomy.

The want of some guide in these researches having been long felt by the writers of the following pages, and it is presumed by others also engaged in similar pursuits, they were happy to meet with such a one in the excellent "Traité Pratique et Theorique d'Anatomie Comparative" of M. Straus-Durckheim (Paris, 1842), and the idea at the same time suggested itself that they should avail themselves of the extensive zootomical experience of that author to supply the above deficiency in this country. With this view they have followed his plan more or less closely in the First and Third Parts, condensing and translating his matter every where, and making such additions and alterations as they held to be needful, while the whole of the Second Part has been written anew. They would fain hope that they have thus produced a work, which will be found useful in smoothing the way to students entering upon the studies of Comparative Anatomy and Physiology.

PARTS I and II, prepared by ARTHUR HENFREY, treat of Mechanical Arrangements and the Microscope.

PART III, by ALFRED TULK, contains directions for Dissecting and Preserving the several systems of organs.

In addition to the treatise before mentioned, the following works have been consulted :—

Directions for Collecting and Preserving Animals.

Royal College of Surgeons, London.

Knox's Anatomist's Instructor, 1836.

Lauth—Nouveau Manuel d'Anatomiste, Paris, 1829.

Mandl—Traité Pratique du Microscope, Paris, 1839.

Owen's Lectures on the Invertebrated Animals, 1843.

Penny Cyclopædia—Article, Microscope.

Pole's Anatomical Instructor, 1813.

Todd and Bowman's Physiological Anatomy, Part I

In conclusion, the Authors have to express their thanks to Prof. EDWARD FORBES and Dr. GRIFFITH for their articles appended to this work ; as also to Dr. WILLIS, for allowing them to avail themselves of the extracts from Prof. Wagner's Physiology.

THE AUTHORS.

London, Dec. 1843.

CONTENTS.

PART I.—MECHANICAL ARRANGEMENTS.

CHAP. I.—APARTMENTS, &c.

	Page
SECT. 1.—Dissecting Rooms, &c.	3
2.—Workshops, &c.	8

CHAP. II.—INSTRUMENTS.

SECT. 1.—Injecting Instruments	16
2.—Instruments for Dissection — Non-cutting Instruments	34
Cutting Instruments	51

CHAP. III.—SUBSTANCES USED IN PREPARING AND PRESERVING ANIMAL STRUCTURES.

SECT. 1.—Injections	57
Colouring Matters	67
2.—Preservative Solutions	72
Miscellaneous Fluids	77

CHAP. IV.—UPON THE PRESERVATION OF ANATOMICAL PREPARATIONS

Preservative Vessels	81
--------------------------------	----

PART II.—THE MICROSCOPE.

	Page
CHAP. I.—PRELIMINARY OBSERVATIONS ON THE OPTICAL PRINCIPLES CONNECTED WITH MICROSCOPES	89
CHAP. II.—MICROSCOPES AND THEIR APPARATUS.	
SECT. 1.—Mechanical Construction	106
Dissecting Microscopes	112
2.—Accessory Instruments	113
CHAP. III.—MANIPULATION.	
SECT. 1.—Use of the Microscope	117
2.—Preparation and Preservation of Objects	124

PART III.—DISSECTION AND PRESERVATION.

CHAP. I.—INTRODUCTORY REMARKS	135
CHAP. II.—TEGUMENTARY SYSTEM.	
SECT. 1.— <i>Vertebrata</i> , Mammalia	142
— Aves	146
— Reptilia	146
— Chelonia	148
— Pisces	148
SECT. 2.— <i>Articulata</i> , Annelida	149
— Myriapoda	149
— Insecta	150
— Crustacea	154
— Arachnida	155
— Cirrhipeda	155

	Page
SECT. 3.— <i>Mollusca</i> , Cephalopoda	155
— Gasteropoda	156
— Acephala	156
SECT. 4.— <i>Radiata</i> , Entozoa	157
— Echinodermata	157
— Acalephæ	159
— Polypi	159
CHAP. III.—CELLULAR AND ADIPOSE SYSTEMS	160
CHAP. IV.—OSSEOUS SYSTEM.	
SECT. 1.— <i>Vertebrata</i> , Mammalia	162
— Aves	183
— Reptilia	184
— Chelonia	186
— Pisces	187
SECT. 2.— <i>Mollusca</i> , Cephalopoda	191
— Pteropoda	193
— Gasteropoda	193
— Acephala	195
— Brachiopoda	195
SECT. 3.— <i>Radiata</i> , Acalephæ	196
— Polypi	196
— Infusoria	196
CHAP. V.—LIGAMENTOUS SYSTEM	197
CHAP. VI.—MUSCULAR SYSTEM.	
SECT. 1.— <i>Vertebrata</i> , Mammalia	202
— Aves	221
— Reptilia	222
— Chelonia	223
— Pisces	225

	Page
SECT. 2.— <i>Articulata</i> , Annelida	226
— Myriapoda	227
— Insecta	228
— Crustacea	233
— Cirrhipeda	234
— Arachnida	234
SECT. 3.— <i>Mollusca</i> , Cephalopoda	236
— Gasteropoda	238
— Acephala	240
SECT. 4.— <i>Radiata</i>	242
CHAP. VII.—NUTRITIVE SYSTEM.	
SECT. 1.— <i>Vertebrata</i> , Mammalia	244
— Aves	250
— Reptilia	250
— Chelonia	252
— Pisces	252
SECT. 2.— <i>Articulata</i> , Annelida	253
— Myriapoda	254
— Insecta	258
— Crustacea	261
— Arachnida	262
SECT. 3.— <i>Mollusca</i> , Cephalopoda	263
— Gasteropoda	264
— Acephala	266
SECT. 4.— <i>Radiata</i> , Entozoa	268
— Echinodermata	268
— Acalephæ	271
— Polypi	271
— Infusoria	272
CHAP. VIII.—SEROUS SYSTEM—MAMMALIA, AVES, REPTILIA, CHELONIA, AND PISCES	
	273

CHAP. IX.—GLANDULAR SYSTEM.

Page

SECT. 1.— <i>Vertebrata</i> , Mammalia	274
— Aves	279
— Reptilia and Chelonia	279
— Pisces	279
SECT. 2.— <i>Articulata</i> , Myriapoda	280
— Insecta	281
— Arachnida	283
SECT. 3.— <i>Mollusca</i> , Cephalopoda	283
— Gasteropoda	283
— Acephala	284

CHAP. X.—GENERATIVE SYSTEM.

SECT. 1.— <i>Vertebrata</i> , Mammalia	285
— Aves	289
— Reptilia	290
— Chelonia	290
— Pisces	291
SECT. 2.— <i>Articulata</i> , Annelida	291
— Myriapoda	291
— Insecta	291
— Crustacea	292
— Arachnida	293
SECT. 3.— <i>Mollusca</i> , Cephalopoda	293
— Gasteropoda	294
— Acephala	294
SECT. 4.— <i>Radiata</i> , Entozoa	295
— Echinodermata	295
— Acalephæ	295
— Polypi	296

	Page
CHAP. XI.—RESPIRATORY SYSTEM.	
SECT. 1.— <i>Vertebrata</i> , Mammalia	299
— Aves	302
— Reptilia	304
— Chelonia	304
— Pisces	305
SECT. 2.— <i>Articulata</i> , Annelida	305
— Myriapoda	305
— Insecta	307
— Crustacea	307
— Arachnida	308
SECT. 3.— <i>Mollusca</i> , Cephalopoda	309
— Pteropoda	309
— Gasteropoda	310
— Acephala	311
SECT. 4.— <i>Radiata</i> , Echinodermata	312
CHAP. XII.—CIRCULATORY SYSTEM.	
SECT. 1.— <i>Vertebrata</i> , Mammalia	313
— Aves	337
— Reptilia	342
— Chelonia	343
— Pisces	345
SECT. 2.— <i>Articulata</i> , Annelida	345
— Crustacea	346
— Arachnida	348
— Myriapoda	349
— Insecta	351
SECT. 3.— <i>Mollusca</i> , Cephalopoda	351
— Gasteropoda	352
— Acephala	355

	Page
SECT. 4.— <i>Radiata</i> , Echinodermata	355
— Acalephæ	358

CHAP. XIII.—NERVOUS SYSTEM.

SECT. 1.— <i>Vertebrata</i> , Mammalia	359
— Aves	370
— Reptilia	370
— Chelonia	370
— Pisces	371
SECT. 2.— <i>Articulata</i> , Annelida	371
— Myriapoda	373
— Insecta	374
— Crustacea	378
— Arachnida	379
SECT. 3.— <i>Mollusca</i> , Cephalopoda	380
— Gasteropoda	381
— Acephala	381
SECT. 4.— <i>Radiata</i> , Entozoa	382
— Echinodermata	383
— Polypi	384

CHAP. XIV.—ORGANS OF THE SENSES.

SECT. 1.— <i>Vertebrata</i> , Mammalia	384
— Aves	395
— Reptilia	397
— Chelonia	398
— Pisces	398
SECT. 2.— <i>Articulata</i> , Annelida	398
— Myriapoda	399
— Insecta	399

	Page
SECT. 2.— <i>Articulata</i> , Crustacea	401
— Arachnida	401
SECT. 3.— <i>Mollusca</i> , Cephalopoda	402
— Gasteropoda	403
Conclusion	403
Appendix	405

Part I.

MECHANICAL ARRANGEMENTS.

CHAPTER I.

APARTMENTS, &c.

SECT. I.—DISSECTING ROOMS, &c.

1. ANIMALS may be divided in relation to the methods employed for their dissection, according to their size, into four classes, namely, very large animals, such as the *horse*, the *ox*, and creatures above that size; those of ordinary dimensions, as *man*, the *small Ruminants*, &c.; moderately small species, as the *cat*, *rabbit*, and *most birds*; and, lastly, those minute objects which require the aid of magnifying instruments in their investigation. The first two of these classes, from their great bulk, the mass of offal, and the putrid vapours to which they give rise, will obviously need a separate apartment distinct from the private study of the anatomist; while it is in the latter, that the third, and more especially the last class of objects, in dissecting which the microscope and other delicate contrivances must be used, may be most conveniently examined.

2. The rooms or halls appropriated to the dissection of very large animals, as is the case in veterinary schools, should be situated upon the ground floor, and should open externally by a gate, so that any huge carcase,

even that of an elephant, may be brought in upon a waggon. They should be so exposed as to be free from damp; paved, and well drained, perfectly lighted by a number of windows, either from above or on both sides, and rather lofty, to allow the gaseous vapours to ascend above the heads of those dissecting, and escape by means of tourniquet ventilators, placed near the top of each window.

The extent of the hall, taking a certain number of animals to be dissected at once, may be thus calculated: the body of a large ruminant occupies with its platform a square space of nearly 9 feet, and the table for preparing its voluminous organs upon, about $7\frac{1}{2}$ feet; so if three platforms be arranged in a row down one side, and four tables along the other, the length of the room would be 30 feet, and the width 18 feet. During winter, two or more stoves, provided with coppers for heating water or injections, may be placed in the middle of the apartment, so as to distribute the warmth equally throughout.

The moveable articles, which a large hall like the above should contain, are some cupboards with shelves, at each end, some platforms, tables, and wooden chairs; with sundry others, such as diagram boards, drawing frames, and disinfecting apparatus.

3. Large animals are usually dissected in the veterinary schools upon the ground, or on the vehicles in which they have been brought; but the greatest inconvenience is thereby felt, from the inability to turn different parts to the light. This, however, may be remedied by the use of platforms, of sufficient size to support a

horse, or ox; the opportunities of dissecting larger subjects, such as elephants and rhinoceroses, being too rare to call for any special contrivance of the kind. These platforms (fig. 1) should consist of a horizontal piece of timber 8 feet 4 inches long, by 3 feet wide, and 16 inches

from the surface of the ground, covered with a layer of small planks, and slightly inclined towards one end, with a gutter in the middle to facilitate the escape of fluid, by a hole at A, to which a tube is attached. The wood work or base of the platform has the form of an X, the main beam (B C), from 7 to 8 inches wide being placed diagonally across, while two others of equal strength (D E, F G), are similarly disposed, but do not join in the centre, to avoid

Fig. 1.

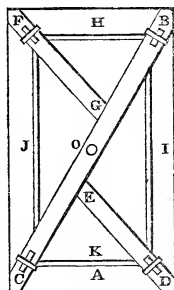

weakening the principal stay, upon which the platform is to revolve by a pivot fixed into the floor, and penetrating the plank B C at O. More slender stays (H I J K), unite these diagonal branches, and beneath the extremities of the latter are perpendicular iron castors, about 7 inches in diameter, to assist the rotatory motion of the platform. Two of these are rather shorter than the others, to give the platform a gentle slope towards the drainage opening (A). If the subject be too large for the platform, its surface can be increased by placing the head, with part of the neck, upon a plank thrust under the body.

4. The dissecting tables should form a row opposite

the platforms, at a yard distance from the wall, and with a space of $2\frac{1}{2}$ yards between their centres. They should be somewhat less than those ordinarily used in dissecting rooms; about 1 yard long by $\frac{3}{4}$ wide, as bodies only of middling size, as those of a sheep or goat, or fragments of large animals, are dissected upon them. Above each platform and table a rope with pulleys should be attached to the ceiling.

5. The same general principles of construction will apply to ordinary dissecting rooms, as to the large halls. The best kind of dissecting table is made in the form of a slightly concave platform covered with lead or zinc, turning upon its centre, which should rest upon a round table, with its four legs fastened to the floor. The apartment is to be heated, like the preceding, by means of stoves, in number proportionate to its extent.

6. The study of the anatomist, is the place in which the latter engages in the dissection of animals of moderately small size, and those below it; it serves also for other kinds of work, such as microscopic observations, drawing, and the preparation of books for the press. This apartment should differ therefore considerably from the dissecting rooms spoken of above. It ought to have a south aspect, that the objects under dissection may be directly illuminated by the sun; the window should be without embrasure, so that the table may be placed quite against the glass. Each side of the window should be furnished within with a white and thick calico blind, to prevent the passage of a glaring light, where objectionable. These blinds will cover with their shadow the whole dissecting table, with the exception

of the spot where the specimen is, upon which researches are being made; and as the stream of light which passes beneath them is, usually, still too large, it may be diminished by means of screens, placed either upon the table, or against the window, and which are adjusted one behind the other according as is necessary, so as to allow only of a sufficient ray of light impinging upon the object, whilst all the rest of the table is in shadow; this admits of the drawing or writing paper being so placed, that the light which falls upon it does not affect the eyes. Coloured, and especially green, blinds might have the advantage of relieving the sight, by shedding a softened tint upon all the objects placed upon the table; and this would be very important to the observer, who often fatigues his eyes considerably in the examination of minute animals, or in making microscopic observations; but these tints, communicating also to the paper on which he draws a particular colour, injure the effect of the designs, to a great degree, when viewed afterwards by a white light.

7. Above the middle of the dissecting table there should be fixed to the ceiling an iron hook, to which different objects, and especially the injectory, which will be described further on, may be suspended. The study of the anatomist, serving at once as a laboratory and an ordinary dwelling, contains a greater number of moveables than the dissecting rooms, as well as part of his library, and many other objects subservient to his researches, such as a lamp, drawing table, &c.

8. As it is generally admitted for the facility of work, that objects to be drawn, or the microscope,

should be lighted from the left, the dissecting table should be so placed against the window as to receive the light from that side. A convenient size for this table will be, for example, 3 feet long by 2 feet wide. As to height, it must vary according to that of the person who makes use of it, and should be such, that when seated, the microscope can be easily looked through, with the hands resting comfortably upon the stage, in the ordinary position of dissection, a condition quite essential in prosecuting anatomical researches with this instrument.



SECT. II.—WORKSHOPS, &c.

9. MACERATING ROOM.—In every large establishment, where many skeletons are prepared, it is necessary to have a separate place for macerating bones. This may be some cellar, chamber, or a simple shed; but care must be taken that it is not so exposed to the sun, that the latter strikes upon the macerating troughs; a dark situation, therefore, is the best, but not a cool one, lest putrefaction be retarded. These conditions, so essential to a macerating locality, are required to prevent green matter or mould from developing itself in the troughs, more especially the former, which attaches itself to the bones at the bottom of the water, incrusts them, and imparts a black or yellow tint, which can never be got rid of. This happens when the trough is exposed to the open air, and chiefly to the sun: even

when there is no production of green matter, the flesh itself turns brown and tinges the bones.

The moveables in the places of maceration are simply some troughs, in which bones are macerated, and pails for conveying water.

10. TROUGHES.—These are cylindrical vessels of all dimensions, the large size in wood, the middling in earthenware, and the smallest in glass. The wooden ones should be of deal, ash, or any other timber which does not lose colour; not of oak or walnut, as they impart a black colour to the water, especially if it contains a little iron. In this case the gallic acid of these woods forms with the iron a perfect ink, which penetrates the bones, and so colours them that they cannot be whitened; and even if no iron is present in the water, the tanning renders the latter perfectly black, and colours the bones grey. The best troughs are those of earthenware, but they can only serve for small animals. They can be kept much cleaner, and freed better from green matter and mouldiness than the wooden ones, in which, when these matters are once developed, there is the greatest difficulty in destroying the germs which incrust the timber. It may however be effected by reversing the trough over a fire with live coal, and heating it nearly to ignition; boiling water does not destroy them.

The earthenware pans may be also well heated by fire to destroy these germs; and the glass ones, generally the smallest, can be rinsed out with a concentrated acid, after being well washed, so as to leave nothing but the germs for the acid to act upon.

The troughs should be, if possible, sheltered from a current of air, which causes the evaporation of the water, in which case this latter must be renewed at intervals. To prevent this inconvenience, the troughs should be well covered up, and during the time of maceration be meddled with no more than is necessary, for fear of diffusing the fetid odour.

11. DRYING PLACE.—There should be near to the macerating room one exposed to the sun for drying and bleaching the bones. A part of this place, which is best located in a garden, should be open, so that the bones may be exposed as long as possible to the sun, dew, rain, and snow, the alternate vicissitudes of which produce the required bleaching.

Another part of the drying place should be a chamber provided with a stove, in which every kind of preparation may be quickly dried. The methods employed will be described in the chapter upon the osseous system.

12. In the external part of the drying place should be placed several tables with raised borders, so that the objects placed upon them may not fall off, and having at their lowest extremity a small hole by which the water may drain off. The upper part of these tables may be of solid wood, laths, or metal.

In this room there should be, besides the stove, some tables and places for hanging up preparations, and several basket-work frames which may be suspended from the ceiling, or laid upon sticks, and serve to dry different specimens upon.

13. BOXES FOR INSECT-MADE SKELETONS.—These

boxes are little laboratories, in which the agency of different insects, but chiefly ants, is employed for making the skeletons of very small vertebrated animals. Their size should be two inches each way, seldom more, and they should be made of some wood which does not suffer from moisture, and should shut as close as possible. They may be also of tin or zinc, but their outer and inner surface should be unpolished and even rough, so that the insects may travel over them, in going out, and coming in. In their sides there should be a great number of holes just large enough to let a single ant pass through, but not to admit of its conveying away with it any small ossicles, which they never fail to do if not prevented. If these boxes are destined for the operations of *dermestes*, *ptinus fur*, or *anthrenus*, they may be of any substance, as card, since these insects gnawing only the dry organic substances preserved in the interior of houses, there is no need of their being exposed to the wet, while those in which the ants work enclose fresh animals, and should be placed near the nests. The *dermestes* and *ptinus* seldom quit the boxes.

14. WORKSHOP.—An establishment devoted to the study of anatomy, and amongst others, to the art of making skeletons, must necessarily have a workshop, provided with a sufficient number of tools; since it is there that the pieces of metal, wood, leather, &c., required in mounting skeletons, are finally adjusted, where injections are prepared, and the vessels for preserving anatomical preparations sealed up.

This work-shop should contain a small lathe-drill for piercing the bones. There should also be a fire-place

for operations requiring its use, and lastly a cistern for the supply of water; while here also the stores, jars, preserving fluids, injecting matters, &c., are kept.

15. **TOOLS.**—In addition to the instruments already noted, there should be a large table, a small bench, with a vice and anvil, a grind-stone for whetting large instruments, tools belonging to the lathe, a small drill-bow with drills of different sizes, files, rasps, gravers, chisels, different flat and cutting pincers, pliers, hammers, a mallet, punches of different sizes for labels, saws, &c. Besides these ordinary implements, it is convenient to have some others, which if not indispensable, are at least, very useful; they are as follows:—

16. **MACHINE FOR CUTTING THE GLASS PLATES USED AS COVERS TO THE GLASS JARS.**—The jars in which anatomical preparations are preserved, are occasionally closed by plates of glass hermetically luted to them. These plates, generally round, are difficult to cut with the hand, except a wooden pattern of each size is provided, which would be almost endless work, and would cost more than a windle which can be used for cutting the plates. This machine consists of a board 1 foot 8 inches long,

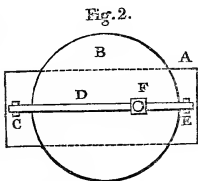

by 8 inches or a little more in width (fig. 2. A). On the middle of this, which serves for its support, is a round disc of wood (B) about 1 foot 4 inches in diameter, turning on its centre. Towards one extremity of the board, at a little distance from the edge of the disc, there is fixed an iron hinge (C), in which the extre-

imity of a square iron rod (D) plays, so that it can be raised and lowered in order to be placed parallel to the disc, over the centre of which it passes, and is prolonged beyond it; at the other end it rests in a second hinge, similar to the first (E), but without the pin. This rod thus placed must be parallel to the disc, and about half an inch distant from it; upon it slides a small copper carrier (F), bearing below a diamond for cutting the glass, and above, a pressure screw for fixing it upon the rod. Around the centre of the disc, and upon it, are traced a great number of concentric circles distant from each other one quarter of an inch, to point out the size of the plates to be cut, and at the same time to assist in adjusting the piece of glass employed. To use this windle, the piece of glass is cemented upon the centre of the disc, and the carrier, which supports the diamond, fixed in such a manner that the latter corresponds to the circumference of the circle, the size of which it is wished the plate should be; the rod is lowered upon the plate of glass and kept there by the left hand, so that the diamond rests slightly upon it, then making the disc turn round with the right hand, the glass is borne along with it, and cut by the diamond.

For cutting plates which are not round, as very often happens, the outline of the shape to be given is traced upon a sheet of paper, the piece of glass placed above it, and the plate cut freely with the hand raised, following the figure placed beneath.

17. DRILL STOCKS.—These are of two kinds, one of which can be fixed by screwing into the table, and be

set in motion by a bow. It is with the assistance of this instrument that solid bodies of moderate size are pierced, and the strongest drill which fits in may be about a line in thickness. The second sort used for piercing very fine holes, such as might be made with a needle, is so contrived as to be set in motion by the fingers, between which the handle of the instrument rolls.

The fine drills have the form of those used for piercing metals, or are simply round or square pointed, when they are to serve for piercing very fine bones.

18. LAMP FRAME.—As it is often necessary to keep liquids at an elevated temperature, it is very useful to have a small spirit lamp frame, upon which a vessel containing the substance to be heated may be placed. This apparatus may be of any shape, but the most convenient is that in which the frame, on which the vessel is placed, is formed by a circle, 4 inches or more in diameter; from this proceed three tongues directed towards the centre, leaving a space of about $\frac{3}{4}$ of an inch, so as not to intercept the flame. The lamp placed beneath the middle of the frame should be so constructed, that by means of a screw, the wick may be raised or lowered to regulate the heat as required.

19. NEOSGEN.—An apparatus for artificial incubation. Anatomists in pursuing investigations, involving the stages of development of the fœtus of birds, make use of this instrument, but every one having peculiar notions as to its modifications, it will suffice to give the general principles here. The principal conditions which appear to be required, are an equable heat, some degree

of moisture, and free access of air. The apparatus generally consists of a cylindrical vessel of tin having double sides, the intervening space being filled with some non-conducting substance ; the bottom is perforated by tubes allowing the air to enter ; the eggs are kept on trays supported by little columns, so as to allow of their being placed one above another. The whole has a wooden cover (pierced with holes), and is heated by a spirit lamp placed beneath a wide tube, closed above, which passes up the middle of the apparatus. It must be kept where it is not exposed to a current of air, and the eggs should be marked with ink as they are put into the apparatus, and turned every two or three days.

It is obvious that the foregoing extensive array of appliances is only given to show what should be done when circumstances allow of it, and in a large establishment ; but it is hoped, that the student will be able to select those portions best adapted to his means and the particular direction of his investigations.

It is with this idea that so general and comprehensive a view of the subject has been taken.

CHAPTER II.

INSTRUMENTS.

20. IN addition to instruments for actual dissection, anatomists make use of certain others which prepare the objects of dissection, in such a manner that the former act to the greatest possible advantage. The most important among these, are those for injecting the different vascular structures, so as to display them with greater distinctness.

SECT. I.—INJECTING INSTRUMENTS.

21. SWAMMERDAM'S SYRINGE.—The instrument usually employed for injections is the syringe contrived by Swammerdam. It is of the ordinary shape—a cylindrical body, with a piston working in it to drive the injection into the vessels; but as it would be difficult to fasten the tube to the vessel, if the former were fixed to the body of the instrument, this is provided with a second tube fitting over the other, to which it is adjusted when necessary, by a bayonet catch or other simple contrivance, a screw being objectionable for obvious reasons. This second tube is to be fixed by a ligature into the vessel to be injected, and as these vary, the instrument is

generally provided with several of them, with different sized nozzles. The inner tube (which forms part of the syringe itself) should be provided with a cock to prevent the escape of the liquid. The piston rod commonly has a large button at its upper extremity, which the operator places against his breast, in order to push with greater force and regularity. The ordinary syringes used at the medical schools hold about two quarts, which is sufficient to inject the principal trunks.

22. When these syringes are of small size, they ought to be bored very truly, in order that the piston may slide with equal freedom in all parts, so as to allow the operator to feel the slightest resistance to the passage of the fluid, and thus to warn him to moderate his efforts when there is danger of rupturing any vessel; and, on the other hand, that it may not be loose in places and produce jerks. The piston ought also to be so perfectly adapted, that the liquid injection cannot get behind it, and its thickness should at least equal its diameter. The mass of this thickness is ordinarily made up of discs of felt, which may be more or less compressed by means of the screw which receives the inferior metal plate of the piston.

23. M. Charrière has invented another kind of piston, infinitely better, which slides much more freely, and does not allow the injection to escape. It also consists of two parallel discs (fig. 3, A, B), placed at some distance apart, and rather less than the internal diameter of the syringe; instead of the discs of felt, there are two of soft leather (C, D), placed in the middle, in

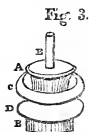

contact, their diameter being half as much again as the bore of the syringe. The intervals between these discs and the metal ones are bound with packthread, only leaving space enough between them and the walls of the pump to lodge the leather discs, which are turned back in the form of a hood over the packthread on each side, thus applying themselves to the inside of the syringe. When the piston is pushed down, the liquid endeavours to make its way towards the upper chamber of the syringe, and entering the bell-shaped cavity formed by the leather disc, it presses the edges of the leather against the walls of the pump, and thus prevents its own escape. In drawing up the piston a similar action takes place, the air being substituted for the liquid. In both movements the piston slides with the greatest facility.

24. Every time an instrument is used it should be taken to pieces, and all parts thoroughly cleaned; and should be placed separately, if possible, in the box where they are kept, to prevent any parts becoming fixed together by oxydation. To clean greasy portions, spirit of turpentine is used; for others, hot water or alcohol, according to what has been used as the vehicle of the injection.

25. In small syringes the piston-rod should end in a ring, and the cap of the syringe (through which it passes) should be provided with a ring at each side. Placing the first two fingers in the latter, and the thumb in the ring of the piston rod, a very regular and safe motion can be communicated to it. It has been said, that the body of the pump should be fixed to the canula

by a bayonet catch, but it may simply slide into it. To prevent their separation in large instruments, the canula should be furnished with two ears, with holes in them, to attach a loop of string, which passes round the fingers of the hand that supports the pump.

26. As the same *quantity* of matter may have to be injected through different *sized* vessels, the instrument should be provided with several canulas of different calibre. One to inject the aorta of man should be about half an inch, external diameter, the others may gradually diminish in size, until the smallest is about one-eighth.

The large canulas should have a cock, in order to retain the injection until it sets; at their upper part should be two circular grooves to lodge the ligature of the vessel. The smaller sizes need only be furnished with a cork, and one groove will be sufficient.

By placing a flexible tube (about 20 inches long for a syringe holding a quart) between the pump and the canula, the instrument may be supported on the table or basin where the subject is placed, by which means much fatigue is avoided, and a more regular motion obtained.

27. INJECTING PUMP.—The apparatus about to be described, may be very advantageously substituted for that of Swammerdam; it not only allows the slightest resistance to be appreciated, but the injection may be continued to any extent without interruption in charging the receiver.

This pump is formed of a cylindrical brass basin (fig. 4, A A), in the centre of the bottom of which is screwed,

vertically a force pump (B). At one side of the latter,

Fig. 4.

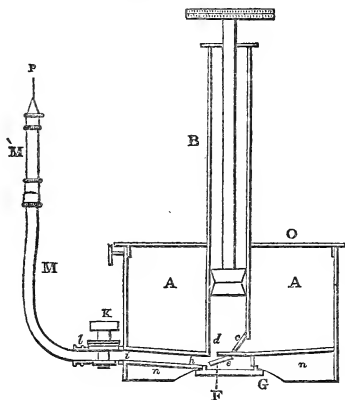

level with the bottom of the basin, is an orifice furnished with a valve (c) internally, allowing the liquid to enter and rise, when drawn up by the piston, but preventing its exit. At the bottom of the body of the pump, towards the side, is the opening of escape (d) leading into a little chamber (e), situated in the base, and of rather

less diameter than the pump. The last mentioned orifice has a valve (F) in the chamber, allowing the escape of the liquid from the pump, but preventing its return. This valve is supported by a tongue-shaped piece, fixed to the side opposite the orifice of communication and serving to raise the valve so as to press it against the opening. The bottom of the little chamber, formed of a screwed plate (G), may be removed to clean the internal parts. At the side of the chamber, near the escape valve, is the orifice of a horizontal canal (h), which opens outside the basin near the bottom (i); on this last orifice is screwed a cock (K), and on this the collar (l) of a flexible tube (M) of the same size as the canal. At the other end of this tube is fixed a canula (P), like

those used for Swammerdam's instrument. The under part of the bottom of the basin is filled in with lead (*n*), which thus surrounds the central chamber and the horizontal canal. The basin is closed above by a flat plate of brass (*O*), with an internal shoulder; the pump passes through the middle, and is kept steady by it. It is as well to have the flexible tube (*M*) in two pieces; these are joined either by a screw, or simply by sliding into one another, which is generally sufficient. The flexible tubes should be very pliant. For alcohol or aqueous injections, nothing is better than a caoutchouc tube, which must not be confounded with those made of *artificial gum elastic* (like common sounds), which are made of linseed oil prepared and dried, this substance being soluble in alcohol. For greasy substances these latter tubes are best, as caoutchouc is dissolved by them, especially when warm.

By means of this apparatus an injection can be made without fear of deranging anything in the body of the subject. The apparatus is placed on the table (its weight serving to fix it), and the canula tied into the vessel as usual. The injecting matter is poured into the basin, and by working the pump is driven into the vessels. The small diameter of the pump allows it not only to be moved with much less force than a large syringe, but causes the slightest obstruction to be felt with distinctness.

28. An apparatus of this kind, the basin holding about a pint, and the pump measuring 7 inches high by $\frac{3}{4}$ ths of an inch internal diameter, is sufficient to inject the body of a child of 10 years old, by the crurals or

carotids. This instrument being suited to the injection of animals of very different sizes, should be provided with canulas (fig. 5) varying from the size of the horizontal canal down to $\frac{1}{25}$ th of an inch; also, as it is sometimes difficult to attach these to a vessel (especially when adherent), some elbowed canulas should be provided; the bent part need not be longer than two or three times the thickness of the tube, as that will suffice to attach the ligatures.

Fig. 5.

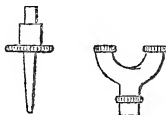

When two vessels are to be injected at once, (such as the two crural) a bifurcated mounting (fig. 5) should be placed on the elastic tube and two others attached to it.

29. CAOUTCHOUC BOTTLE FOR INJECTING.—As the above described instruments are too coarse and unwieldy for some minute injections, such as in the Mollusca, &c., M. Straus-Durckheim has used a very simple instrument which answers every purpose. This is a caoutchouc bottle of the form of fig. 6, rather more than 1 inch in diameter, with a metal collar about 2 inches long.

Fig. 6.



The caoutchouc should be about $\frac{1}{2}$ th of an inch thick, and the extremity of the neck or collar form a ring, into which slips the rest of the apparatus. This consists of a capillary steel tube mounted in wood, ivory, or iron, so that it may be used for mercurial injections. (It will be found very convenient if these jets are made to fit all the different fine injecting instruments).

This instrument is used in the following manner :— It must first be filled with the liquid, which is done by strongly compressing the caoutchouc, then placing the tube in the liquid and allowing the bottle to regain its shape, when of course the liquid rushes up into it to fill the vacuum. Holding it then between the thumb and index finger of the right hand, it must be introduced into the vessel, and the injection pressed out with a force apportioned to the nature of the subject. The injection being completely under control the smallest parts may be filled separately, if desirable. As the air rushes in when the pressure is removed, the lower part of the bottle should be kept uppermost, so that it may gain the surface of the liquid.

It being difficult to inject even very small vessels without tying in the jet to prevent the escape of the liquid, and as an assistant is not always at hand to apply the ligature, while the apparatus is held in its place, the following method will enable any one to do it for themselves. After having opened the vessel, a knot must be tied round it with long ends, one of which is to be twisted round the index finger of the left hand, and the other round the middle finger, after having passed it round a nail fixed to the table; then placing the jet in the vessel with the right hand, the ends of the thread are to be pulled, which tightens the knot, and fixes the apparatus.

30. Although this injecting bag is the simplest and cheapest instrument that can be employed for fine operations, it presents several inconveniences. In the first place, it is but seldom that caoutchouc bottles can be

procured small enough, and even then they are generally too thin and weak. Again, from its form it is very difficult to clean, whilst it is indispensable that it should always be kept so, as the residue of an old *mass*, in drying, would form coarse particles which could scarcely fail to choke the fine tubes. Lastly, the greatest defect is, that the caoutchouc is attacked and destroyed by greasy matters, especially by essential oils, which are occasionally used. This led M. Straus-Durckheim to contrive a little apparatus, which he calls a *Clysette*, which has all the advantages of the bottle without its defects.

31. CLYSETTE, (fig. 7).—This instrument is formed on the plan of a pair of bellows, and is composed of two circular metal flaps, (A).

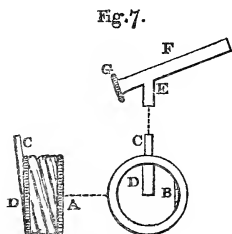

The figure only shows the fixed flap, about $1\frac{1}{2}$ inch in diameter, seen from within, and united to its fellow by an internal hinge (B). The fixed flap is prolonged into a little tube (C) (at the distance of one quarter of the circle from the hinge) about $\frac{1}{4}$ of an inch long, with a calibre of $\frac{1}{8}$ th of an inch, opening into the cavity

of the flap, along its internal face (D). This tube must not open on the margin of the flap, which must remain free in the whole of its circumference, in order to give attachment to the leather uniting the two. On the tube already described, fits another (simply slipping on to it) rather longer (E). This second tube, joins obliquely the extremity of a third (F), 2 inches long and

$\frac{1}{8}$ th of an inch internal diameter, these two are in one piece. The last tube is closed posteriorly by a good screw, and terminates at the other end in a collar, into which fits the apparatus of the jet or fine canula.

The margins of the metal sides about $\frac{1}{8}$ th of an inch thick, have a deep groove running round them, into which the leather is fastened, by binding with pack-thread. The leather covers the hinge, and on the side next it, is only just wide enough to allow the movement of the flaps; on the opposite side it is sufficiently wide to allow them to make an angle of 55 degrees. The leather must be thin, of a close texture, and impermeable to the substance of the injection, without losing any of its suppleness.

In order that all parts may be easily cleaned, the moveable flap consists of a simple ring, closed by a cover screwing into it; thus almost the whole cavity can be exposed without derangement of the parts: the tube carrying the jets is cleaned also by removing its posterior screw, (G).

To use the *clysette*, it should be placed, when filled, in the palm of the hand, in such a manner that the tube can be conveniently held between the thumb and fore-finger, while the other three fingers press upon the moveable flap.

32. INJECTING PIPE OR PIPETTE.—The two instruments just described are still too large for some very fine injections, such as most of the Gasteropoda and Acephala. Another apparatus, still simpler (fig. 8) and more easily used, is a tube or pipette with flexible stems so constructed as to fit them for receiving

jets of various sizes, and to admit of their being easily cleaned.

Fig. 8.

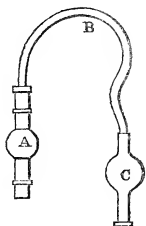

It is composed of a principal piece (A), of glass in the form of a hollow sphere, about $\frac{1}{2}$ an inch internal diameter, with two necks opposite to one another, each about $\frac{1}{5}$ th of an inch long, and $\frac{1}{12}$ th of an inch in diameter. These two necks are furnished with metal collars, one about $\frac{2}{5}$ ths of an inch wide, to receive the metal mounting of the end of a flexible tube (B); the other collar, $\frac{1}{4}$ th of an inch wide, receives the mounting of the jet, which had better be of metal, and is either of the same shape as the other, or simply a truncated cone with a milled rim, so as to be easily held. The second piece is a very flexible elastic tube (B), about 8 inches long, fixed at one end to the piece just described, and at the other to one of the necks of a glass apparatus (C), very much like the first, but larger, with the second neck longer, and with the edge turned out a little, so as to be easily retained between the lips. By means of this little instrument, the injection may be driven by blowing, into the vessels. The hollow ball of the mouth-piece is to receive the saliva, which would otherwise flow into the injection.

In the absence of this instrument, a pipette, with a flexible tube, may be used.

33. INJECTORY. — Another apparatus, which M. Straus-Durckheim has used for the last 18 years, is figured (fig. 9) here; it is for fine injections of some

magnitude, where the clysette is too small, especially in injecting the lymphatics.

It consists of a cylindrical glass receiver (A), holding about $3\frac{1}{2}$ ounces, or a little more, with a large neck (B) furnished with an iron or steel collar, into which screws a plug of the same metal, making an air-tight joint. Through the plug or stopper passes a stout glass tube (C), with an internal diameter of $\frac{1}{12}$ th of an inch, firmly fixed to the stopper, and with the lower end reaching to within $\frac{1}{25}$ th of an inch of the bottom of the receiver (C'). Its upper extremity, which rises 9 inches from the bottom, has an iron collar (D), into which screws the similar collar of a second tube (E), of the same size as the first, but only $7\frac{1}{2}$ inches long, (being $\frac{1}{4}$ th of the height of a column of mercury, equal to the atmospheric pressure). Besides this, there are two other tubes of the respective lengths of 4 and $7\frac{1}{2}$ inches; lastly, there is a cylindrical funnel (F), the calibre of the enlarged part being $\frac{2}{5}$ ths of an inch, and the length about 4 inches; the narrow portion is 2 inches long, and is otherwise similar to the rest of the tubes; with these it serves to increase the height of the column, according to the force with which the injection is to be impelled.

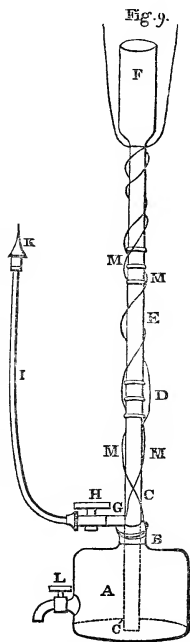

A flexible tube fixed to the stopper, and having the funnel at its upper extremity, may be substituted for the elongating pieces of glass tube. This tube, which should be about 30 inches long, (giving the atmospheric pressure), may be lengthened or shortened, at pleasure, by raising or lowering the funnel, and thus all changes of pressure obtained without altering any of the arrangements. At the side of the glass tube, an iron one (G), about $\frac{1}{2}$ th of an inch in diameter, passes through the stopper, opening at once into the receiver. This tube is bent horizontally above the stopper, and upon its extremity is screwed a metal cock (H), upon this again is screwed the metal collar of a flexible tube (I), about 12 or 14 inches long, furnished with a ring at the end, to receive the nozzle (K), which simply slides on, as in the clysette.

Below the cock already mentioned, and near the bottom, is another (L), by which the receiver may be emptied; this is not absolutely necessary, but if the vessel is emptied by the neck, the outside of the apparatus gets smeared and dirtied.

The apparatus, when in use, is suspended by a double cord (M M), which is twisted round each piece of the vertical tube, to hold all together. Mercury is poured in until it rises above the lower end of the tube, and the receiver is then filled with the injection mass. The stopper having been tightly screwed on, mercury is to be poured into the vertical tube by the funnel. This metal, by its weight, tends to drive the injection out by the second tube, with a force proportionate to the height of the column. If the mass is to be kept warm, the re-

ceiver and lesser tube may remain in a bason of warm water, until the moment of using the apparatus.

Two kinds of flexible tubes must be provided, one of caoutchouc for aqueous or alcoholic mixtures, and one of linseed oil or artificial gum elastic, for fatty injections. The elastic tubes, although of such small size, are easily cleaned, by passing through them a thread with a small piece of rag attached, and drawing this backwards and forwards.

This apparatus, though particularly useful for the injection of delicate vessels, is scarcely fit for entire animals of any size, as the quantity of mercury required would make it inconveniently heavy. It may be used for mercurial injections, but the apparatus presently to be described is better for that purpose.

34. In the injection of very small subjects, such as the Mollusca, a similar apparatus of much smaller size is used, the receiver only holding about $\frac{1}{3}$ rd of an ounce, and the stopper being made merely of cork. Both tubes are of metal, and the flexible tube fitted on without the intervention of a cock, and as the quantity of mercury required is very small, the funnel is conveniently replaced by a small bladder. While the apparatus is not in use, the bladder must be kept on a level with the receiver, so that the weight of the metal may not act upon the mass of the injection, which renders the cock unnecessary. When about to inject, the bladder is raised by a string passing over a pulley, and its height adjusted according to the force required for filling the vessels.

35. GLASS TUBE FOR INJECTING WITH MERCURY.—For this purpose a simple glass tube is often used,

12 inches long, with a calibre of about $\frac{1}{4}$ of an inch, bent near the bottom at right angles, and forming a branch rather less than $\frac{1}{3}$ rd of an inch long, into which fits (either merely slipped in, or secured by wax) a jet made of glass tube drawn out to a very fine point. The tube is filled with mercury, and this flows out by its own weight, which is adjusted by inclining the tube. This is the simplest and most imperfect form of the apparatus, but it has received several improvements— Among others, an elastic tube has been fitted to the short branch to direct the jet more conveniently; a cock is also sometimes interposed, made of iron or steel. The glass jets being very fragile, steel ones are commonly used, and the tube is occasionally suspended, instead of being held in the hand. By all these little changes the apparatus has been rendered very convenient, and almost all anatomists use it.

36. M. Ehrmann, of Strasbourg, has still further improved it, by adapting a support, called a *fixateur* (fig. 10). It is described and figured in the *Annales des Sciences Naturelles*,

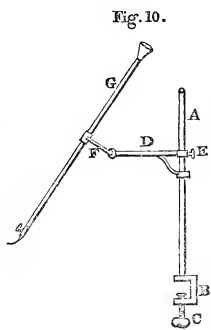

tome III, pl. 21. This apparatus consists of an iron rod (A) well hammered (as it has to sustain considerable weight), about 30 inches long, and 7 lines in diameter; this is fixed into a clamp (B), by means of which it is fastened to the table. The rod has an arm (D) of the

form represented in the figure, 8 inches long, capable

of sliding up and down or round the tube, and with a pinching screw (E); it has another piece attached to it by a ball and socket joint, also with pinching screw; this second piece is in the form of a pair of forceps (F), each arm of which terminates in a hollow half cylinder, forming together a ring to hold the glass tube (G); another screw keeps these arms fixed together.

37. FLEXIBLE TUBE FOR MERCURIAL INJECTIONS.—This is a very simple apparatus, which will be advantageously substituted for the above, being cheaper, less likely to be broken, and easier to manage. It consists simply of a caoutchouc tube, 24 inches long, and $\frac{1}{8}$ th or $\frac{1}{12}$ th of an inch internal diameter, one end having a steel collar to receive the jet, the other also having a collar into which screws another fitted into the neck of a small bladder, to hold the mercury. The whole is suspended by a cord passing over a pulley, which cord is conveniently attached to the foot of the operator, so as to leave both hands at liberty.

38. FOR INJECTIONS WITH FUSIBLE METAL.—Tubes of card-board suffice, $\frac{1}{3}$ th of an inch in diameter at least; to one of these a cock made of wood is adapted, to prevent air getting into the vessels, which should be exhausted previous to injection. The cock having been fixed into a vessel, the air-pump should be applied, then the card-board tube attached and the metal poured in. If the tube be 20 inches long, the weight of the metal will carry it into the vessels, so that when the tube is filled the cock may be turned, and the metal will run in. Artificial gum elastic tubes may be used. The metal, if it contain mercury, is injected at a temperature of about 160° Fahr., if not about 260° Fahr.

39. **HYDRAULIC APPARATUS.**—For injections of very great magnitude, an apparatus, similar to fig. 9, may be used, but made of great size and of common materials; the upright tube should be so long that the weight of the injection may force itself into the vessels, and the flexible tubes may be of leather. This kind of apparatus is well suited to Plaster of Paris injections, which destroy all kinds of metal apparatus.

40. **PNEUMATIC BELL.**—This is a convenient substitute for the air pump, when, as in very fine injections, it is necessary to exhaust the vessels. It is a receiver

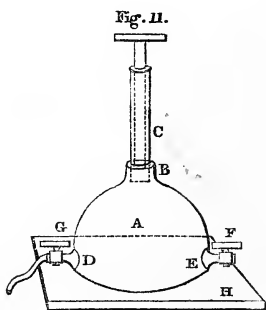

in the form of a bell (fig. 11, A), capable of holding about two quarts, having a neck (B), into which screws a small exhausting syringe (C). At its lower part, about an inch from the bottom, are two horizontal necks (D, E), at opposite sides, having a metal mounting about $\frac{1}{2}$ th of an inch in diameter; on the

outside of these, by means of a screw, either a metal cock (F, G), or a gum elastic tube may be fitted, and internally, they are adapted to receive the metal or ivory mounting of another elastic tube. The lower edge of the bell is ground accurately, to fit on a plate of glass or marble (H).

One of the cocks (F), will let air into the bell, the other (G) interrupts the current of the injection when necessary.

Into the inner end of one of the necks, as has been already stated, a gum elastic tube fits, which is only about an inch long, and terminates in another collar to receive the jet or nozzle placed in the vessel about to be injected. One cock only need be furnished with a jet, the other serving to let air into the receiver; its outer extremity has an internal screw into which is fixed an elastic tube, the end of this being plunged into the injecting matter.

The same exhausting syringe may be applied to a much smaller bell, and may be then used as a common air pump.

41. INFLATING TUBES.—These are either straight (fig. 12, A), or bent at the extremity (B), and of various sizes; it is very useful to have them furnished with a cock, and if a caoutchouc tube be adapted to them, the jet can be easily adjusted while the end is in the mouth, thus leaving both hands at liberty.

Fig. 12.

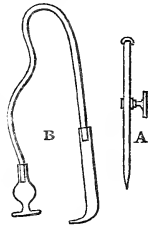

42. FINE JETS. — The common nozzles of injecting apparatus are made of brass, but these cannot be made sufficiently fine for some purposes, and would besides be destroyed by mercury. To meet this difficulty, glass tubes drawn out to a fine point, have been used, but being excessively fragile, steel ones are now generally employed.

M. Rusconi has used the quills of *partridges*, &c., for jets or canulas in injecting the lymphatics of reptiles. He introduces these in the manner of a trocar, having a

needle of moderate size, with the point finely ground, passed up the interior of the quill, to make the opening into the vessel.

43. In some cases the employment of metal syringes and jets is inadmissible, from the action of the injection matter upon them, as in some injections by chemical decomposition. Under these circumstances syringes of glass may be used, or the caoutchouc bottle (§ 29), with ivory or wooden fittings and glass jets.



SECT. II.—INSTRUMENTS FOR DISSECTION.

44. THE instruments immediately used in dissection may be divided into those which serve only as simple auxiliaries to the operation, and those which cut or divide the structures, or into non-cutting and cutting implements.

NON-CUTTING INSTRUMENTS.

45. ELEVATORS. — The table being ordinarily too low for examining small objects placed upon it, they must be frequently elevated to enable the observer to dissect them at his ease. For this purpose *props* of different heights, according to the size of the objects, which, however, are generally small, should be used, and of sufficient dimensions to admit of the hands being rested upon them. The most convenient size is 8 by 6 inches, the depth varying as may be required. A

convenient arrangement consists of three boards of equal size, placed one upon the other, each an inch deep, and united by two pegs, which pass through holes at the edge of each of the three boards, to keep them all together. But if two or one only of these be wanted, one of the external with the middle board, or the middle one alone, may be used.

46. BLOCKS.—These, which are of wood, serve to keep in any required position the bodies of animals under dissection, by being placed beneath them, so as to prevent their turning over, and should be proportioned to their size. Their form is most commonly nearly a quarter of a cylinder, resting upon one of the flat surfaces, and having the opposite angle slightly rounded. For subjects of moderate size, such as *dogs* or *rabbits*, they may be from 8 inches to 1 foot long, by 4 to 6 inches in the radius, and for very large animals, made of planks, so as to be hollow for the sake of lightness.

47. SUPPORTS.—For certain objects, such as very flat parts, which it is wished to place vertically, or round bodies, as heads, which roll about, a heavy wooden support (fig. 13, A), may be used, of a semi-cylindrical form, having upon the middle of its convex surface two round pegs (B B), placed side by side a little distance from each other, and at an angle of about 50° . These are slit down to about the middle of their length, and an iron plate placed between them, which serves to enlarge the intervening space, if necessary.

Fig. 13.

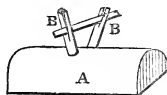

For bodies of moderately small size, this support should be about 6 inches long by $3\frac{1}{4}$ inches wide, and the pegs $1\frac{1}{4}$ inch or more, by $\frac{1}{4}$ or $\frac{1}{2}$ an inch in diameter, and placed at the distance of 1 inch from each other, the iron plate being 4 inches long by $\frac{1}{2}$ an inch wide.

These supports are of the greatest use for keeping objects in any required position, which are placed either in front or between the pegs, and fixed there by means of hooks (¶ 63) conveniently arranged, and steadied by weights attached to them. Three of the hooks one on the right and another on the left, and a third passing betwixt the two pegs, and pulling in front, form a convenient arrangement, by which parts otherwise the most troublesome are kept perfectly motionless.

48. As it very frequently happens that the hands, and even the arms, must rest upon the subject during dissection, which if rather small would be thereby dirtied, flattened, and crushed, to obviate these inconveniences, a kind of square trough, open at both ends, may be used, beneath which it is placed, and thus covered as by a bridge. These bridges, of very different sizes, should be of a depth just sufficient to clear the subject from above, so that the hand placed upon them may not be far removed from it, and to this effect also the anterior part of the opening through which the object projects should have a thin sloping edge, not exceeding the eighth of an inch in thickness. In using these troughs, the greater part of the subject may be enveloped in damp cloths, to prevent its drying or getting soiled.

49. DISSECTING BASINS.—It is necessary to dissect animals of small size, such as Mollusca and Insects, under water, as in this way not only are their organs and colours better seen and more clearly distinguished, than when exposed to the air; but the former, instead of adhering together and drying up, are detached and floated out, and may be then easily removed, either by agitating or blowing upon the water, or with a brush.

For dissecting in this manner, basins of different sizes are used, which should be proportioned to the size of the objects, though many anatomists employ the first vessel at hand for this purpose. Cylindrical troughs of zinc, tin, earthenware, or glass are best: the first kind, for the larger animals, are from 14 inches in diameter to 4 or $4\frac{1}{2}$ inches in depth, and the glass ones $2\frac{3}{4}$ inches wide, by $1\frac{1}{4}$ inch deep; care being taken that their bottoms, both within and without, are as straight as possible, so that the pieces of cork introduced may not shake about. In the absence of the above, common tumblers may be used, having their bottoms raised by some body, flat upon the upper surface, placed inside them. These glass troughs are preferable to opaque ones, from being transparent, and allowing the light to penetrate their sides. The glass troughs may be made in a square form, of pieces of plate glass cemented together by the marine glue (§ 145), or Canada balsam; all small troughs should be ground flat on the upper edge, as they may then be covered by a plate of glass when left for a time, which will be found a great convenience, not only in keeping

the preparation unsoiled, but hindering the evaporation of the fluid ; this, if spirits be used, will be of no little importance.

50. CORK PLATES.—For fixing objects, very minute ones excepted, at the bottom of the basins, pieces of cork permanently fastened to plates of lead, to keep them under water, are used. The smallest of these plates, round or octagonal in form, should be about 2 inches in diameter by $\frac{1}{6}$ th of an inch in thickness, with the layer of lead at least $\frac{5}{8}$ ths of an inch thick, so as to give sufficient steadiness to the cork ; the largest, used for dissecting good sized Mollusca and Crustacea, should be about 16 inches long by 8 inches wide, the cork being $\frac{5}{8}$ ths of an inch and the lead 1 inch thick, with their angles truncated. The two plates are fastened together with hot Burgundy pitch, and covered, for white objects, with black silk, and for those of a dark colour, with some of the same material in white.

51. For opening easily the bodies of vermiform animals, such as Annelida, Entozoa, and especially Myriapoda, without disarranging the solid parts and injuring the soft organs, they should be fixed previously upon long narrow semi-cylindrical plates, to the convex surface of which they are attached with pins, and may thus be readily handled without displacing anything, while the legs hanging along the sides may be also kept immovable.

Small plates with a round opening in the centre are useful for viewing membranes stretched across them, by transmitted light.

These plates may be elevated in the water, if re-

quired, by means of lead or tin rings placed beneath them.

Some anatomists are in the habit of using plates of wax about a quarter of an inch thick, which are sunk by weights attached to them, or troughs, with the above substance melted into their bottom; but neither of these contrivances are so neat and convenient as the cork plates.

52. ANATOMICAL MOULDS.—This name is applied to a contrivance for fixing certain bodies, which, from their peculiar form, either round or otherwise, are with difficulty kept in place. It consists in pouring plaster around them, which, hardening, encases the object like a fossil in its rock.

If the body is rough externally, or furnished with hairs capable of sticking firmly to the plaster, it is sufficient to mix a little of the latter to about the consistence of thin cream, and begin by coating over the parts to be fixed, making it penetrate as well as possible into all their intervals. That being done, this portion of the body is dipped into a larger quantity of the same material, of a pulpy thickness, and is placed either in a small box, or simply in a card turned up at the edges. The plaster, having set, is cut away where there is too much, and as much of the body as required, removed with a knife; after which the whole is placed in a basin of water for dissection, where it is steadied sufficiently by its own weight.

These moulds may be coloured with ink or some other dark fluid, if their whiteness fatigue the eye.

When there are no parts like those already mentioned

by which a body can be kept of itself in position, artificial ones are made by hooking on very small and curved-pointed pins, the heads of which are placed in the plaster while yet soft, and adhering there, keep the different structures extended, while the plaster prevents them from changing form. These moulds may be kept with the preparations upon them for years, in alcohol or any other fluid upon which the plaster does not act.

53. SKELETON FRAME.—For *mounting* skeletons, M. Rousseau, Principal of the Anatomical Department in the Jardin des Plantes, has contrived an apparatus which serves as a temporary support for subjects of very different dimensions, until their permanent one is made. It

Fig. 14.

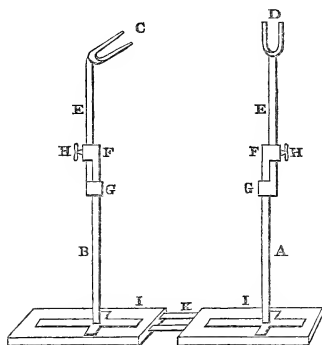

consists of two square and vertical iron rods (fig. 14, A, B), one of which is intended to support the anterior part of the vertebral column, which rests by the sixth or seventh cervical vertebra between two prongs (C), slightly diverging from its upper extremity, and directed obliquely upwards and backwards, while the

other receives the lumbar portion in a similar bifurcation (D), situated on a line with the main stem; in this position the ribs, pelvis and limbs, are easily attached. As the rods are to vary in height according to that of

the animal, each is formed of two portions, crossing and sliding upon each other, in a manner readily understood without further description from the figure (EFG), and thus admit of being shortened or elevated as required. The two pieces are fixed by a pressure screw (H). The length of the apparatus is varied by fixing each support upon a separate and rather heavy stand (II), which by means of two laths or slides (K), fastened to one of them, and traversing the thickness of the other, are separated or approximated as needful.

54. PIPETTES are commonly tubes of glass or metal, with a small opening below and a large bulb in the middle, used for drawing up fluids. This is either done by plunging the lower end in the liquid and inspiring from above, when the liquid fills the dilated part of the tube, and may be retained there by placing the thumb upon the upper orifice, and emptied, by its removal; or, if the fluid be deep, by immersing the pipette above its expansion, it is filled, though more slowly, by the atmospheric pressure alone.

These pipettes are of different dimensions. The largest, used more particularly by chemists, are 1 foot long, the first third being a straight tube $\frac{1}{4}$ of an inch in diameter, and terminated by a cone of $\frac{1}{2}$ an inch, having at the apex an opening of $\frac{1}{25}$ th of an inch; the second third of the instrument, or its belly, is a cylinder $\frac{3}{4}$ ths of an inch wide; while, lastly, the third part forms a tube $\frac{1}{4}$ of an inch in width, ending in a small mouth piece. The above serves for gradually raising up water containing objects, without

disturbing them. A second kind, similar to the preceding, but without a bulb, does for smaller quantities of fluid.

55. BRUSH PIPETTE (fig. 15). — For raising very small quantities of water very fine camel hair pencils, constructed in a peculiar manner, are sometimes used. They are about $\frac{1}{8}$ th of an inch thick in their middle; the lateral hairs (B) are about $\frac{1}{4}$ th to $\frac{3}{8}$ th of an inch in length, whilst those of the centre, $\frac{1}{4}$ th of an inch longer, form a small point (C), $\frac{1}{25}$ th of an inch in thickness. Having been previously moistened and pressed out, to render its power of capillary attraction more active, the point is

Fig. 15.



dipped into the water, which mounts up and fills the intervals betwixt the hairs.

56. PROBES. — These must be of different sizes, for exploring the direction and depth of cavities. The strongest should be round and well polished stems of whalebone, 12 to 16 inches long, and $\frac{1}{8}$ th of an inch in diameter, terminated by a leather ball.

Others, elastic and hollow, of the same width or less, in which a wire is inserted to support them, serve more particularly to introduce liquids or air into cavities.

Others, still much more delicate, consist of very soft iron, brass, or silver wires, and occasionally the finest hog's bristles or horse hairs are used; but the best of all are the spines of some Mammalia, which being conical, are strong at their base, and terminate in an acute point. Those of the porcupine are in this respect very useful.

These delicate probes should be tipped at their large end with sealing wax, so as to be easily seen and not lost.

57. THERMOMETER.—As it is frequently necessary to determine the temperature of certain parts in the living body, or that of injections, &c., it is convenient to possess a good thermometer, which should necessarily be very small, so that it can be introduced into the narrowest cavities, and at the same time easily cleaned. The best are entirely of glass, and have the degrees marked upon the same stem which contains the mercury; the scale should range from about 50° to 300° Fahrenheit. The above very simple instrument fulfils all the required conditions.

58. GALVANIC APPARATUS.—It is well known, that to produce muscular contractions in certain very irritable animals, as the *frog*, it is sufficient to touch the muscle with a small plate of copper, and the nerve supplying it with one of zinc, or *vice versa*, and join them by their free ends, when at the moment of contact of the two metals the above result takes place. But, besides this simple contrivance, it is convenient also to have an apparatus of more or less power, according to the experiments to be made, and one in particular very small, for the special investigation of the tissues or organs of minute objects.

59. INSTRUMENT FOR APPLYING LIGATURES.—As it often happens, while injecting, that vessels situated deeply, and where it is difficult to reach them with the fingers, must be tied, two very simple instruments may be made use of, by means of which ligatures can be as readily applied as on the surface of the body.

One of these (fig. 16), intended for tying vessels which are ruptured at the side, consists of a small straight stem of steel about $2\frac{1}{2}$ inches long, supported on a handle somewhat longer.

Fig. 16.

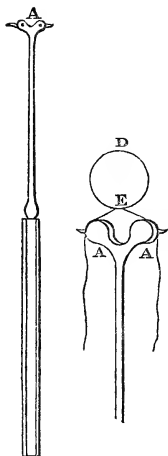

It is terminated above by a transverse piece (A) resembling the branches of an obtuse Y, and each of these about $\frac{1}{4}$ inch long is slit deeply into two parts, between which is placed a small and very moveable pulley. The head of this instrument is a little bent, so that the plane of the two pulleys forms an angle of about 25° with the stem; and from the outer arm of each pulley a small and slightly curved piece projects, turned at the end towards its fellow on the other side, so that a groove is formed by each of these projections, which is directed parallel to the stem.

In using the above instrument the ligature (D E) is passed in the usual way beneath the vessel, and the first turn of the knot made; the two ends of the thread are held tightly together between the thumb and index finger of the left hand, and the head of the instrument being next placed between them, they are made to slide over the pulleys, the lateral projections passing over them, so as to prevent their slipping off the former; and in this position the turn of the ligature is pushed towards the vessel which is thus closed, as tightly as may be wished. A second and third turn being made, the knot is completed.

60. PORTE-NŒUD.—When a vessel is divided transversely, and presents only a very small free extremity, an instrument is employed for applying a ligature, different from the one just described, which is only applicable where the vessel is not cut across.

This instrument (fig. 17), one portion of which serves to fix the end of the vessel, and the other to pass the knot around it, is composed of a hollow cylindrical stem (A), about 8 inches long, and nearly $\frac{1}{4}$ of an inch diameter, terminated behind either by an oblique handle, or simply by two rings (B) in a line with each other, for passing the two last fingers of the left hand through, while the stem is held by the rest. At its anterior extremity are two lateral steel branches, from $1\frac{1}{4}$ to $1\frac{1}{2}$ inch long (C C), directed slightly outwards, and which, being elastic, have a tendency to spring together. Each of these, supports in front a small, moveable, free and flattened hook (*d d*), the concavity of which is only $\frac{1}{25}$ th of an inch wide, and a little deeper, while it is about $\frac{3}{8}$ ths of an inch broad; it has beneath a second hook (E E) rounded, with its apex directed forwards. The piece which supports these two hooks turns upon the steel stem by an axis (I I), which allows the hooks themselves to turn inwards, so as to come in contact by their free borders, while in the extended state they are turned outwards.

Fig. 17.

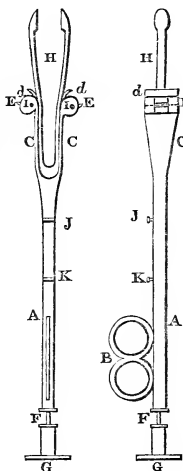

Within the main stem is placed another (F), terminated behind by a nut or ring, which serves as a handle (G). Its anterior extremity is prolonged into two lateral and very flexible steel branches, slightly curved towards each other to form a pair of pincers, and leaving a space, when unused, of rather more than $\frac{1}{2}$ an inch between their extremities, which are small and oval, convex without, and flattened within, so that they may approximate closely when shut, and be then equal in width to that of the space between the two pieces which support the hooks, beyond which they project, when pushed forwards, about $1\frac{1}{4}$ inch. These pincers can be drawn back into the external tube behind the two hooks, so as to admit of the latter bending inwards. In using this instrument the pincers are pushed forwards, which causes the hooks (d, E) to become everted, and the first turn of the ligature is then passed into the groove formed by each pair of hooks, in such a manner that the forceps pass through the loop formed by the thread. The instrument is held in the left hand, and the two ends of the thread rolled round the index finger to keep them slightly extended. The end of the vessel is then seized by the forceps, which close upon it as the outer stem is pushed over; the forceps having thus got behind the hooks, the latter bend inwards, and allow the loop to escape and slip over the vessel which, thus encircled, is tied by the instrument mentioned in the foregoing section.

Two turns of the knot may be made at once by leaving a space between them, and for introducing the *ligateur* (§ 59), more easily betwixt the threads, the stem supports in its middle two small transverse bars

$\frac{1}{4}$ inch long (J, K), having a groove upon the lateral edges to keep the ends of the thread separated behind the two twists; on pushing up the second knot, the threads escape from the bars, the head of the *ligateur* being wider than the latter.

61. PINS FOR FIXING OBJECTS.—Common pins being of brass, badly pointed and bending too readily when stuck into cork or hard bodies, may be conveniently replaced by simple sewing needles, to which large heads of sealing wax or enamel are fixed. The first of these are the easiest made, but most liable to break, while enamel requiring great heat with the blow-pipe to melt it, forms very durable heads.

62. BRACES.—These, which should be of different lengths, are formed by pins, with or without heads, bent into a hook at their large end, and may be readily made as wanted. They are very useful for keeping in place bony or horny parts, shells of Mollusca, and particularly the valves of the Acephala, which are difficult to transfix. For example, in order to fix upon a piece of cork an acephalous Mollusc contained in one of its valves, which from its convexity is otherwise no easy matter, three of these braces are planted round it, the hooks of which catch upon the edges of the shell, and thus fix it firmly, without being in the way of the dissector.

63. HOOKS.—Two kinds of hooks are commonly used in the medical schools for holding, fixing, or separating different parts. The one which has been longest in use, is a small plate 2 to 4 inches long, by $\frac{3}{8}$ of an inch wide, and $\frac{1}{12}$ th of an inch thick, armed at each end with one

or more frequently two hooks placed laterally, one pair of which serves to hold the part, while the other is fixed to the body itself, or some resisting material. The stem is generally slender and spindle-shaped when there is only one hook.

The second kind is a small round stem $1\frac{1}{2}$ to 2 inches in length, terminated at one end by a sharp hook and at the other by a ring, through which a finger of the left hand passes and draws up the part transfixed. Though less fatiguing to the hand, and retaining parts more securely than the forceps, it may be used along with the latter in keeping small structures extended for division, by the little finger of the left hand holding the hook by its ring, while the forceps are taken between the thumb and index, the two last may be sufficiently separated from the little finger to effect the required degree of stretching.

A third sort of hook is principally used in dissecting large animals, where forcible traction is required. It is commonly a double hook, mounted upon an octagonal wooden handle. The smallest should not be less than 6 inches in its entire length, and the hooks ought to form a semicircle of about $\frac{3}{8}$ ths of an inch radius; the largest 8 inches long, and the hooks $1\frac{1}{4}$ inch in diameter.

A simple hook, terminated at one end by a small ring, to which a cord of variable length is attached and fastened to a weight, proportioned to that of the object under dissection, is also useful.

64. DISSECTING FORCEPS are of different kinds, but those most commonly used in dissecting rooms, and too well known to need any lengthened description, are,

when carefully constructed, perhaps the best. In some, the branches are made rough externally, like a file, which possesses no peculiar advantage, and only serves for the lodgment of rust and dirt. Other kinds have the two blades slender and flat, instead of pointed at the apex.

The spring forceps are simply the common ones, one of the branches of which has a spring fixed to its anterior third, and traversing a hole in the opposite branch, to which it hooks by a catch when the instrument is closed, and by being pushed forward allows it to open. The above forceps, for very large animals, should be nearly 8 inches long, so as to be held in the hand.

For minute objects, the first variety of forceps, only smaller (about 3 inches long), may be used. There should be no roughness within upon the extremity of the blades, which should be slightly curved upon themselves and towards each other, and close easily, so that in using them with the microscope, the hand may not oscillate. The branches, very thin, should be wide at their base, so that the points cannot cross each other.

It is almost needless to observe, that these instruments should be well tempered, the points neither too hard nor too soft, and adjusting most accurately by the notches on their inner surface to each other, without which bodies will slip from between them.

A third variety of forceps is serviceable in the dissection of very large animals, where the constant and forcible pressure that must be exercised upon their branches, to support heavy masses, would soon become insupportably fatiguing. The blades (in other respects

resembling the ordinary kind, only with broad points) are slit longitudinally, to admit of a slide with a nut at either end, which being pushed forwards keeps them from separating. This instrument is used also for compressing ruptured vessels during injection, when a ligature cannot be directly applied.

A modification of the above consists in having the branches larger, and fixed to wooden or horn handles, so as not to be too heavy, and measuring about 4 inches long, and 1 across. Behind, the two handles are united by a curved spring, which tends to separate while a slide glides too and fro upon them. The anterior part is about $3\frac{1}{2}$ inches long, and differs only from that of the common forceps in having internal prominent teeth, which extend over a length of $1\frac{1}{4}$ inch.

65. CROSS-PINCERS, (fig. 18).—This kind of forceps

Fig. 18.

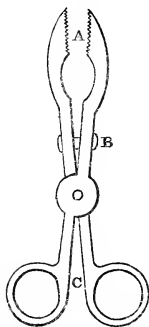

may be used instead of the preceding, and for like purposes. They have the form of a pair of scissars, the blades of which, in place of crossing and cutting, are semi-cylindric, and applied by their flat surfaces against each other, while they are slightly curved in front, so as to meet only at their extremities (A), which are furnished with sharp teeth, increasing in size from before backwards. The anterior of these serve for laying hold of a small part, the posterior or larger for heavy masses.

The instrument is kept shut by a running slide (B), placed between the branches.

66. **LEVERS.**—These are necessary for disarticulating the bones of the cranium, by being forced between the sutures, and for this purpose small chisels, like those used by sculptors, but with a blunt edge and curved longitudinally, may be advantageously employed.

CUTTING INSTRUMENTS.

67. **CHISELS** of different kinds should be had for cutting into bones and other hard bodies, to trace their vessels and nerves; some, for instance, with a very sloping edge, for planing, others less so for cutting and splitting parts.

68. **SAWS.**—Of these there are three principal varieties used by the anatomist.

The first and smallest is formed like a watch-maker's saw, with the blade about 5 inches long, and so constructed that it may revolve upon its axis within the frame.

The second kind is larger, though nearly the same in shape, but its blade can be tightened, like the string of a bow, by a screw placed in the handle; it should be about a foot long by $\frac{5}{8}$ ths of an inch wide, and also move in different directions.

The third saw, larger than the first two, is intended for cutting deeply in situations where the two preceding could not, owing to their frame-work, penetrate. It is simply a very broad blade of steel, stiff enough to support itself, and furnished at its posterior extremity, where it is widest, with an oblique wooden handle. It is commonly from 8 inches to a foot long, by 2 to 3 inches broad at the base, and 1 to $1\frac{1}{2}$ inch across its anterior extremity.

To give the saw more stiffness, it is supported along the back by an iron or brass rod, grooved beneath, into which its whole length is received. This frame is moveable upon the handle, and can be elevated from off the back, so as to be no obstruction to the passage of the blade when the slit made by it becomes deeper.

69. HATCHET.—Bones are often more easily cut by this instrument than by the saw or chisel. A small and well sharpened one should be used, the blade of a triangular shape, the handle passing through the apex, which is prolonged upon the opposite side into a narrow, transverse, square and blunt anvil, for breaking parts or acting as a lever to separate them.

70. BONE-NIPPERS.—The general form of this instrument, which is intended for cutting hard bodies, such as bones, cartilages, and horn, is that of a pair of scissars with long branches, but with very short, strong, and wedge-shaped blades, not a quarter the length of those of scissars, which, instead of crossing, meet like cutting pliers.

71. SCISSARS.—Those used in dissection differ only from the common kind in having the handles straight and parallel to each other. One of the blades should be sharp and pointed, for penetrating between organs, the other blunt and slightly truncated at the extremity for displacing parts without cutting. Scissars, with blades curved either in the direction of the plane of the instrument or in the opposite one, may also be used.

Two different sizes at least should be had, one employed in dissecting large animals, about 6 inches long

and the blades 2 inches; the other smaller, only $3\frac{5}{8}$ of an inch, and the blades $1\frac{3}{8}$ of an inch in length.

72. MICROTOME, (fig. 19).—The difficulty of cutting with steadiness and precision very small objects with scissars, suggested to M. Straus-Durckheim the idea of the present instrument, which so completely fulfils the required conditions that it is the principal one which he uses for delicate dissections, and without which, indeed, he says, careful preparations of minute animals could hardly be made. The body of the microtome (C) resembles dissecting forceps, in being formed of two flat branches united at their posterior extremity, and separated in front by their own elasticity. Each of these is terminated by a small and rather broad scissar-shaped blade (A), the plane of which is perpendicular to that of the branch. From this simple arrangement of parts alone, it is plain that by pressing upon the microtome with the fingers it will close, and open again when the latter are removed, with a spring; while, at the same time, its movements are far more exact than those of ordinary scissars, from the force being applied very near to the cutting points. But, besides these advantages, as it is often required for making very small incisions, some contrivance is necessary for previously approximating the two blades to an extent proportionate to that of the space to be passed over, and this is effected by means of a screw (D) fixed at the anterior extremity of the handle to one of the branches and traversing the other freely (B), while a nut

Fig. 19.

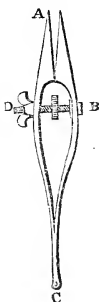

placed externally, serves to diminish the angular interval betwixt the two points, which thus adjusted divide only as much as is wished, without acting upon other parts. A second nut, placed upon the screw between the two branches, limits the degree to which the latter should cross, so that parts may not be torn by too hasty a movement.

The two blades of the microtome are united behind by a hinge, in order that they may separate freely to be sharpened. The entire length of this instrument, which is held exactly like a pair of cutting pliers, is $4\frac{3}{4}$ inches, and that of the blades $1\frac{1}{4}$ inch; the breadth of the branches posteriorly, $\frac{3}{8}$ ths of an inch, and $\frac{1}{4}$ inch only in front. As to the blades, it is best for them to be rather wider ($\frac{1}{4}$ inch) and strong, so as to last a longer time.

73. SLICE.—For making large and clean sections of very soft substances, as the brain, a long and very broad bladed knife is used, with a very keen edge like a razor, but harder, and fixed into a handle similar to that of a table knife. The largest should have a blade at least 8 inches long by $1\frac{1}{4}$ inch wide, and the smallest $3\frac{1}{4}$ inches by $\frac{3}{4}$ broad. A common razor, however, may be used very well instead.

74. SCALPELS.—Those generally employed in medical schools are about $6\frac{1}{2}$ to 7 inches long, the blade occupying about $2\frac{1}{2}$ inches, the handle slender towards its extremity, terminates in a rounded spatula for displacing certain parts without cutting them, and is generally oval or square; the latter form, as being more securely held between the fingers, is preferable.

The blade may have one or two edges, but the latter

kind are objectionable for many reasons. Those with a single edge are distinguished into two varieties—the straight and the curved edged. The first, the most pointed, are particularly suited for the dissection of small animals, where the extremity of the blade is almost the only part used; while the second, with a convex edge, are most adapted for large animals, where long incisions require to be made. For very large mammalia the entire length of a scalpel should be about 8 inches.

75. SCRAPERS.—For cleaning bones or removing hair or horny textures, old scalpels may be used; but as they are generally pointed, and scratch the bodies to which they are applied, it is best to employ instruments for the special purpose, which have a handle like a small scalpel, and the blade terminated in a round and lancet form. These will also serve conveniently for *prizing* open sutures, or slitting up resisting textures, where a scalpel would break.

76. DISSECTING NEEDLES.—These instruments resemble in their length, and the octagonal form of their handles, small scalpels, the steel of which terminates in a point, instead of a blade. There are two varieties of them—the straight pointed, which serve for very fine dissections, and the curved, which are used for animals not strictly speaking microscopic, such as insects. The latter kind are bent nearly into the fifth of a circle, the radius of which should be $\frac{1}{6}$ th of an inch, and are absolutely indispensable in dissecting small animals, from the facility with which their point can be turned in every direction, by varying but slightly the position of the hand. With these curved needles and the microtome, M. Straus-

Durckheim made all his minute dissections. Two of the straight kind must be provided, for they are most frequently used together.

77. SETTING SCALPELS.—Bearing in mind that a cutting edge is the apex of a cone, more or less elongated, it will be easy for any one to judge of the various degrees of inclination to be adopted in gliding along the surface of the hone, keeping the edge foremost, so as to gather the oil spread on previously; this must be done alternately to each side, holding the instrument steadily, but still with a light hand. If it is for cutting cartilage, the back of the scalpel should be held above the level of the stone at an angle of 30 degrees; if for cutting a delicate membrane, the back should be held so as to touch.

It is a very common practice to lay heavily on when setting: this is bad, it having a tendency to produce a wire edge, which entirely prevents the instrument from cutting. If the edge should be blunt, a Turkey stone is to be made use of first, then a German hone, and finally a green hard stone (called “Charley Forest”), which is found in some parts of England.

For setting scissars, or any instrument having the same form, it is only necessary to pass the oil-stone in one direction on the bevelled edge of each blade; doing anything to the surfaces which come in contact would irreparably injure them. To instruments not much blunted, razor paste spread on a strop or a piece of smooth hard wood will give a fine edge.*

CHAPTER III.

SUBSTANCES USED IN PREPARING AND PRESERVING
ANIMAL STRUCTURES.

SECT. I.—INJECTIONS.

78. THE different kinds of injections used by anatomists may be conveniently divided into three classes, viz., 1. Common or coarse injections; 2. Fine injections; and, 3. Injections for corrosion. The *first* are used to fill large vessels, into which coarse substances may be easily made to flow. The *second* are composed of finer materials, and are used when it is intended to trace the capillary vessels. The *third* class are frequently somewhat of the nature of the first; but this division includes the fusible metals, plaster, &c.

79. *Common Injections* should be solid at ordinary temperatures, so that they may not escape from the vessels when cut into; at the same time, they should be fluid at the temperature of about 110° Fahr., which heat is not sufficient to affect the tissues of organs to any great extent. When solid, the mass should be moderately hard, not brittle, and rather tough, so that the vessels may be moved without breaking. Wax is generally the basis, and its hardness and want of fusibility is diminished by mixing it with either oil, tallow, or

lard. The best oil is that of the poppy, cold drawn, it being less viscous than ordinary oils.

The colours used are simply held in suspension, and must be powdered very finely, so that they may neither be too quickly deposited, nor cause any resistance to the fluid in the finer vessels.

80. In *fine* injections, it is necessary to be very careful, both in choosing the ingredients, and in ordering their proportions in the mass; the principle condition they should present, is great penetrating power. These masses ought generally, like the first class, to become solid after a time, but this is not of so much consequence in vessels of extreme tenuity, as their capillarity enables them to retain the fluid; they must however be very *flowing*, and not in the slightest degree viscous at the temperature at which they are used.

A great number of compositions have been proposed for fine injections, each having its advantages, according to the peculiar circumstances under which it may be required. They are oily, gelatinous, metallic, aqueous, spirituous, &c., each of which will be considered in its turn. The colouring matter must be as finely powdered as possible for ordinary fine masses, and for very minute injections it must be in solution, so as not to interfere with their fluidity. Preparations made with these latter can only be used in certain cases, as they lose their colour after a time, by its being dissolved in the preservative solution.

In preparing a fine mass great care must be taken not to allow any foreign matter, such as dust, &c., to become mixed with it, as it will certainly get into the nozzle of the syringe, and cause an obstruction.

81. COMMON INJECTIONS.—The following receipts, include most of those commonly in use, many of them are only slight modifications of each other.

Tallow coloured by vermilion, or other insoluble matter, forms the cheapest kind of injection; this can only be used to fill the larger vessels, in subjects not intended to be preserved.

82. Tallow, 3 oz.; burgundy pitch, 2 oz.; Venice turpentine, 1 oz.

83. Tallow, white resin, each, 16 oz.; wax, 3 oz.; Venice turpentine, 2 oz.; essential oil of turpentine, 1 oz.

84. Purified tallow, 2 lbs.; wax, 1 oz.; Venice turpentine, 4 oz. This composition is very penetrating, but allows the colour to settle quickly, which may be remedied, in some measure, by adding to it, spermaceti, 4 oz.

85. Tallow, 12 oz.; wax, from 3 to 6 oz.; spermaceti, 4 oz.

86. Tallow, 12 oz.; white or yellow wax, 5 oz.; olive oil, 3 oz.

87. Wax, 12 oz.; Venice turpentine, 6 oz.; tallow, 3 oz.; essence of turpentine, 1 oz.

88. White or yellow wax, 8 oz.; black resin, 4 oz.; turpentine varnish, 3 oz.

89. Spermaceti, 2 oz.; wax, 1 oz.; Venice turpentine, 1 oz. (A very penetrating injection.)

90. The common mass, that used by M. Straus-Durckheim, consists of white wax; tallow, each 4 parts; and Venice turpentine, 1 part. These are well melted together, and the colouring matter added, the whole is then strained through a linen cloth. For the tallow may be substituted lard or poppy oil; in that case only 3 parts of either of these must be used, or the mass

would be too soft. Yellow wax may be used instead of white.

This, and all other injections which require heat, should be prepared in a water bath, by which, not only a more equable heat is obtained, but it is more free from danger, and keeps the mass fluid for a longer time after it has been removed from the fire.

Ordinary fatty injections require rather a high temperature to melt them, and also set rapidly, which causes a double inconvenience, viz., that they are disagreeable to handle, and unless used very quickly will set either in the apparatus or in the large vessels, leaving the smaller ones empty.

91. The following mass may be sometimes employed, which is used cold, and does not set for several hours after it has been injected. It is simply *elai-dine*, coloured by some substance not affected by nitric acid. To prepare it, take of olive oil, 100 parts; nitric acid, 9 parts; and nitrous acid, 3 parts. These are well mixed by shaking the bottle containing them, the colouring matter is then added, and the injection proceeded with. If the olive oil is very pure, this mass sets in about 70 minutes, but if it contain only $\frac{1}{100}$ th part of poppy oil, the solidification will be retarded for nearly three quarters of an hour. This mass swells in setting, becoming porous, and presenting little consistence; once solid, it melts at a temperature of about 85° Fahr., and will not set again for several hours, which allows of its being prepared beforehand, and injected either tepid or cold. Of course *metal* instruments would be destroyed by the nitric acid in this composition.

92. In similar circumstances, instead of the above, may be used the cold paint injection, which consists of white lead ground with oil, as sold at the colour shops, thinned with turpentine varnish, until of the consistence of paint. This is only to be used in preparations intended to be dried; it hardens in three or four hours.

93. FINE INJECTIONS. — For preparations to be preserved, the best substance is gelatine dissolved in water. Take in winter 7 parts, in summer 12, of pure dried gelatine, soak them for several hours in 100 parts of pure water; when it has acquired the consistence of jelly dissolve it in the same water, by means of a *gentle* heat, stirring it constantly. It is always as well to try the mass before using it, as all gelatine is not equally good; this is done by letting a drop of the solution fall upon a cold piece of glass or stone. If the liquid is sufficiently concentrated, the drop will set in a few minutes into a weak jelly, and will become hard in about 10 or 12 hours. Gently heated this jelly or size will melt into a liquid as *flowing* as water.

The best gelatine (also the dearest) is isinglass, but for this may be substituted that prepared from bone. The substance sold as Nelson's patent gelatine would probably be useful in very delicate injections, but common size, well strained, answers very well in ordinary cases.

If the liquid is not sufficiently concentrated it should be reduced by evaporation; if already too much so, it may be diluted with water, leaving it a little while on the fire and stirring it well, so that the mixture may be homogeneous. When the solution is ready, the co-

louring matter should be added, and the whole strained through a very fine cloth. It is to be used warm.

94. In order to reduce the insoluble colouring matter to the utmost state of division, it should be powdered by the process indicated in the article on colouring matter (§ 109), in the same water that the gelatine is soaked in, by which means the exact tint is obtained, and at the same time the colour does not settle.

This fine injection may be preserved in the state of jelly, keeping a film of rather strong alcohol on its surface; when wanted for use, the alcohol must be poured off, and the surface of the jelly having been well washed with cold water, it is to be melted by a gentle heat. It may also be evaporated to dryness, and kept in that state; it will then have to be treated in the same manner as the pure gelatine.

95. White of egg may sometimes be advantageously used as a fine injection. One part of the white of egg is mixed with two parts of water, the mixture well shaken, and allowed to remain some time, 24 hours if convenient, in order that the liquids may be thoroughly blended. This mixture must be filtered through fine linen, (the membranous residuum not being squeezed too much), and will be ready for use. This fluid is used like ordinary injections, but requires the subject to be placed in the following re-agent to coagulate the albumen and render it opaque.

This is the sulphate of the peroxyde of iron, dissolved in water (§ 120). When the preparation is placed in this solution the albumen is immediately coagulated, forming an opaque jelly, which, however, is not white,

but of a brownish-yellow colour, due to the re-agent. The injection may be coloured previously, if desirable, with any very fine substance, such as indigo, &c. ; or, if the subject is not intended to be kept, a soluble substance, such as gamboge, archel, &c., may be added to the water before it is mixed with the albumen. The solution of the sulphate must not be stronger than that indicated, or it will have the effect of re-dissolving the albumen the instant after coagulating it.

The reason of the superiority of this solution over alcohol and the acids in coagulating the albumen, is, that the solution allows an appreciable quantity of the water with which it is diluted to combine with it, while with the others the albumen swims in flocks in the water added to it.

White of egg may be kept for months, either pure, diluted with water, or dry, without losing its coagulating property. When dried, it must be dissolved in 24 times its weight of water to form the injection, as in drying it is reduced to one-eighth of its weight.

Alcohol produces a very white coagulum, but, as above stated, it is flocculent.

96. Milk makes a very good, cold, fine injection ; it must be used fresh, before the cream begins to separate ; it may be coloured in the same manner as gelatine, if required. It is coagulated, after having been injected into the vessels, by soaking the subject in weak acid for some time ; this acid may be vinegar, or either sulphuric or hydrochloric acid, diluted until no stronger than good vinegar.

97. Spermaceti, 25 parts ; Venice turpentine 10

parts ; essential oil of lavender or turpentine, 10 parts ; —form a mass with great penetrating power, which melts at less than 77° Fahr., and regains its consistence as it cools.

This oleaginous fine mass is generally useful for small subjects, such as Mollusca. Being of a fat nature, extravasation is easily removed without leaving a stain, which is occasionally a great advantage. This mass should be kept in a well stopped jar, as the essential oil is very volatile ; if any of this has evaporated (which will be seen by the difficulty of fusion) some fresh must be added to it. This mass should melt with the warmth of the hand.

98. Spirit varnish, 8 oz. ; turpentine varnish, 1 oz. ; vermilion, 1 oz. This formula is given by Mr. Knox, for fine injections : — he says, “ this injection sets very rapidly, and requires a certain degree of heat to keep it fluid. It fills extremely minute vessels, and is intended for such parts as are to be dried. The above injection will become very soft if exposed to a great heat, and would scarcely support its own weight in a preparation very minutely dissected.”

99. In preparations for mere study, not intended to be preserved, and in which it is desirable to inject the smallest vessels into which the blood or any similar fluid can penetrate, matters naturally liquid, coloured by substances held in solution, may be used, such as the essential oils, especially those of lavender and turpentine, coloured by alkanet.

Water or alcohol, coloured by any substance in solution, or any extremely finely divided substance held

in suspension. They are usually coloured with *archel* (which gives these two liquids a splendid purple colour if the water is distilled, reddish violet if it is not, and contains alkali); *madder lake*, and other colouring matters held in suspension; *gamboge* or *verdegris* when the tissues of the injected organs are not permeable by these two liquids; when the fluid is likely to be infiltrated, *indigo*.

Mercury constitutes, on account of its fluidity at common temperatures, and its conspicuous appearance, the most generally employed fine injection; but, in spite of these two advantages, and another it possesses, namely, that of not staining preparations, it presents so many inconveniences, that it cannot but be regarded as one of the worst materials that can be employed. It will not penetrate very fine vessels, and it renders those it fills so heavy, that it is almost impossible to touch them without causing a rupture, in which case all the mercury escapes; besides, it so distends them, that they are scarcely recognisable. It destroys all instruments save those of iron or platina, and moreover is too dear for common use.

100. Another process has been introduced within the last few years, which has been exceedingly useful in fine injecting. It consists in taking advantage of the power certain salts have, of decomposing one another. Thus, for instance, a finely filtered solution of chromate of potass is injected into a vessel, and, in consequence of its perfect fluidity, penetrates very minute ramifications; after a certain time another solution, acetate of lead, is introduced into the same vessel, and by the decomposition, an abundant yellow precipitate of the insoluble chromate of lead takes place.

A red precipitate is obtained by iodide of potassium and bichloride of mercury ; blue, by the ferrocyanide of potassium and peroxide of iron, &c.

From the great fluidity of these injections, very little force is required to impel them ; of course, metal instruments must not be used.

These injections are exceedingly convenient, requiring no heat or preparation, except the solution of the salts, and these solutions may be kept at hand in stopped bottles.

101. **MASSES FOR CORROSION.**—These are distinguished into two kinds, metallic and resinous.

The metallic injection is formed of D'Arcet's fusible alloy, composed of bismuth, 8 parts ; lead, 5 parts ; and tin, 3 parts. This melts at a temperature of about 190° Fahr. ; by adding $\frac{1}{16}$ th of its weight of mercury, its point of fusion is reduced to about 112° Fahr. It will then penetrate very fine ramusculi, but must not be used too hot, for fear of scorching the vessels. The injection is made by the weight of the metal itself, which is poured into a principal vessel through a tube of card-board adapted to it. It is advisable to empty the vessels previously, by means of an exhausting syringe, so that the metal, which solidifies rapidly, may meet with no obstacle.

102. The injected preparation is then placed, either in water and left to the action of putrefaction, or in a corrosive liquid, which destroys the parenchyma of the organs more rapidly.

103. Resin, 8 oz. ; white wax, 10 oz. ; Venice turpentine, 12 oz. This is less friable than the following, but also less penetrating :—

104. White wax, 12 oz. ; purified resin, 10 oz. ; essence of turpentine, 6 or 8 oz.

105. Mr. Knox proposes the following :— Bees' wax, 16 oz. ; resin (best quality), 8 oz. ; turpentine varnish, 6 oz. ; vermilion, 3 oz.

106. The following composition appears to answer the purpose best :—White wax, 2 parts ; Venice turpentine, 2 parts ; Burgundy pitch, 1 part. This mass melts at a low temperature, and penetrates very small vessels ; at the same time it is flexible, and resists well the action of the corroding liquids.

By taking equal parts of the same ingredients, a firmer mass than the preceding is obtained, tenacious, but less penetrating, and requiring a greater heat for its fusion.

107. The materials of injections made with heat should be added together in the following order :— common resin, wax, tallow, Burgundy pitch, spermaceti, hogs-lard, Venice turpentine, expressed oils, and last of all, the essential oils, on account of their volatility.

COLOURING MATTERS FOR INJECTIONS.

108. RED.—Vermilion, or carmine.

BLUE.—Indigo, Prussian blue, or Smalt.

YELLOW.—Gamboge, or king's yellow.

GREEN.—Verdegris.

BLACK.—Lamp black.

To these various substances may be added also, *madder lake*, *alkanet*, *archel*, *chrome yellow*, *Indian yellow*, and the *neutral chromate of potass*. Of these, gamboge,

verdegris, alkanet, archel, and chromate of potass, are all soluble in alcohol; the same, with the exception of alkanet, in water; and all these, except archel and chromate of potass in oily matters. The other substances are not soluble in any of these menstrua, and must be powdered for use. As these colours vary so much in their properties, it is of course necessary to vary the application of them according to the end proposed, taking care never to place any of them in any preservative solution, which will exert a solvent power on them. The soluble colours are chiefly to be used for preparations for simple investigation.

Vermilion is one of the brightest colours that can be used, but it has the inconvenience of being very heavy, and settling very fast. It does not combine well with water, however finely powdered, but it grinds up very well in any oily substance.

Carmine would be an excellent material if it were not so dear, and if it did not lose its colour at a temperature of about 100° Fahr.

Madder lake is much better, it is much cheaper, bears very high temperatures, and colours either oil, water, or alcohol, equally well.

Alkanet root is useful in colouring oils, or alcohol, for minute liquid injections; 1 part of alkanet to ten parts of liquid, digested at a gentle heat, give a good colour, though a high temperature destroys this and all other vegetable colouring matters.

Archel is a beautiful reddish purple colour, obtained from the *Rocella tinctoria*; it is soluble in water and alcohol, but not in oils.

There is no blue colour soluble in these three menstrua, and fit for the finer injections; others simply held in suspension are necessarily used, and, fortunately, there are some which may be divided so finely, that it is almost impossible to tell whether they are in solution or not; these are *indigo* and *Prussian blue*.

109. *Indigo* requires some little preparation when used for fine injections, it is not only more difficult to powder than *Prussian blue*, but generally contains foreign matters, such as sand, &c., which of course would clog delicate apparatus. Only that of the best quality should be used, known as Guatemala *indigo*, which has the richest colour, but still requires to be freed from sand. This may be done in the following manner:—The first part of the operation consists of pounding the colour, then enclosing it in a strong linen bag of close texture, and allowing it to soak for twenty-four hours in the liquid, which is to be used as the vehicle of the injection mass. The *indigo* being then well softened, it should be gently squeezed out through the linen into the liquid, until the latter has acquired the necessary tint. To get it still finer, if desirable, this liquid may be allowed to stand till the grosser particles subside, and then decanted; this deposit serves very well for coarser injections.

As water does not affect indigo, that which remains longest in suspension may be allowed to settle, and the water *nearly all* poured off. A large supply is thus obtained, which, as it will not concrete under these circumstances, will always be ready for fine injections. The process may be employed with any colour not alterable in the vehicle.

For oily injections the same method is pursued, but *Prussian blue* gives them a much better colour than *indigo*, while the latter is best for *water*.

Prussian blue is prepared in the same way, and is powdered with greater facility; being heavier, it must not be allowed so long a time to settle. A strong heat turns it green, or even brown, especially when mixed with resin or turpentine.

The colour from the last deposition is the best, about $\frac{1}{400}$ th of it will give a superb colour to oily masses. Of *indigo* a larger quantity is necessary.

110. *Verdegris*, dissolving easily in alcohol, oils, or water, is of course unfit for permanent preparations; but the same quality renders it peculiarly useful for fine injections for mere research.

The green colour for preparations to be preserved, is obtained by mixing *indigo* or *Prussian blue*, with *chrome* or *Indian yellow*.

Lamp black is the finest colour that can be found; it may be divided almost to infinity in oils, $\frac{1}{300}$ th even giving a dull black colour.

Gamboge has the same peculiarities as *verdegris*, and is used for similar purposes. The best yellow colour for injections is *Indian yellow*, being light, and settling slowly; it may be prepared like *indigo*, but is rather expensive.

For common oily masses *chrome yellow* is the best, being much cheaper than the last, but being also much heavier; it is deposited very quickly.

For preparations for study alone, a solution of neutral *Chromate of Potass* in ten parts of water, is very useful. Although limp, it colours strongly, one part

in 1,000 being still very perceptible. It is not soluble in oily substances.

111. Straus-Durckheim says, it is usual to put a great deal too much colouring matter into masses. This is in a great measure, because they are not properly powdered; for instance, Lauth indicates for *cinna-bar*, *Prussian blue*, and *indigo*, $\frac{1}{10}$ th; for *gamboge*, $\frac{1}{15}$ th; for *Cassel yellow* $\frac{1}{6}$ th; but for *carmine* only $\frac{1}{120}$ th: all these quantities are far too great. The following are what he employs, reducing them to the finest possible powder. Of *Vermilion* $\frac{1}{50}$ th of the weight of an oily injection, even $\frac{1}{100}$ th gives a very fair tint; of *indigo* or *Prussian blue*, of the very fine settlings, $\frac{1}{300}$ th gives a dark blue colour; $\frac{1}{800}$ th of *Prussian blue* gives a fine sky blue, while $\frac{1}{100}$ th makes wax appear almost black, but in very small vessels, where the mass becomes transparent, the tint is a beautiful blue.

Of *Indian yellow* and *madder lake* $\frac{1}{100}$ th, or of *gamboge* $\frac{1}{50}$ th, to get a good colour; and *verdegris* ought to be $\frac{1}{20}$ th of an oily mass.

It is difficult to fix a proportion for *alkanet* or *archel*, as they are generally impure; however, $\frac{1}{10}$ th of bruised *alkanet* ought to give a bright crimson, and, with *spermaceti*, $\frac{1}{100}$ th even a bright rose colour.

The above proportions, where not otherwise expressed, are those necessary for white wax, which is opaque, and the colours consequently rather dull. Tallow, more diaphanous, receives from the same quantity a brighter and clearer tint, while *spermaceti*, on account of its semi-transparency, takes the most brilliant, but also the least depth of colour.

Colouring matters give to resins still poorer tints than to wax, they being themselves coloured; and the colours are quite destroyed if more than a moderate heat be applied to them.

To colour gelatine or albumen, colours soluble in water are used, or which can be finely powdered, especially such as weigh least, as *indigo*, *carmine*, &c. These, when obtained in fine powder, by the process above described for *indigo*, may be preserved, as stated there, in water, and this water will do to soften and dissolve the gelatine.

The proportions of colour for watery injections are much the same as for oily ones.

To tinge gelatine or albumen, green *indigo* and some *yellow*, particularly *gamboge* or *Indian yellow* are used.

Resinous injections, for preparations to be corroded, or preserved dry, take a fine green from *verdegris*.

SECT. II.—PRESERVATIVE SOLUTIONS.

112. THE fluid most generally in use for preserving preparations of animal substances is alcohol; but as this is very expensive, and, besides, occasionally causes so much contraction as to render an object useless, many attempts have been made to obtain other antiseptic solutions. These attempts have as yet but partially succeeded; but the best of them will be mentioned. Before, however, going into the composition of the various fluids, it will be as well to consider what are the general requisites to be observed in using them.

These liquids, while they hinder putrefaction, should not be liable to contract mouldiness; they must not act chemically upon the preparations, either by dissolving portions of them, or contracting them; they ought to be colourless; those in which calcareous substances, such as bones, &c., are placed, must not be acid; neither ought they to attack the instruments used in dissection; lastly, they must be cheaper than alcohol.

113. ALCOHOL.—The disadvantages of this fluid are its price, and the property of corrugating animal structures; but, in spite of these, it is universally employed, as the only substance that can really be depended on. Rectified spirit of wine, at 60° over-proof, diluted with an equal quantity of water, is about the strength generally used; for soft bodies, it must be much weaker at first, and the preparation gradually removed into stronger. In large preparations, the quantity of fluid in the subject must be taken into account; but the best way is to place them in spirit of the usual strength, and to change it at the end of three or four weeks. Preparation jars, containing spirit, are usually tied over with two or three layers of bladder, having a piece of thin sheet lead between them, and afterwards varnished; they should be looked to frequently, as the expansion produced by changes of temperature frequently causes cracks in the cover, through which the spirit would evaporate.

114. GOADBY'S SOLUTION.—This is perhaps the best substitute for alcohol yet prepared; the composition is as follows:—Bay salt, 4 oz.; alum, 2 oz.; corrosive sublimate, 4 grains; boiling water, 2 quarts, well stirred together, and the solution filtered.

115. *Aqueous solution of alum*, in the proportion of alum, 1 part, pure water, 16 parts, preserves animal substances very well for a certain time; all the parts retaining their natural conditions to some extent, except the bones, which are acted on by its acidity. Alum, 1 part, water, 8 parts, injected into the arteries, render the gelatinous parts, and even the muscles, capable of resisting decay for a long time.

116. The tanners use a liquid which converts the gelatinous parts into an incorruptible leather: it contains—alum, 3 parts; common salt, 1 part; and water, 24 parts.

After the application of the preceding, they use a paste to give suppleness to the leather. The one commonly employed is made as follows:—

117. Maize flour, added to the solution given above (§ 116), till it has the consistence of a thin paste; then, the yolk of an egg for every six ounces of water, to be well mixed, and applied to the *inside* of the skin.

118. GANNAL'S SOLUTION—*Acetate of Alumina*.—This liquid appears to answer all the required conditions for the prevention of putrefaction; but it is as dear as alcohol, and, like the alum solution above, dissolves calcareous matter. Straus-Durckheim, however, says, that in the proportion—acetate of alumina, 1 part, rain water deprived of air, 10 parts—the flesh of a calf was wholly decomposed in less than a month.

119. *Common Salt*.—M. Al. D'Orbigny says, that the Mollusca are well preserved in salt in a dry state. It is occasionally used dissolved in water, but is very unsatisfactory.

120. *Aqueous Solution of the Sulphate of Peroxide*

of Iron has been employed for preservation ; but it attacks osseous parts, besides rendering the preparation brown, and destroying dissecting instruments. The strength employed should be :—persulphate of iron, 1 part; water, 10 parts. But this substance is very useful for coagulating the albumen-injections (§ 95) it having the property of causing a very abundant coagulum, containing a large quantity of water, while alcohol and acids make a flocculent precipitate. As it re-dissolves the coagulum if too strong,—persulphate of iron, 1 part, water, 100 parts—should be employed.

121. *Aqueous Solution of Corrosive Sublimate.*—This fluid possesses powerful antiseptic qualities, but it is objectionable for preparations on many accounts. It is neutralized by substances containing albumen, and destroys all metal instruments ; however, it is exceedingly useful for dry preparations. For this purpose—corrosive sublimate, 1 part, distilled water, 16 parts—which form a saturated solution, is injected into the vessels of the part, which should be dried quickly. A solution of the same salt, in the proportion of corrosive sublimate, 1 part, water, 50 parts, is used to moisten the interior of large hollow preparations. To prevent the attacks of insects, a certain quantity is poured into the cavity, and the object turned about, so that it may penetrate all the corners ; after it has remained in for some time, the preparation is drained and dried.

122. *Alcoholic Solution of Corrosive Sublimate.*—This is employed with great advantage to prevent the attacks of insects, &c., which would otherwise soon destroy dried preparations. The composition is—corrosive subli-

mate, 1 part; alcohol, 50 parts. The surface of the object (perfectly dry) is lightly brushed over with this liquid, which spreads rapidly, and penetrates all the fissures; the spirit evaporates quickly, and deposits enough of the salt to poison any insects that may attack the subject; at the same time, it does not soak into the preparation sufficiently to soften it.

123. *Aqueous Solution of Sulphate of Zinc.*—A saturated solution of sulphate of zinc, 14 parts, water, 10 parts—not only preserves the muscles, teguments, cerebral substance, &c., of Vertebrata without injuring the bones, but also does not become mouldy. It even preserves these substances in a natural condition, in the proportion of sulphate of zinc, 1 part, water, 10 parts; but it is then liable to mouldiness: this may be prevented by placing a little camphor on its surface. It hardens the cerebral substance, which facilitates its dissection, but it dissolves albumen, so as to cloud the liquid. It also possesses, according to M. Straus-Durckheim, the remarkable property of destroying all parts but the teguments of caterpillars, while the perfect insects are well preserved in it.

The larvæ of *B. Neustria*, which have the body tufted and brightly coloured, appear as if alive, although slightly distended, in this liquid, but naked larvæ become black. All parts, except the nerves of perfect insects, are well preserved in this fluid.

124. *Aqueous Solution of Sal Ammoniac* preserves the muscular substance of Mammalia, but destroys dissecting instruments rapidly. Muriate of ammonia, 1 part; distilled water, 10 parts.

125. *Aqueous Solution of Dried Chloride of Calcium.*—Chloride of Calcium (dried), 1 part, distilled water, 5 parts, with a little camphor, preserves the muscles of Mammalia pretty well, but oxydizes metallic instruments, and is too dear.

126. *Aqueous Solution of Nitrate of Potass.*—Nitrate of potass, 1 part; water, 10 parts, is occasionally used; it prevents putrefaction in muscles, but they become brown.

127. *Essential Oils.*—These, especially that of turpentine, preserve all parts very well, except the fatty portions, which they dissolve. They render many parts transparent (if previously dried), which is advantageous sometimes, as in injection of the lymphatics with mercury, but they are seldom used.

128. *Naptha*, used in the proportion of naptha, 1 part, water, 7 parts,—is said by Mr. Babington to form a good solution.

129. *Kreosote.*—26 drops, in a wine-glass full of distilled water, forming a saturated solution, preserves well, but renders the preparation brown.

MISCELLANEOUS FLUIDS.

130. ACID MENSTRUUM.—Acids are frequently required to dissolve the calcareous portions of animals, such as bone, shells, &c. The best are the following, as they leave no precipitate:—Hydrochloric acid, 1 part; water, 4 parts, by weight; or nitric acid in the same proportion.

131. ALKALINE LEYS. — These serve to convert

grease into soap, to render it capable of drying, and to make the preparation cleaner. They are :—

Weak Ley, composed of carbonate of soda (the soda of commerce), 4 parts; quick lime (in powder), 1 part; water, 100 parts. The mixture is to be stirred well several times during two or three days, and the carbonate of lime being allowed to deposit, the clear liquid is poured off for use.

Greasy bones, where the medulla oozes out, may be placed in this, and left from a week to a fortnight, and when they are seen to be sensibly less yellow (for they will never become quite white), they are to be boiled for a quarter of an hour in the same ley, to facilitate the combination of the grease with the soda. They must then be well washed in clean water, and dried. As this ley will at length attack the gelatine, the bones must not be left too long in it to whiten. To saponify spots of grease on the surface of preparations, little pieces of cotton, impregnated with this ley, may be placed on them.

132. *Strong Ley* only differs in the quantity of water, of which 50 parts are used instead of 100, as in the weak ley. It is injected into the cavities of bones, to saponify the remains of the medulla.

CHAPTER IV.

UPON THE PRESERVATION OF ANATOMICAL PREPARATIONS.

133. AFTER having so disposed of the different organs in dissection, that every part worthy of notice may be satisfactorily displayed, it is convenient to *preserve* such *preparations* for the purposes of reference or demonstration; and this may be done in two ways, either by drying, or else placing them in some antiseptic fluid.

The first method is generally employed for all solid parts, which do not lose their essential characters by dessication, such as bones, scales, horny substances, the testaceous crusts of articulated animals, the shells of Mollusca, and those of Zoophytes.

Membranous parts may be preserved dry, for seeing their form and position; and lastly, certain preparations of muscles also, but these become so much altered by the process, that their colour and relations are scarcely recognizable.

Dried parts unaffected by the air, but liable to the attacks of insects, as hairs, feathers, membranes, ligaments, and integuments, even when the latter have been tanned, require to be washed over either before or after dessication, with corrosive sublimate (¶ 122).

134. Solid parts which curl up much in drying, are commonly preserved wet; though they may also be preserved dry, when it is sufficient for seeing them in their natural state, to soak them in water some hours, when they swell out and assume their original form. This is the case with the white and yellow cartilages of the Vertebrata, those of the Cephalopoda, the gelatinous base of the bones, the calcareous part of which has been dissolved in acid; but not with the cartilage forming the base of the foetal bones, nor the membranes of the fins of fishes, which soften a little, but never swell out like the former. Soft organs, such as muscles, if wished to be kept in the dry state, should be impregnated with some embalming substance, to prevent decomposition, and protect them from insects.

135. Other soft organs, and muscles amongst others should always be preserved in fluid, being excluded therein from the action of the air, oxygen in particular favouring putrefaction, and from the sun, which blanches or otherwise destroys their colour.

When an anatomical specimen is not very thick, and is subdivided into several portions, the preserving fluid can easily penetrate throughout, whether the vessels are left open or filled with injection; but in entire animals, where, during warm weather, putrefaction might commence in the centre before the fluid had time to get there, it is necessary to make a small aperture in the thoracic and abdominal cavities, and inject some of it into their interior. Among articulated animals this precaution is seldom necessary, except in the large Crustacea, whose shell admits the passage of liquids

with difficulty from without. For other animals we must be guided by circumstances.

136. As preserving fluids, especially alcohol, are generally of an astringent quality, they should not be used too strong, as in that case they corrugate the organs; nor too weak, lest, by combining with the fluids from the animal bodies, their power of resisting putrefaction be lost. To avoid both these inconveniences, the liquid must be employed in the most suitable strength for preserving, and be changed at the end of fifteen days or a month.

PRESERVATIVE VESSELS.

137. Preparations are preserved in glass jars, from their transparency allowing all parts to be distinctly seen; those which are solid enough to support themselves are simply placed in the bottle, but others, which are too soft and delicate, require artificial supports. These may consist of plates of yellow wax, upon which the object is fastened with pins; but this method has two great disadvantages — that of the pins not adhering firmly to this substance, and the preparation so becoming easily detached and falling down, or oxydization occurring, and the verdegriis colouring and obscuring the liquid after some time.

M. Rousseau employs, instead of the above, small pieces of poplar wood, which is white and very soft, less expensive, more easily worked, and affording a more secure hold to the pins. For organs of a dark hue, the natural colour of these plates does well enough for

setting them off; but when white, as nerves and membranes, it is best to fix them on black plates, painted in oil, or with some black silk stretched over them.

138. Instead of brass or steel pins, M. Straus-Durckheim uses different kinds of vegetable spines, such as those of the *Cactus* and allied genera, or even fish bones, but as they are generally not very strong, holes should be made in the plate for their reception. Silver pins may also be used with advantage, from their solidity, but are very dear.

139. The preparations being very often specifically lighter than the fluid, especially when fixed upon the plates, they must be kept submerged by resting the latter against the lid, or else attaching lead or glass weights to certain parts of them.

Other preparations which are heavier than the fluid, would fall to the bottom unless supported, and for this purpose hollow balls of glass are employed which have a small hook beneath, to which the specimen is suspended and by which it floats, but simple cross pieces of wood fixed by a groove in the upper part of the jar are preferable, as being firmer and less expensive. Round discs of glass or wood with a cord passing through the centre may also be used. The jars containing the preparations should not be quite full, so that in case the liquid expands, the air may be compressed without their breaking; neither must the preparations themselves be exposed to the light, or if so, as in public collections, kept at least from the sun, which would give rise to a rapid elevation of the temperature of the liquid, and consequent bursting of the bottles.

140. As dissections must be often laid aside to be resumed at some other time, vessels are required for placing the preparations in. When the liquid in which the latter are immersed does not easily evaporate, a common trough will answer the purpose; but for alcohol, which soon loses its strength if the jar is not very well closed, round or square zinc boxes may be used, with the upper border rather wide and deep, and shut by a lid, the margin of which enters that of the box, so that a skin impregnated with oil and wax can be laid between the two, and the box be thus rendered air-tight.

For very small preparations, the best store jars are simply glass bottles with ground stoppers, in which they can be put ready fixed upon the plates, but as they are very dear, circular jars more or less deep, like dissecting basins, the apertures of which are closed by pieces of cork having the pores stopped up and soaked some time in melted wax, mixed with a tenth of olive oil, will be sufficient. Gallipots will also do, the edge of the lid being surrounded with a strip of leather steeped in melted wax, so as by its elasticity to close the jar. But the most convenient temporary covers are made of sheet caoutchouc, which must be warmed and stretched tightly over the vessel, and kept in place till cold by string; by this means, an elastic cover is formed, which retains its shape and is exactly adapted to the mouth of the jar.

141. It is not necessary for the specimen to be fully immersed in alcohol, as the vapour from a little of it at the bottom of the jar will preserve the specimen a long time.

142. BOTTLES, GLASS JARS, &c.—These are of dif-

ferent kinds and shapes, but generally cylindrical. Some have a deep circular neck, the rim of which is folded out horizontally. They are very useful, and met with everywhere in the shops. The best sort, however, are those with no neck, and the rim turned abruptly outwards into a very flat circle. In some, again, the aperture is funnel-shaped; but these have the disadvantage of the lid never sticking in properly.

As to those bottles with apertures narrower than the belly, the common ones, which shut by a cork, are to be preferred, for those with a glass stopper, though certainly the best, are too dear.

Flat, round, or long glass jars, must be used according to the form and thickness of the preparations. The very long jars should be provided below with a foot, to prevent their upsetting. For large anatomical specimens, square basins, formed of flat plates of glass, united at their angles by means of a cement (§145), which is not attacked by the liquids contained in them, are also used. But they should have their edges strengthened with a wooden or metal frame work, as this cement, without some such support, is hardly sufficient for keeping the sides together; the whole rests, and is let into a wooden stand. These troughs are very useful for receiving large preparations, for which round jars could not be used; but they possess the great disadvantage of being very expensive, and not allowing the objects to be seen through their sides, or even the top, the inner surface of which is covered with a multitude of liquid drops deposited by the vapours. Mr. Goadby completely fills the glass box, so as to get over this dif-

ficulty; but even in his method there is danger of the preparation being obscured, the salts of his preserving fluid depositing in a cloud on the glass.

143. LUTINGS AND STOPPERS. — Under this title are included the different methods employed for closing up the jars containing anatomical preparations. Small bottles with necks require merely to be stopped with a cork, which should be as little porous as possible, and may be steeped some days in poppy oil, so as to penetrate and fill up the pores; the larger holes can be stopped with putty.

Bladders are in constant use for tying over the mouths of jars. Sheet caoutchouc forms a very excellent substitute for closing jars containing other fluids than alcohol; where the preparation may be wanted out of the jar occasionally for examination, the Mackintoshed muslin is very convenient.

Lithocolle. — This cement is composed of *common resin, red ochre, oxyde of iron, yellow wax, and turpentine oil*, the proportions of which are varied according to the consistence required. The wax and resin are first melted, then the red ochre is added, and the whole having been stirred with a wooden spatula, and well boiled for a quarter of an hour, the oil of turpentine is poured in, and ebullition continued for 8 or 10 minutes. This operation should be performed in a vessel three or four times larger than the quantity of cement to be prepared, so that the latter may not catch fire, and with a handle, so that it may be easily removed. Common *Burgundy pitch*, to which a certain quantity of turpentine oil is added to give the mixture a better consistence, may also be used.

144. GLUES.—For fixing very small dried objects upon paper or plates of glass, the following different substances are used:—*White of Egg*, which does not, however, stick well to glass, and splits in drying. *Starch*; this has the disadvantages of not adhering to smooth animal textures, and of turning opaque. *Melted Sugar*, employed by M. Dujardin; and which consists of *sugar* of second quality (not perfectly refined), boiled till no longer crystallizable, and used afterwards dissolved in cold water; it is, however, difficult to prevent its crystallization or conversion into sugar-candy. *Gum Arabic*, dissolved in water, is particularly useful; it may be preserved in the state of mucilage for a long time; adding a few drops of any *essential oil* to prevent its getting sour. *Powdered gum* made into a mucilage with *distilled vinegar*, forms a very powerful cement; a little calomel added to this gives it greater consistence, when desirable.

145. MARINE GLUE is a substance lately invented, which is exceedingly useful in cementing together the glass basins (49-142), &c.; but it will not withstand the action of alcohol. It is made of *caoutchouc* and *shellac*, in the following manner, but may be obtained ready for use:—Dissolve 1 pound of *caoutchouc* in 4 gallons of *coal naphtha*; 1 pint of this solution is mixed with 2 pounds of *shellac*, which forms a substance, when cold, resembling sealing wax. It is applied, by making the parts to be joined very hot, then covering them with the cement, and pressing them tightly together till cold, when the superfluous portions may be cleaned off with *liquor potassæ*.

Part II.



THE MICROSCOPE.

CHAPTER I.

PRELIMINARY OBSERVATIONS ON THE OPTICAL PRINCIPLES CONNECTED WITH MICROSCOPES.

146. A DETAILED account of all the optical phenomena which have to be taken into account in the construction of an achromatic microscope, would scarcely come within the province of a work like the present; but as the relative advantages of the different kinds of instruments cannot be properly understood without an acquaintance with the optical principles on which they are founded, it has been thought advisable to give a brief summary of them here, in order to render this article as complete as possible. Those who wish for a more minute account, are referred to the excellent article on the microscope by Mr. Andrew Ross, in the Penny Cyclopædia.

147. It is presumed that the reader is acquainted with the property which transparent bodies possess, of refracting or bending out of the straight line the rays of light passing through them. It is on this property that the action of magnifying glasses depends. It is a known law of refraction, that rays of light passing from a *rare* into a *dense* medium are refracted in a direction perpendicular to the surface of that medium, and *vice*

versâ. This will be understood by referring to the diagram (fig. 20). A A are rays of light proceeding in

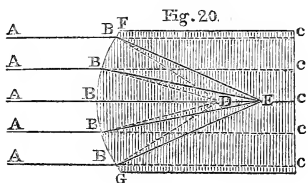

a direction parallel to each other, and impinging on the surface F B G. On entering the denser medium they are refracted towards the point D, the lines

B D being perpendicular to the surface F B G; but not being refracted quite to the perpendicular, they converge to the focus at E; B C the course of the rays if unrefracted. If the rays are allowed to re-enter the air by a plane surface, F G, the effect will not be much altered: this constitutes a plano-convex lens.

148. But if the rays re-enter the air by another convex surface they will be made to converge still more, as, in passing from a *dense* to a *rare* medium, they will be refracted *from* the perpendicular. Thus, in the

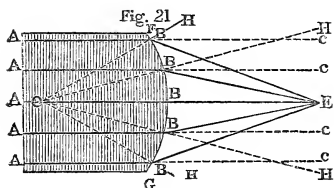
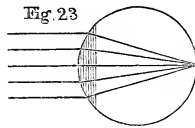
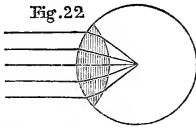

diagram (fig. 21) A B are rays of light passing in a parallel direction through glass, toward the convex surface F B G. B H are radii prolonged from

the centre O, perpendicular to the curved surface at the several points B B; and B E the course of the rays in consequence of being refracted *from* the perpendicular; B C the course of the rays if unrefracted.

149. Thus the effect of a second convex surface will

be exactly the same as that of the first, the opposite direction of their surfaces being counterbalanced by the different conditions of the refraction. Hence the focus or point of convergence of the rays, in a double convex lens, will be just half the length of that of a plano-convex; or, in other words, for parallel rays, the focus of a double convex lens will be the radius of its sphere



of curvature (fig. 22,) while that of a plano-convex will be its diameter (fig. 23).

150. Fig 22 also shows, that as a convex lens will bring parallel rays to a focus in the centre of the circle, it must cause rays diverging from that focus to take a parallel direction. Again, by the same law converging rays will be brought to a focus at a point near

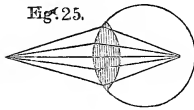
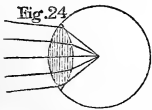

the convex surface fig. (24), while the focus for diverging rays will be more distant (fig.

25) than the focus for parallel rays; this latter point is called the principal focus. The converse of each of these positions of course holds good.

These principles are equally applicable to plano-convex lenses, always remembering that their principal focus is equal to the diameter, instead of the radius, of the sphere above referred to.

151. Concave lenses act in a manner exactly opposite to convex, their principal focus being termed the negative focus.

152. In the foregoing remarks we have treated the rays of light as if each pencil issued from a single luminous point, and that point coincident with the axis of the lens; now if this point be situated above the axis the focus will be below it, and *vice versa*, and every luminous body being regarded as comprehending an infinite number of such points, each radiating a pencil of rays, refracted in the manner already described, a perfect but inverted image of the said luminous body will be formed on any suitable surface placed in the focus to receive the rays.

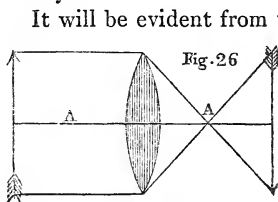

It will be evident from the diagram (fig. 26), which is founded on the proposition set forth in ¶ 149, that an object placed twice the distance of the principal focus, will give an image of the same size at the same distance on the other side of the lens.

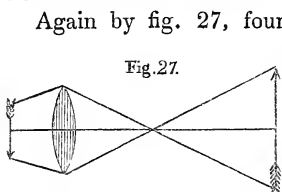

Again by fig. 27, founded on fig. 25, the object being further off the image will be nearer and larger, and *vice versa*. The larger the image in proportion to the object, the less light will be obtained, as only the same number of pencils of rays are concerned, these being spread over a larger surface.

153. These facts being understood, the action of simple magnifiers will be easily seen, but there are several imperfections which render their use very limited unless corrected, and it is to the perfection to which the correcting processes have been carried, that modern microscopes owe their great superiority. For the proper comprehension of the means by which this has been accomplished, some account of the nature of the imperfections will be necessary.

154. From the nature of the surface of an ordinary lens (a portion of a sphere), all the rays do not meet exactly in the foci above mentioned, this will be seen by fig. 28.

A B, a ray falling near the circumference of the lens will be brought to a focus at F, while (*a b*) rays falling near the centre do not converge to a

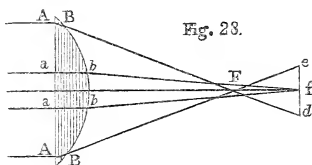

Fig. 28.

focus nearer than f ; thus we cannot get all the rays into focus at once, and an indistinct image is the result. This is what is termed *spherical aberration*. Lenses of other curvature than spherical have been proposed in order to get rid of this error, but the difficulties in the way of manufacturing such, caused the idea to be abandoned.

155. The way in which common simple lenses of high power are mounted, exhibits the usual method of attaining something like correction; this is done by placing a *diaphragm* or *stop* behind the lens, which cuts off the greater part of the peripheral rays, the *stop*

being a plate with a small circular aperture. By this means a certain amount of *defining* power is obtained, but it is only at the expense of *light* and *penetration*; that is, as the aperture is diminished the number of pencils of rays is proportionately reduced, and this reduction of their quantity prevents the surfaces of objects from being properly seen.

The single lens having the least spherical aberration is a double convex, having the radii as 1 to 6, with its most convex face turned toward parallel rays.

156. The next difficulty is the *chromatic dispersion*, as it is called, arising from the well known difference in the refrangibility of the various rays entering into the composition of common light. The fig. 29 will illustrate this.

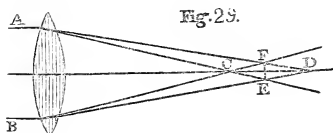

Parallel rays of light, A B, falling on a convex lens will be decomposed, as in the spectrum formed by a prism, but in a

less degree; the violet, the most refrangible rays being brought to a focus at C, somewhat nearer the lens than the principal focus, while the red rays on the other hand will have their focus D more distant; by the principal focus is here meant the mean focus, or focus of least aberration, which is at E E.

The contraction of the aperture of the lens is here again made use of, as the dispersion will evidently be greatest where the rays have their course most altered; but as this affords but partial correction, and that under very disadvantageous circumstances, other means have

been sought out, and fortunately for microscopic science have been found: these will be noticed hereafter.

157. By magnifying power is meant, not a power of increasing the size of an object, but of increasing the size of the image of that object formed upon the retina, which depends upon the size of the angle formed by the rays converging from the extremities of the object to the eye; in the diagram (fig. 30) this will be seen. A re-

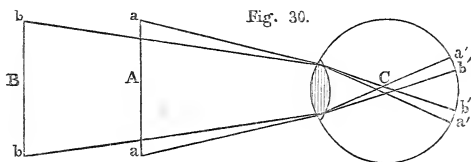

presents an object 10 inches from the eye; B one of equal size 20 inches distant; then, from the laws stated in the foregoing pages, we shall have the image $a' a'$ twice (or nearly so) as large as the image $b' b'$ on the retina, these images bearing the same proportion to each other as the angles $a a C$, $b b C$, which sublend the eye. These angles are what are called the angles of vision.

158. Now the same distance which determines the size of the angles of vision, also determines the size of the angles of the pencils of light, which give rise to the act of vision. By reversing the conditions of the former diagram, as in fig. 31, this is exemplified. $a a$ and $b b$ are two objects placed at the same relative distance as before; now it will be seen that the angle of the pencil of light derived

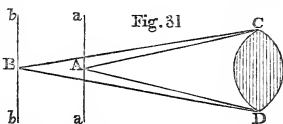

from A (and the same takes place with the pencils from all other parts of $a a$) will be double that proceeding from the point B, so that the object $a a$ will be seen by four times the light that $b b$ will, always supposing them to be equally illuminated. But then, as the area of its image is also increased four times (*see* fig. 30, it is there said to be twice, but that is by linear measurement for the sake of simplicity), that image will receive no increase of illumination from the increased angle.

159. These facts being admitted, the action of a single lens will be readily understood. The eye is formed in such a manner that it possesses very considerable power of adjustment, so that it can receive a distinct image from objects whose distances vary to a great extent; but there is a limit within which it does not possess this power, from the fact that it is constructed to receive parallel or slightly divergent rays; therefore, when objects approach very close, the rays are so divergent that it loses many of them, and consequently the image is undefined. The average distance of this limit is now generally stated to be 10 inches; we say the average, because in short-sighted persons it is frequently not more than 4 or 5, and in age sometimes as much as 30—depending as it does on the peculiar formation of the eye in each individual. Now when we place a convex lens between the eye and the object, this lens receives those divergent rays which would be otherwise lost, and refracts them so that they are conveyed to the retina, as is shown in fig. 32; the rays, after refraction, assume the direction of rays diverging from an object at 10 inches distance, C D, and are received

by the eye as such. The difference between the object at A B, and the imaginary one at C D, is called the

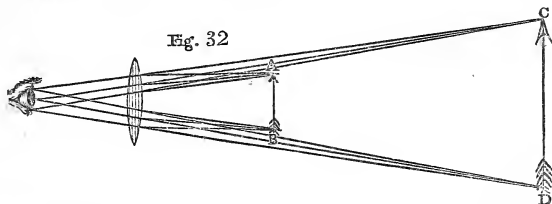

magnifying power, and evidently depends upon the focal length of the lens, the object A B being placed nearly in its principal focus.

The 10 inch standard has another advantage in practice, as a cipher added to the denomination of the fraction denoting the focal length of a lens, will give its magnifying power—a lens whose focal length is $\frac{1}{10}$ th of an inch, being said to magnify 100 diameters, or 10 times by linear measurement.

160. We have here another fact to consider. In fig. 31 was shown, that as an object was removed from the eye, the size of the pencils of light diminished; now something like the same circumstance takes place when an object is magnified; for, if we use an inch lens, we get an image ten times the size each way, at apparently ten times the distance, over which the pencils of light from the object have to be spread, consequently great want of light is experienced. Again, to allow all those rays shown in fig. 31 to pass through the lens would be incompatible with distinct vision, from chromatic and spherical aberration, so that here the stop or diaphragm would come into use, diminishing still more the

size of the angles of the pencils of light. It becomes necessary then to devise some means by which the aperture can be increased so as to give *penetration* without losing distinctness, or *definition*. The methods adopted for this purpose we shall next proceed to describe.

161. DR. WOLLASTON'S DOUBLET (fig. 33).—This consists of two plano-convex lenses, whose focal lengths have a proportion of about 1 to 3, the lens of shortest focus being placed next the object, and the convex surfaces of both directed towards the eye. A *stop* is placed between them.

Fig. 33



this combination will be best understood by the diagram, (fig. 34). P is a portion of the pupil, D D the diaphragm or stop, and L O L the object. It will be seen that the pencils of light issuing from the extremities (L L) of the object cross in the stop, so that they pass through the upper lens on the opposite side of the axis (P O) to that which they passed through in the lower one, and thus are affected by opposite errors, which to some extent neutralize one another. Thus, in the case of the pencil L, which enters the eye at R B, R B, this is bent to the right at the lower lens, and to the left at the upper, and as the blue rays (the most refrangible) are altered in their direction at *each* bending, and moreover, as the greater focal length of the second lens is compensated for by the blue rays falling nearer its margin where the refraction is greater than at its centre, the different coloured rays will emerge nearly parallel, and consequently colourless to the eye.

The fact of the ray which in one lens passes next the centre, passing next the margin in the other, also diminishes the spherical aberration.

This explanation, however, applies only to the pencils nearest to the extremities.

The central pencil will occupy the same relative position in both lenses, and, of course, the corrections will be imperfect; the intermediate

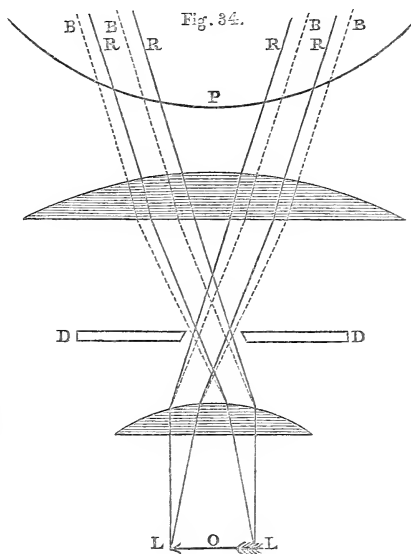

pencils will vary in degree between the two, so that there is always a great deal of aberration in the most perfect doublet. But these errors are trifling compared with those of a single lens, so that we can get an angle of aperture of from 35° to 45° , without sacrificing much *definition*. By the angle of aperture is meant the angle of the apex of the pencil of rays admitted by a lens.

162. The next improvement in the simple microscope,

was the triplet of Mr. Holland (fig 35), which differs from the doublet in having two lenses (placed close together) beneath the *stop*, instead of one. The first bend being accomplished by two lenses instead of one, the aberrations are diminished, so that the second bending

Fig. 35.



more completely balances them. Thus the triplet is really a doublet in its action, the first pair merely performing the same office (but more perfectly) as the lower lens in the Wollaston combination. The errors are still further reduced by the nearer approximation to the object which causes the refraction to take place near the axis. With the triplet, a pencil of 65° may be obtained, with distinctness, as also a more intense image.

163. The Coddington lens consist of a sphere, with a groove cut round it, filled with opaque matter. This gives a large field of view, which is equally good in all directions, as all the pencils must pass through under exactly the same circumstances, but its definition is not equal to that of an achromatic or even a good doublet, so that it is only employed as a hand lens, where much power is not required. It is the more adapted for this purpose from its spherical form, as the position it is held in, is of little consequence.

164. THE COMPOUND MICROSCOPE.—The simple microscope, as above shown, may consist of one, two, or three lenses, while the compound instrument must consist of two at least. In the triplet already mentioned, the two anterior lenses act merely as one, while the third only modifies the rays of light before they reach the eye.

But in the compound microscope the lenses act in a different manner ; the lower one receives the rays from an object, and forms an image of that object by bringing them to a new focus ; this image is treated as an original object by the second lens, and magnified by it as in the simple microscope.

Thus in fig. 36, the rays proceeding from the object $A B$ are acted upon by the lens $C D$, and brought to a focus at $B A$; not being intercepted here, they cross and proceed as from a new object, till they reach the lens $L M$, and are acted upon as in the simple microscope, and brought in nearly parallel lines to the eye at E . The rays $M E$, being part of the cone of rays $C A D$ issuing from the point A of the object, it is evident that the angle $L E M$, under which the eye will see the magnified image, must be much greater than the object could be made to occupy in the naked eye, at any distance within the limits of distinct vision.

The magnifying power of a compound microscope depends on two circumstances ; first, the ratio between the anterior distance $A C$, or $B D$, and the posterior focal length $C B$, or $D A$; secondly, the magnifying power of the eye-lens $L M$.

From the first of these two facts, it will be seen that a great variety of powers may be obtained with the same lenses, by increasing the ratio between the distance of

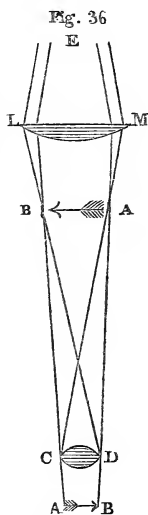

the object and the image, and from the second, that this ratio being fixed, any increase of power may be obtained by increasing that of the eye-glass. Moreover, by dividing the magnifying power between the two, in different relative proportions, almost any distance (within, certain limits, of course) may be obtained between the object and the object-glass. This constitutes one of the valuable peculiarities of the compound arrangement, and then there is the large *field* or angle of aperture that may be obtained, compared with a simple microscope, this *field* being nearly equally good all over, while that of the simple instrument is only good in the centre. The field is farther increased by using two lenses at the eye-end, forming together, what is called, the eye-piece.

But with all these advantages, the compound microscope was of little real use, owing to the great amount of chromatic and spherical aberration, until a few years ago.

165. Modern ingenuity and perseverance, however, have furnished science with what may almost be called a perfect instrument. A detailed account of the nature of the corrections in modern achromatic object-glasses, would take up too much space in the present work. A paper on the subject, by the discoverer, Mr. J. J. Lister, will be found in the transactions of the Royal Society for 1829: this paper is transcribed in Mr. Ross's article, in the Penny Cyclopædia.

By a skilful combination of double convex, and plano-concave leaves, made of glass of different densities, and cemented together, Mr. Lister succeeded in producing object-glasses, which had two foci in their axes on one

side, for rays proceeding from which they were truly corrected at a moderate aperture; beyond these two points, they are under-corrected—between them over-corrected.

The correction of chromatic aberration, as well as spherical, tends to excess in the marginal rays.

By over-correction for chromatic aberration, is meant, that the image formed by the blue rays is projected beyond that formed by the red, which is just the opposite of what occurs in a simple lens. The use of this will be seen, in the description of the action of the Huyghenean eye-piece.

166. The accompanying diagrams (figs. 37, 38) show the action of a compound achromatic microscope; the intermediate portion of the body is omitted for the sake of convenience. A A A are three achromatic lenses, forming the triple object-glass. FF the field-glass, and E E, the eye-glass, form the Huyghenean eye-piece.

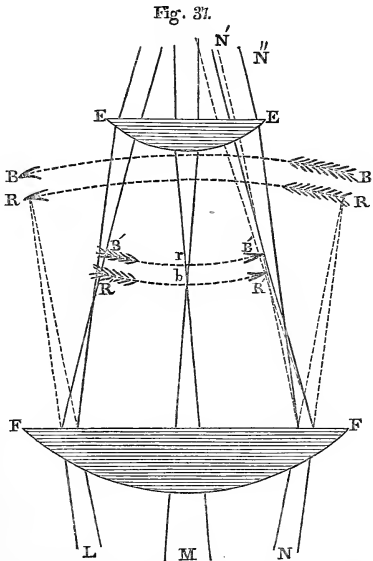
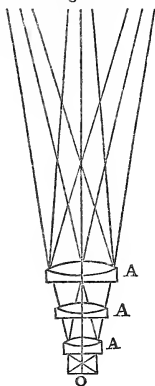

Fig. 38



Three rays drawn from the centre, and three from each end of the object O , show the course of the light. These rays, if left to themselves, would form an image somewhere between the dotted lines $B B$ and $R R$; but, being bent inwards by the field-glass $F F$, they form the image between $B' B'$ and $R' R'$, where a stop cuts off all light not required for the formation of the image; the eye-glass $E E$ then acts on the image, between $B' B'$ and $R' R'$, as a simple lens, converging the rays so that they may all reach the eye.

But this is not all that takes place. The object-glass being over-corrected (the purpose of which will be presently seen), the pencils of rays $L M N$ would form a series of coloured images, from $R R$ to $B B$. It will be seen, that the images here formed are curved in the wrong direction to be seen distinctly by a convex eye-lens, but the field-glass $F F$, while it converges them to $R' R'$ and $B' B'$, also reverses their curvature and gives them the form best adapted to the lens $E E$. The field-glass has, at the same time, brought the blue and red images closer together, so that they are adapted to pass uncoloured through the eye, the eye-lens altering them still more, so that they emerge from it in nearly parallel lines. This explanation will show why the object-glass is over-corrected. If the rays proceeding from it were achromatic, they would become coloured in passing

through the field-glass, and the blue rays would be brought to a focus at b , and the red at r , while the eye-lens requires the opposite effect, its blue focus being the shorter. But, by the over-correction as above shown, the blue rays BB , are projected beyond the red RR , just as much as the sum of the distances between the red and blue foci of the field and eye-glasses, and the separation $B'R'$ is exactly overcome in passing through those two lenses.

Again, the blue image is rendered smaller than the red by the field-glass, on account of the superior refrangibility of the blue rays.

In figure 37, in the pencil N , the whole lines proceeding from the field-lens represent the red rays, the dotted the blue. This separation, like the over-correction of the object-glass, leads to more perfect correction ultimately, for it causes the blue rays to fall so much nearer the centre of the eye-glass, that they are of course less refracted than at the margin; thus, the spherical error of the eye-glass almost perfectly balances the chromatic dispersion of the field-glass, and the rays $N'N''$ emerge nearly parallel. This holds good in all the intermediate colours and pencils.

167. When the magnified image is to be measured, the micrometer eye-piece of Mr. Ramsden is used. The arrangement of the glasses in this will be seen by the diagram (fig. 39). The rays from the object are made to converge at AA , in front of the field-glass, where is also placed a

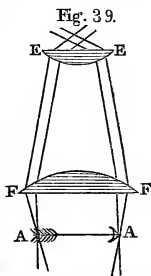

plate of glass with engraved divisions of $\frac{1}{100}$ th of an inch or less. These lines come into focus with the image of the object, so that they are seen together, and the measure of the magnified object is found at once.

CHAPTER II.

~~~~~

### MICROSCOPES AND THEIR APPARATUS.

~~~~~

SECT. I.—MECHANICAL CONSTRUCTION.

168. Not the least important part of a good microscope, as far as regards convenience to the operator, is the stand; but it would be impossible to notice here half the kinds that have been proposed, so that we shall be content with mentioning those essentials which all should possess, leaving out the details of arrangement. All the chief makers have some peculiarities in their instruments, each having its advantages, according to the purposes to which it is applied. The chief requisites appear to be:—1. *Steadiness*, as every vibration becomes a considerable inconvenience in using high powers; this is only to be gained by making the different parts of considerable strength, which must necessarily increase the weight; accordingly, if portability be an object, a

medium between these two must be found. 2. *Simplicity of arrangement* will be found of no little consequence by the microscopist, the multiplicity of parts causing considerable delay in getting the instrument into working order. 3. The motions for focal adjustments should in all cases be independent of the stage bearing the object; this is a most important consideration, and indeed is recognised as such by all the first makers. It is also exceedingly convenient to be able to give the body any degree of obliquity; the old upright microscopes were very disagreeable, and even injurious to the sight, on account of the uneasy position the operator was compelled to take.

169. Compound microscope stands now usually consist of a tripod with an upright pillar (sometimes two), having a hinge or cradle-joint at the top; this bears a bent bar carrying, below, the stage and mirror with the condensing apparatus, above, the body which rests in a great part of its length upon it, and has a rack and pinion movement.

170. In some, the pillar supports a block, bearing the stage, and having a stout tube fixed into it below, on which the mirror, &c. slide; through the block and tube plays a triangular bar, having a rack cut in it, worked by a pinion in the block. This bar has a horizontal arm fixed to it, into which the body screws. Here there will of course be great vibration, but the instrument is very much more portable than the other kind.

The fine adjustment is obtained at the lower end of the body, and its milled head being graduated, the thickness of objects can be measured by it.

171. In the best microscopes the stage is fitted with apparatus by which motion is obtained in all directions horizontally, by moving two milled heads; this, except for very high powers, may be looked upon as a *luxury*. The mirror should be large and capable of all kinds of motion.

172. CONDENSERS.—Between the stage and the mirror (or the illuminating body, if the mirror be not used) is applied the apparatus for condensing the light upon the object. This is constructed in various ways. The Wollaston condenser (fig. 40) consists of a tube

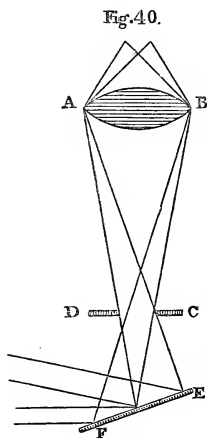

containing a double convex lens A B, at its upper end (capable of elevation or depression, within certain limits), and having a small aperture, C D, at the bottom. This fits below the stage and the light is reflected from the mirror, E F, up through the aperture, forming an image of it at the angles formed by the rays passing upwards from A B, which are supposed to coincide with the place where the object is situated; sometimes the object is best seen when these angles are beyond it, and sometimes when below it, their

adjustment for this is made by moving the lens A B. The achromatic object-glass next in power to the one in use, is now generally used instead of the lens A B, and produces a splendid illumination; to be perfect, a com-

ination exactly equal to the object-glass in use should be applied, but this would be very expensive, requiring a duplicate set of object glasses, which are the most costly parts of a microscope.

173. STOPS, or diaphragms below the stage, are often useful in cutting off extraneous light even when no condenser is used.

174. LIEBERKUHNS.—These are silver cups for reflecting the light, sent up from the mirror, or a lamp, on to opaque objects; they slide over the object glass, and produce a vertical illumination upon the object in their focus. For some purposes a side lens is better for condensing the light upon opaque objects, as it produces shadows which give an idea of the true form of elevated portions.

175. ILLUMINATION. — Light upon a white cloud opposite the sun, is the best daylight, an Argand lamp the best artificial; a large condenser or bulls-eye is useful in converging a greater number of rays on the mirror from the illuminating body.

176. MICROMETERS.—It has been already stated that 10 inches is taken as the standard of sight, in measuring the power of microscopes. For this purpose it is usual to place upon the stage a scale divided into certain known degrees (say $\frac{1}{100}$ ths of an inch), and when this is brought into focus, to hold a foot rule, divided into $\frac{1}{10}$ ths of an inch, at the distance of 10 inches from the disengaged eye, moving it horizontally, until one or more of its divisions correspond with a number of those on the magnified scale. A comparison of the two gives the magnifying power. This must be done with each object-glass.

To find the value of a micrometer it is necessary to apply the micrometer eye-piece with its graduated plate of glass, and to place upon the stage a scale whose value is known, observing how many divisions on the scale attached to the eye-piece correspond with one of those of the magnified image. If ten of these correspond to one, and the divisions on the two scales are equal, then the image is ten times larger than the object, and the object ten times smaller than is indicated by the micrometer. This proportion is constant for the same object-glass, so that, substituting an object for the divided scale, on the stage, the size is found at any time by mere inspection.

177. POLARIZING APPARATUS.—This consists of two crystals of Iceland spar, or single image prisms, as they are called; one of these is made to fit on above the eye-piece, and the other below the stage. These convert the microscope into a perfect polariscope, which is likely to become of great utility in the investigation of the crystals of the animal secretions.

178. FORCEPS.—A pair of forceps is commonly fitted by means of an universal joint to an arm, attachable at pleasure to the stand of the microscope: these are used to support opaque objects independently of the stage. The blades of the forceps made in this country are kept in contact by their own elasticity, and are separated by pressing on the heads of two pegs, each of which moves freely through the blade next its head, and is fixed to the other.

M. Straus-Durckheim has invented a much better arrangement, which will be understood by a reference to



the figure 41. The screw (G) is for the purpose of securely fixing the points (B E) together, when an object is held between them.

179. **BLACK STOPS.**—These are used to form a background to opaque objects held in the forceps. They are simply small blackened discs, supported on an arm attached to the stage.

180. **LIVE BOXES AND COMPRESSORS.**—Common live boxes are boxes of brass, made somewhat in the manner of a pill box, having a glass top and bottom: they are used either for retaining living air-breathing animals, or to hold water containing animalcules, &c. In the latter case, a small hole is drilled through the side of the cover, near the top, to allow air bubbles to escape, as it is pushed down. The best live boxes are made somewhat differently: the lower half is, as it were, turned bottom upwards, so that the glass plates can be brought in contact. The upper one of these latter should be of very thin glass. These live boxes may, with management, be made to answer all the purposes of the compressor, which is a nearly similar instrument, but is provided with an apparatus, by means of which the upper glass plate may be pushed down upon the lower by a delicate screw, and kept quite parallel with it during the action.

181. **CAMERA LUCIDA.**—This is made to fit over the eye piece of the microscope, and affords great facility for drawing microscopic objects, and may be so arranged as to act as a micrometer at the same time. The mode of using it will be given further on.

DISSECTING MICROSCOPES.

182. Little or no dissection can be performed beneath the compound microscope, from the distance of the object and consequent inconvenience of position. Under these circumstances, we have recourse to simple lenses or doublets; these may be fitted to the stands of those compound instruments which have the body supported on a cross arm (§ 170), or may have a separate stand of similar construction. The lenses should be so mounted that they may *drop* into a socket in the arm, not only for convenience, but as a measure of safety in using very high powers.

The stage must be large and strong, as it will have to sustain considerable weight when the hands rest on it, which, in use, they do; it should also be provided with the means of fixing the dissecting cell firmly.

Where very low powers only are used, a sufficient quantity of light is obtained to allow of the mirror or condenser being dispensed with. Under these circumstances almost any contrivance may be used to support the lens, and a regular instrument becomes unnecessary. A wire bent into a ring to receive the lens, and attached at the other end to a block of lead or a board, answers very well; but the apparatus about to be described is more convenient.

183. It consists (fig. 42) of a plate either of metal or wood loaded with lead, A, from which rises near one end a rod B; a ring slides on this, and has attached to it, by a hinge, the rod D. A second piece H, of the form shown in the figure rises from the front of the

plate; at the top of this is hinged on a ring, through which the rod D passes; at the end of D a short piece C, and another F, are fixed by vertical joints, and F terminates in a ring or socket G, which receives the lens. By pushing up the sliding piece on the rod B the lens is depressed, and vice versâ.

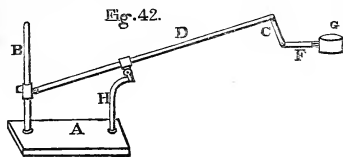

SECT. II.—ACCESSORY INSTRUMENTS.

184. PERHAPS the most frequently occurring operation in microscopical investigation, is the cutting of fine sections. For this purpose different processes are employed, according to the object.

For cartilaginous, horny, or similar structures, a razor, or scimitar-shaped scalpel, may be used; these also generally suffice for the more delicate tissues; but Prof. Valentin has proposed an instrument peculiarly adapted to these structures, which is here figured (fig. 43). This consists of two blades (A B), to one of which is fixed a handle (C); this blade is divided into two equal parts, the first portion (B F) is flat, and about $\frac{1}{25}$ th of an inch thick; the second (F A) has the form of a double edged scalpel,

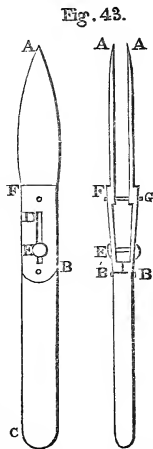

one of the surfaces being plane or a little concave, so that the edge may be sharper. Upon this blade rests the other, precisely similar, the pieces being in exact opposition by their flat surfaces; the second blade is moveable, and is attached to the first by a screw (B B'); and to prevent lateral motion, the first has a peg (F G), which passes freely through the second; they separate by their own elasticity, and are approximated by the slide (E) moving in the grooves at D. The distance between them having been adjusted to the required thickness of the section, the layers are cut off, remaining protected by the two blades, and may then be floated out in water.

185. Opticians use an instrument for cutting sections of the denser tissues, by which the substance is gradually pushed up (by means of a micrometer screw) through an orifice in a perfectly flat metal plate, on which a knife or razor glides; but where only one or two sections are required, such an apparatus only causes loss of time.

186. Fossil bones, teeth, &c. are cut by means of a steel disc and diamond powder on a lapidary's wheel; it will seldom be worth while for a student to undertake to do this for himself.

Fine saws and files are used for making sections of bone, which will require to be afterwards rubbed down upon a hone.

187. GLASS SLIPS.—Slips of crown glass, free from streaks or scratches, are commonly used for placing transparent objects upon; though plate glass is better, it is at the same time much more expensive. The most

convenient size is 3 inches long by 1 inch broad. Objects are covered with very thin glass, manufactured on purpose, which may be had of three different degrees of thickness, and is sold by weight.

188. GLASS CELLS.—The cells which have lately come into such general use, for objects which would be crushed by the covering glass pressing immediately upon them, are made in two ways:—the first is to cement a transverse section of stout glass tube to a glass slip; the second, which will be found the most economical, is, to make a sort of box upon the slip, by cementing narrow strips of glass to it. The process of cementing is the same in both cases, and is as follows:—For objects to be preserved in any aqueous solution, a small quantity of marine glue (§ 145), is placed on the slider, which is held over a lamp to liquify the cement; when it flows the piece of tube or strips of glass, as the case may be, having been warmed, are arranged on the slider and pressed tightly to it; the whole is then allowed to cool, and when the glue has set, the superfluous portion is removed by the application of liquor potassæ.

The covers, both for these cells, and for ordinary objects, are cut by a diamond, or what answers every purpose for thin glass, a crystal of quartz; for the cell-covers, a pattern must be drawn on a piece of paper and the thin glass placed over it, or a cardboard pattern may be placed upon it, and the cutting instrument run round it. In all cases care must be taken to lean as lightly as possible upon the glass, as the crack is very liable to run on from the cut already made, before the diamond has passed over the required line.

189. OPAQUE OBJECTS.—These may be either fas-

tened to plain glass slips, with a narrow ring of card to surround and protect them, or to discs punched out of thick leather, covered on one side with *dead* black paper; a pin passes transversely through the thickness of the leather, and serves both for the forceps of the microscope to hold by, and to fix the object in its case.

190. A dropping bottle is exceedingly useful, and is made by fixing a glass tube, drawn out to a capillary termination, into the cork of a small bottle; when this is reversed, the heat of the hand will expand the contained air, and drive out the water in very small quantities. Small glass rods and tubes are used for the same purpose.

Fine glass tubes are used also, for removing minute objects floating about in water, such as Infusoria. A modification of the pipette (§ 54), which consists of a small tube with a bulb, connected by another tube of caoutchouc to a mouth-piece, is very well adapted for the same purpose, as the point may be placed in water under a low power of the microscope, and objects be thus singled out and sucked up into the bulb.

191. RE-AGENTS, &c. It being frequently necessary in investigating minute structures, to apply certain tests to them, the working microscopist should be provided with these:—the chief of them are alcohol, turpentine, ether, nitric, sulphuric and acetic acids, tincture of iodine, and solutions of caustic potass (liquor potassæ), and of corrosive sublimate.

Test tubes will be necessary, where it is intended to submit the object to the action of these for a length of time, or at a high temperature;—glass rods are all that are required, in operating on the stage of the microscope.

CHAPTER III.

~~~~~  
MANIPULATION.  
~~~~~

SECT. I.—USE OF THE MICROSCOPE.

192. THE first question that has to be considered is, the purpose for which a magnifying instrument is to be used. If for the *dissection* of minute objects, where unassisted vision is not sufficient to guide the operator, the Simple Microscope is all that is required ; but if for the investigation of the structure of tissues, &c., then the Compound Microscope will be necessary.

193. THE SIMPLE OR DISSECTING MICROSCOPE.—This should be furnished with lenses of various powers, the lowest of about $1\frac{1}{2}$ inch focus ; for the higher powers doublets are advantageously made use of, as they afford a much larger *field* than a simple lens ; a focus of $\frac{1}{10}$ th of an inch will be about the highest that can be advantageously used.

When dissecting under the microscope, the elbows should rest upon the table, and the hands should be supported and steadied by the large and strong stage (¶ 182). If the object be immersed in water, the stage will have to remain in its horizontal position ; and, indeed, this will almost always be necessary with the

simple microscope—whence arises great inconvenience, from the constrained position the observer is obliged to take.

With shallow powers, no apparatus for increasing the illumination will be necessary; but with deeper, a condenser for opaque objects, and a reflecting mirror for transparent, will be necessary. If the object is very small, it is best dissected on a slip of glass, or in a cell (§ 188); otherwise a cork plate (§ 50), which may, if desired, be kept under water in a glass trough (§ 49), is the best, as the dissected portions may be spread out, and kept in place by fine pins. The instruments used will be the needles (§ 76) and the microtome (§ 72).

Investigations with high powers in the simple microscope, should not be long persisted in at one time, as the straining of the eye, and fatigue of a continued uneasy position, cannot but be injurious.

194. THE COMPOUND MICROSCOPE.—As all the necessary apparatus has been described in a former chapter, it only remains here to point out the most advantageous manner of using it.

The microscope should be placed on a firm and steady table, and if by day, a position must be chosen, where it will not be exposed to the direct rays of the sun, as they would interfere seriously with the proper illumination of the object, causing an iridescence, or fringe of prismatic colours around all parts. At night an Argand lamp is the best illumination, and it should be provided with a paper shade, as the opaque shades cause too great a contrast between the light of the field of the microscope and the obscurity of the room. This contrast is

indeed advantageous as far as seeing the object clearly is concerned, but it is very injurious to the eyes.

195. The eye-piece and object-glass having been fitted on, and the instrument inclined so as to allow the operator to take an easy position, the mirror is then to be adjusted. The easiest way to bring the pencil of rays opposite the axis of the instrument, is to look at the object-glass from below and move the mirror until the light is reflected upon the lens, then looking through the eye-piece a very little more adjustment will give the illumination. As a rule it is well to begin the examination of any object with a lower power, and this for several reasons; if the low power proves sufficient to make out the point of investigation, all the advantages of a larger field, greater clearness, and brilliancy of the object are gained, and if the power be not sufficient, a kind of general view of the object is obtained, which will allow the relations of parts to be better understood when seen by higher powers.

196. TRANSPARENT OBJECTS. — If the object be transparent it should be placed on a slip of glass (§ 187), and a drop of water having been added, it should be covered with a piece of thin glass. It is then placed upon the stage in such a manner that the object may be as nearly in the axis of the instrument as possible; by the large milled head it is brought into focus, and even if the object itself is not opposite the object-glass, the focal distance will be perceived by the extraneous matters on the glass slip becoming visible. In this latter case the glass slip must be moved about with the fingers, or if on an adjusting stage, by means of the milled heads upon

it. The exact focus, or the foci of different parts of the object are best obtained by the fine adjustment on the body, and by the same means an idea is obtained of the relative position of these parts ; for instance, in viewing a spiral fibre, as in the *tracheæ* of insects, one side of the spiral is brought into focus, and then by gently turning the head of the fine adjustment the turns of the spiral are traced round to the other side. The fine adjustment being graduated, also serves to measure the depths of depressions, &c. ; in the same manner the plane surface of an object is brought into focus, then the bottom of the depression, and the difference is seen by means of the index on the fine adjustment.

If the power first made use of be not high enough, the next above it should be applied, and so on in succession, if necessary ; with the higher powers, the condenser (§ 172) comes into operation ; for, as the magnifying power is increased, the light is diminished (§ 158), and, it is therefore needful to condense a greater quantity of light upon the object. The best condensers are made to adjust, both for the focal distance and lateral movement, by means of milled heads, and this lateral motion is occasionally of service, in discovering the true structure of certain tissues. An increase of defining power, though the light is diminished in quantity, is obtained by the diaphragms, or stops (§ 173) ; these are especially useful in viewing very transparent objects.

When a low power is used, especially in the day-time, it is a good plan to place a shade of blackened card on the stage, between the light and the object, as the direct rays, falling upon the surface of the latter, interfere with

those passing through it, and cause a certain amount of indistinctness.

The live-boxes (§ 180), and cells (§ 188), come into use when the object is of appreciable thickness, and when pressure is to be avoided; these must be completely filled with water, all air-bubbles being carefully excluded. It is important in all cases, with transparent objects, to avoid getting air-bubbles among the parts of an object, not but that they are soon known, and then easily distinguished, but they cause a disturbance of the direction of the rays of light passing through or around them, which distorts the portions of the object in their neighbourhood.

Occasionally, direct pressure, or a sliding motion between the glass slip and its cover, are useful; as for expelling the contents of delicate tubular structures, &c.

Re-agents (§ 191) are applied to objects under the microscope, by means of a fine glass rod, which is dipped into the liquid, and then applied to the margin of the thin glass covering the preparation; the capillary attraction soon brings it to act upon it, and it is well to use the re-agent in a very diluted state, as, by that means, a slower action is obtained, which may be traced as it gradually extends across the field.

Certain objects, such as living insects, &c., may be viewed by transmitted light while held in the forceps; in this way, the circulation may be seen in the legs of some of the Arachnida, &c.

197. OPAQUE OBJECTS.—These are generally viewed with the lower powers, in fact Lieberkuhns (§ 174) cannot be used with the higher. They are illuminated

either vertically by the light sent up from the mirror, and condensed upon them by the Lieberkuhn, which slides over the object-glass ; or laterally, by a condensing lens placed between them and the direct light. If they are mounted on the discs (§ 189), they merely require to be held in the forceps, which fit into a hole on the stage ; but if they are on glass slips (§ 189), or are loose objects, such as insects, &c., held in the forceps, the black stop (§ 179), must be fitted on, so as to form a dark back ground for them. Those held in the forceps, whether on discs or otherwise, may be moved in every direction to see the different parts, and it is the easiest plan to get these pretty nearly into focus in the first instance, by moving the forceps.

198. CAMERA LUCIDA (§ 181).—In using the camera lucida, the most convenient position for the body of the microscope will be the horizontal. When the apparatus has been fitted on at the eye-end of the body, a piece of paper must be placed exactly beneath it, of a size proportioned to the object to be drawn, and at the distance of distinct vision, which will vary in different persons ; if the observer be very short-sighted, it will be necessary for him to wear spectacles.

The camera lucida should be turned up at first, so as to enable the observer to get the object into focus, and to pick out those portions intended to be drawn ; on turning down the apparatus, it will be found that the focus is a little altered by it, but that is easily adjusted, and then the image will be seen distinctly projected upon the paper placed beneath. The size of the image may be increased, by removing the paper to a greater

distance, but this enlargement injures the clearness and distinctness of it. With a finely pointed pencil the outlines of the image are to be traced on the paper, which, after a little practice, will not be found difficult, especially if the following precautions be taken :—It is essential to the perfection of the image, that the paper and the object be equally illuminated, and this will easily be accomplished. The brightest light will usually be upon the object, so by placing a taper beside the paper, the light upon that will be increased ; if, on the other hand, the object is rather dark, and more light cannot be obtained for it, a screen should be interposed between the paper and the lamp. This condition must be attended to, as if the object is brighter than the paper, the point of the pencil will not be seen ; while, if the paper be too bright and white, the image will be so dim, that a faithful representation can scarcely be made.

The eye must be kept as steady as possible, as the least movement alters the place of the image on the paper ; the position of the eye, also, has an influence on the distinctness of the image—but this must be found by experience.

If the object be large, probably the paper will have to be moved during the operation. It will require some few days' practice to get a facility in all these little manipulations ; but when once acquired they will be found comparatively easy.

The camera lucida affords a very convenient method of measuring objects. A micrometer scale of known value is placed upon the stage, and the magnified images of the lines on it, drawn on the paper. These lines may

then be subdivided to almost any extent, and thus a scale will be obtained, by which images drawn under the same power, and at the same distance beneath the camera, may be measured.

199. The measurement of objects has already been alluded to (§ 176) ; but if no very accurate measurement be required, and the power of the object-glass be known, a near approach to the size may be found by holding the foot scale (§ 176) at a distance of 10 inches from the eye, and comparing the image with it. This will be found easy after a little practice, as, from the natural *single vision* of the two eyes, objects seen separately by them become as it were blended together.



SECT. II.—PREPARATION AND PRESERVATION OF OBJECTS.

200. IN the investigation of the softer animal tissues, it is obvious that the greatest care and patience are requisite, not only on account of the minuteness of their ultimate structure, but its delicacy, and the false results that are likely to be obtained from the examination of portions which have been much subjected to the action of foreign agents. These structures should be examined as much as possible in a perfectly normal state, and if maceration, boiling, or the action of re-agents be had recourse to, as matters of convenience in following out particular views, still the appearances should be carefully studied, both with and without these processes, so as to arrive at a correct estimate of their value. It is

probable that the absence of such precautions has caused much of the discrepancy in the ideas of microscopists as to the nature of many of the tissues.

201. Structures to be examined in a normal state should be taken from the bodies of very recently killed animals, being removed in minute portions, with as little violence as possible, and placed by means of fine needles (§ 76) in a convenient position for examination upon a slip of glass; the object should then be covered with a piece of thin glass, without pressure, and placed on the stage of the microscope. All the delicacies of manipulation, with regard to the getting of different parts into focus, and the play of light by means of the condenser, should then be put into operation. The agency of boiling water which dissolves gelatinous matters, and alcohol, and the acids, &c., which coagulate fibrine, may afterwards be had recourse to, and in this manner the observer will be able to satisfy himself of the nature of the object. But the young microscopist must not imagine that these short directions will enable him at once to arrive at a correct knowledge of intimate structures; so many delicacies of manipulation, so much of that uncertainty of obtaining favourable views of the object, which is inevitable in operating on such minute portions, and so many deceptive appearances, stand in his way, that it is only after repeated observations and considerable practice, that he must begin to draw conclusions from what he sees.

202. When the denser tissues, such as horn, &c., have to be examined, it will be necessary to make extremely thin sections of them, and this, after a little

practice, will not be found very difficult. It is a good plan to have a sort of pad of cork to rest the object on, as this affords a steady but somewhat yielding support, which will be found advantageous, while its softness prevents injury to the cutting instrument. Sections should be made in various directions, in order to ascertain all the peculiarities of the structure; and here again the observations contained in the last paragraph will be applicable. Where the object is not sufficiently transparent it may be enclosed in Canada balsam, the method of doing which will be indicated below (§ 213).

203. Blood corpuscles may be kept in suspension in serum, or a weak solution of salt, while under examination, as pure water causes them to change their form and burst; the various re-agents here also will be useful in investigation; other fluids are merely kept between two pieces of glass, or if they contain crystallizable matters, may be suffered to evaporate on a slider, and examined with the polarizing apparatus.

204. Osseous structures are examined in thin sections, made either by the lapidary, or by means of a fine file, &c., (§ 186); they should be moistened with water to render them more transparent, or if to be kept, mounted in Canada balsam.

205. The internal organs of the transparent aquatic animals, such as Infusoria, may be rendered more apparent by feeding them with a colouring matter, which will not poison them, such as indigo or carmine, the colour may be rubbed with water from a cake, and a small quantity of it added to the fluid containing the animalcules; they soon swallow enough of the particles to

render the alimentary canals very apparent through the parietes. These creatures are most conveniently singled out with a hand magnifier, and are then captured by means of the pipette (§ 190), or a fine glass tube. The siliceous loricæ of the fossil species should be mounted in balsam.

206. Some bodies, from the peculiarities of their form, influence the light passing through them in such a manner, that they cannot be well seen until they are enclosed in some medium denser than air; among these are hairs, the fibres of sponges, &c., which must be mounted in balsam, and this besides, increases their transparency, so that their internal structure is better seen. The siliceous spiculæ of sponges are obtained isolated, by burning away the animal matter before a blowpipe, and treating the residue with nitric acid, which dissolves off all but the spiculæ.

207. Little need be said here with respect to opaque objects, as the methods of viewing them have been already pointed out (§ 197), and as they mostly consist of the external portions of the smaller animals, the processes of preparing them for examination are little more than the dissections, which will be treated of in the Third Part of this work.

208. It may be repeated here, that full directions for all the manipulations necessary in bringing the microscope to act with the greatest advantage, in all cases, and upon all kinds of objects, are not attempted to be given here; if there were no other difficulties, space would not allow of it; but it has been endeavoured to point out all the most important of them in such a

plain and concise manner that the beginner (and the writer does not presume to instruct others) may see his way clearly, and be enabled to take such measures as will, at least, put him in the right road to success. Various modifications of the processes here given, will of course suggest themselves to him as he becomes more practised, and by the time such skill has been acquired, an elementary treatise like the present, will have been laid aside.

PRESERVATION.

209. Transparent preparations which may be kept dry, are placed upon a slip of glass (§ 187), and covered with a small piece of thin glass proportioned to their size, which is kept in its place by pasting over the whole a piece of paper, through which a hole has been punched corresponding with the situation of the object; should the object be of some thickness, and pressure be undesirable, a piece of cardboard of proportionate thickness, with a hole punched through it, must be placed between the two pieces of glass. This method of mounting is little resorted to, being only adapted to a few objects, the transparent wings of insects, &c.

210. Transparent objects to be kept wet for the sake of transparency, and for the prevention of decomposition, are mounted in several ways. A very thin object, where a little pressure will do no harm, is placed on a slider, and a drop or two of the preservative solution (§ 113-14, 129) added; a piece of thin glass is then laid over it, and if the fluid be pressed out round, it must be wiped quite dry by means of a camel-hair pencil; if the fluid

does not completely fill the space between the glasses, more must be added, which will be imbibed on account of the capillarity.

All pressure upon the thin glass must be avoided, as it would press out the fluid, which, when the pressure was removed, would allow air to rush in; all bubbles of air also must be carefully excluded, when placing the thin glass upon the object. These two glasses are then converted into a cell, and this is done by varnishing the edges of the thin glass, and the contiguous portion of the slider with gold size, a layer of which, extending from one to the other, encloses the preserving fluid.

The gold size should be previously thickened to about the consistence of treacle, by rubbing down a little lamp-black in it; the lamp-black should be quite dry, which may be conveniently ensured, by heating it in the bowl of a tobacco-pipe. Several successive coats of this varnish should be given, allowing each to dry; and for laying on these a sable pencil is the best instrument, as softer hair soon loses its elasticity and becomes useless.

211. The cells (¶ 188), which should be cemented together with gold-size where dilute alcohol is used, are suited to objects like those mentioned in the last paragraph, but in which pressure is to be avoided. They are to be completely filled with the fluid, to the exclusion of all air-bubbles, when the cover, which should be neatly fitted, is put on; they are closed with the gold-size in the manner already described.

All preparations preserved in this way, especially in

the modification of the cell described in the preceding paragraph, should be looked to occasionally, as, in spite of every precaution, the air will sometimes get in; it would perhaps be well to lay on a fresh coat of size from time to time.

212. Another modification of the cell has been long in use, made by laying several coats of white lead on a slider, leaving a central clear space; when the cell is deep enough, the object and fluid are placed in the central space, and the thin glass put on, which adheres to the recent coat of white lead. This method is seldom adopted, from its requiring so much preparation. Another plan is to place thin objects between two sliders of equal size; these are tied together at each end, and the whole kept in a jar or bottle containing a little dilute alcohol.

213. The method of mounting objects in Canada balsam, affords the means of obtaining the most beautiful, and at the same time the most permanent preparations, but requires rather more delicacy of manipulation than either of the foregoing. It is well, if possible, as pointed out by Mr. Varley, to keep the objects for some days previous to mounting in oil of turpentine, as, besides ensuring their transparency, it lessens the risk of air-bubbles, on account of its penetrating the cavities. At all events small animals, such as Acari, should always be placed in it for a short time previous to placing them in the balsam, as the hairs, &c., on their bodies are otherwise almost certain to entangle a portion of air; in endeavouring to press out this between the glasses, the

animal's body will be burst, which will of course much disfigure the preparation.

A drop of balsam proportioned to the size of the object is to be placed on a slider, and gently heated to liquify; the object is then laid upon it, and its immersion assisted by means of a fine needle, also slightly heated, to prevent the balsam from adhering to it. A piece of thin glass is then warmed and carefully pressed down upon the drop of balsam, which is thus impelled into the cavities of the object, while the air is driven out all round. Too great a heat must not be applied, as it causes ebullition in the balsam, and quickly hardens it into a sort of resin; but if the object be pretty tough, and there be a sufficient quantity of balsam on the slider, the whole may be heated a second time, after it has set, to drive out bubbles.

The previous soaking in turpentine may be dispensed with in some cases, as in mounting crystals for polarization, or the loricae of Infusoria, &c.; in these cases, a considerable quantity of balsam should be used, so that the upper glass may be pressed down with greater force to drive out bubbles; but this is apt to spread small isolated objects, such as loricae, &c., too much over the slider, which may be avoided in some measure by placing them in a little heap on the balsam, in the first instance.

The most convenient way to heat the glasses is, in the winter time, to place them on the hob of a stove, otherwise a spirit lamp should be used. The balsam which exudes round the edges of the thin glass, may be

neatly trimmed off when cold, and the name written with a diamond on the slider, or the whole may be covered with paper, as in ¶ 209, and the name written upon it.

214. Opaque objects are fastened with gum or isinglass upon the discs (¶ 189), or glass slips (¶ 189), already described.

Part III.



DISSECTION & PRESERVATION.



CHAPTER I.

INTRODUCTORY REMARKS.

215. HAVING in the preceding parts of this work, treated of the various contrivances which may be employed in the study of Comparative Anatomy and the methods of using them, our next step will be to apply that knowledge *practically*, or to the *dissection* of Animal Structures. Before, however, entering into any of the details of this operation, as it is varied to suit the kind of objects under investigation, a few preliminary observations are necessary, relative to the order in which it should be conducted, the selection of specimens, &c.

In dissecting the higher animals, those which in their general organization approach the nearest to that of Man, as the Vertebrata, the use of the scalpel is with but few exceptions admissible. In the Invertebrate series, on the contrary, from their small size, and the delicacy of their different parts, the dissection mostly consists, after having opened the body, which must be done under water, in unravelling and displacing them from their slight connections by means of fine needles. In all animals, however, of sufficient size to admit of being regularly dissected, the course to be pursued is essentially the same. Parts are to be dissected by proceeding from

without, inwards and studying each in succession as they severally occur, except where it is wished to gain a general idea of the position of many of them by making sections, or where it is intended to examine some particular organ only, without reference to the rest.

216. To illustrate this, the body of a vertebrated animal, as being the most complex in its organization, may be taken for an example.

After the outward form of the animal has been well studied, and contrasted, when possible, with that of allied genera and species, attention being also paid to all those elevations or depressions of the surface which indicate the position of muscles, vessels, or other important organs, the dissection is to be commenced by raising the *integument*, and immediately beneath it there will be found in most situations a quantity of loose *cellular* and *adipose* tissue, especially abundant in the flexures of joints, and which, as forming a continuous investment over the whole body, should be carefully traced to see how and in what different directions it is prolonged. When this has been removed, the fibrous membranes or *fasciæ* will be seen, forming expansions of considerable extent over certain parts, as the limbs and abdomen, and by raising these the *muscles* are next exposed, contained in sheaths of a cellular or fibrous tissue. Along with the dissection of the muscles, the course, relation, and distribution of the principal *arteries*, *veins*, *lymphatics* and *nerves*, accompanying them, will be learnt; and these having been well dissected, some upon one, others upon the opposite, side of the body, the visceral cavities may be opened, and their contents, such as the *respiratory*,

digestive, and *generative* organs, as well as the *central* portions of the *circulatory* and *absorbent* systems be examined. It is best to defer the preparation of the *bones* and *ligaments* until the last, as they are composed of less perishable materials than the other structures, many of which, namely, the *brain* and *spinal cord*, with the more complicated *organs of sense*, as the *eye*, *ear*, and *tongue*, require in most cases a special dissection upon a very fresh subject (where that can be had), without regard to the sacrificing of other parts. It is needless to say more here upon this subject, as particular directions are given in the following chapters upon the methods of dissecting the different systems of organs, throughout each division of the Animal Kingdom.

217. For the purpose of dissection, subjects should be selected, as much as possible, in a normal condition, provided that no special object to the contrary be held in view. They ought to be rather lean than fat, but not so morbidly thin that the organs are atrophied. A small quantity of fat is of advantage in a number of cases, from being generally placed in the intervals of organs, which it serves to render more apparent, either by separating them or causing their colours to stand out upon the white ground that it presents.

218. Animals ought also to have died without experiencing severe wounds or bruises, as these always destroy some of the organs. When they are made to perish by a violent death, it is a good plan to effect this by prussic acid, but as this fluid is very dangerous to meddle with, recourse should be had to other means, and death by hemorrhage or drowning is the best, from the rapidity

with which the animals die without injury to themselves.

219. When the body of a vertebrated animal is not intended for injection, it is a good plan to let it become quite cold before opening it, so that the blood may become well coagulated, and not liable to trickle out upon opening any of the vessels, so as to soil and discolour the different organs, which would prove a source of much embarrassment to the dissector.

220. If there is no particular reason for preserving the integument of an animal entire, it should be merely removed piece-meal, and so much only as is necessary at a time, leaving the other parts covered with this envelope, which best preserves them fresh, with their suppleness and natural colours.

As to hairs and feathers they can be removed, if it is not too much trouble, since they are only in the way, but it is clear that their bases must be left attached to the skin, if their mode of insertion is to be studied.

221. If the carcass is rather bulky, as that of a *hare* or *fowl*, and the intestines cannot be removed at once, a very small incision (by a trocar and syringe) should be made in some convenient part of the abdomen, and a certain quantity of preserving fluid injected into the abdominal cavity, to prevent the too rapid putrefaction of the viscera, which is especially liable to occur from the fecal matter contained within the intestines.

222. As animals of large size cannot be placed in jars of preservative fluid, some of it may be injected into the large veins, or into the trachea in birds, and will

be sufficient to retard putrefaction until the dissection is completed.

Small animals may be generally preserved entire in fluid without the above precautions; yet if the integument is very hard or impermeable to the fluid, it is advisable to inject some of it into the abdominal cavity.

223. When it is wished to make the *skeleton* of a vertebrated animal, a subject should be chosen of adult age, or a little older and at a period of life when the epiphyses are not completely united and still distinct. If on the contrary, the epiphyses are wanted separate, individuals are preferable which have arrived at about two-thirds of their full growth. No determinate period can however be fixed in this respect for all animals, as it varies very considerably; thus in birds, the bones of the head unite at a very early age, so that a very young subject must be had for detaching them. Of the osseous nodules which enter into the composition of the different bones, some unite before, others at very variable periods after birth; lastly, among fishes most of the ossific centres produce pieces which remain distinct during their whole life, and hence it is that these animals have so complex a skeleton.

224. For the study of the *ligaments*, it is best to take a rather aged individual, these organs being then generally better developed, stronger, and more distinct than in young subjects, especially the *aponeuroses*, which in the latter are almost entirely cellular.

225. The *muscles* are most distinct in middle age, when the animal is healthy, vigorous and active. The subject should not be too fat, though a small quantity of

the latter is of advantage, for the reasons already stated. Animals which have been killed in the chase after a long run, have the muscles usually of a deeper colour than those which have remained inactive, and their tendinous insertions can be more clearly distinguished. The same characters are to be remarked in agile, as contrasted with slow-moving species,—in the wild animal, with one bred up in captivity, where it often happens that, with age, the muscles, from want of exercise, have become blended together, particularly in certain parts, as upon the vertebral column, where motion is very limited. Thus, if it is wished to study the muscles in a general manner, as throughout some class of animals, preparatory to appreciating their specific differences, those creatures should be selected whose movements are most frequent and rapid—and Man in this respect is not the most advantageous subject.

226. Subjects designed for the study of *splanchnology*, ought to be healthy and slightly fat; for in such individuals as are too thin, the coats of the intestines, the masses of glands, every part indeed is flabby and as if atrophied, especially if the leanness be the result of disease.

227. For *angeiotomy* and *neurotomy*, the subjects ought to be thin, so that without being in a state of marasmus, there is no fat to obscure the vessels and nerves. In human anatomy, lymphatic and nervous females are preferred, as in them these organs are easily detached.

As to the inferior animals, *e. g.*, the Articulata, Mollusca, and Radiata, having very often no choice, such

must necessarily be taken as come to hand. In case, however, there is a great number of specimens at our disposal, the finest of course are to be selected.

228. Next in importance to the dissection of an animal, it is indispensable for the student of comparative anatomy to acquire the art of *describing* with accuracy, perspicuity and distinctness, the various objects which his scalpel has disclosed ; a faculty, indeed, by no means attainable at first, and which can be gained only by practice and a strict observance of the meaning of the terms used in scientific language. It is almost needless to insist upon *drawing*, as most useful in aiding our actual researches, and the pen.

229. Lastly, in preparing to investigate any point in comparative anatomy and physiology, if with a view towards publishing the results of his labours, the observer should never neglect to make himself acquainted with all that has already been done (if any) upon the subject, both by the old and recent authors of this country and the continent. In this way much useless pains, and subsequent disappointment as regards originality, will be frequently avoided.

CHAPTER II.

~~~~~  
TEGUMENTARY SYSTEM.  
~~~~~SECT. I.—*VERTEBRATA*.—MAMMALIA.

230. DISSECTION.—To make preparations of the integument, it is detached in moderate sized strips, which are to be submitted to the microscope; for it is only with the assistance of this instrument that its texture, and the structure of the minute organs enclosed within the corium, can be recognized.

The *epidermis* may be removed separately by different methods, of which one of the simplest and quickest consists in plunging the skin into water, nearly boiling, but not in a state of ebullition; for at this temperature the fluid not only renders the epidermis tough, but dissolves the rete mucosum, which, as well as a part of the dermis, is composed of gelatine. The above separation is obtained also by maceration in water; but the fitting time must be then seized upon, when the epidermis begins to detach itself, to secure it before being decomposed.

The intimate structure of the epidermis, thus detached from subjacent parts, can be easily studied by examining it under water, so that it may not dry up; a

process which has moreover the advantage of detaching and floating out the minutest particles, which could not be perceived out of the fluid, when they all adhere together.

231. In removing the epidermis great care must be taken, in order to see the cæcal prolongations sent by it into the small cavities, such as the sebaceous crypts, the bulbs of the hairs, &c., to line them. The better to distinguish these prolongations, the skin, after being scalded or macerated in cold water, should be immersed some time in a fluid, such as alcohol, alum-water, or a very weak solution of corrosive sublimate, which gives a degree of consistence to the epidermis, which may then be separated mechanically. The epidermis being formed of layers, decomposes also by lamellæ, from maceration in water.

232. There are different methods of preparing the integument. As it is often sufficiently thick in certain animals, or even under the human heels, to offer a tolerable extent of surface for making sections, it can be cut into thin slices in different directions, and these placed under the microscope. It is principally by cutting such lamellæ perpendicular to the surface, that the sudorific ducts, the secretory organs of the epidermis and of the colouring matter, the bulbs of the hairs, the follicles, and nervous papillæ will be seen, and better even than when the cuticle has been previously detached.

233. In regard to the fibrous tissue of the *dermis*, it is very well seen on the parts when fresh, by tearing it in different directions with curved needles; but the fibres become still more apparent by submitting the der-

mis to certain preparations, as tanning or macerating it for some time in a weak infusion of gall-nuts or oak-bark, or a concentrated solution of alum; these three substances render the fibres imputrescible, by converting them into leather, while at the same time they become harder and drier.

234. To see the papillæ, exhalent vessels and excretory canals for the perspiration, at their exit from the dermis, the epidermis must be raised slightly; so as to detach it from the corium, and the above different parts are then seen passing from one to the other structure.

235. PRESERVATION.—The integument of mammiferous animals can be preserved either in a dry or wet condition. If it is intended to keep it merely in the form of a *fur*, that is, with the hair left upon the skin, the latter is *dressed* after the manner of the furriers, by freely moistening the fleshy surface of the skin, when warm rather than cold, with a saturated solution of 3 parts alum, and 1 of common salt, and powdering it over afterwards, plentifully, with a mixture of the same ingredients. When the skin is dry, it is moistened afresh, so as to well imbibe these salts, and this is repeated during eight or fifteen days according to the strength of the skin. The alum *taws* the gelatinous fibres, and the salt preserves their suppleness. After this stage of the operation the remainder of the salts is removed by scraping the skin with a blunt knife, in doing which the cutaneous muscles still adherent to the dermis are removed. Care must be taken to scrape from behind forwards, for in the contrary direction the skin will be torn. Instead of alum, the sulphate of

iron may be used, but it causes the skin to shrink by contracting its fibres too much.

236. To give more substance and flexibility to furs they are plastered over with the composition described before at ¶ 117. A layer of it is applied about an eighth of an inch thick upon the inner surface of the skin, which is then folded with the fleshy sides in contact, and left so for a day; the paste is then removed by scraping the skin with a blunt knife and drying it by powdering it over with pulverized plaster, or white clay. This earth imbibes all the grease which may remain, and is to be removed from the skin by scraping. If a single application does not suffice, it should be repeated.

237. The best method of preserving furs from the attacks of insects, is to moisten them with an alcoholic solution of corrosive sublimate which is poured at intervals and in very small quantities upon the skin, betwixt the hairs. This liquid threads its way along the hairs and poisons the insects; this process may become, however, dangerous when employed for furs worn about the person. If the fur can be moistened entirely, without inconvenience, it may be steeped in the aqueous solution of corrosive sublimate (the composition of which has been given, ¶ 121), and afterwards allowed to dry.

238. The integument can be also preserved by simply drying it in the air, but as insects readily attack it in this condition it must be moistened slightly, after desiccation, with the alcoholic or aqueous solution of corrosive sublimate, and upon both surfaces. Most anatomists varnish these preparations to preserve them from

insects, but besides not effecting this object very well, the varnish glues them together and renders them more or less transparent and brown, which has altogether an extremely unsightly appearance.

If it is wished to preserve preparations of the skin to study its structure, they must be kept in some preservative fluid.

AVES.

239. DISSECTION AND PRESERVATION. — The proceedings employed for dissecting and preserving the integument of Birds are precisely the same as for the Mammalia, only the feathers should be cut off previously, near to their insertions, so as to be no encumbrance, and that the latter with the cutaneous muscles attached to them may be readily examined.

240. Preparations of the beak are made (as are also those of the claws of Mammalia) by immersion for some minutes in very hot water or by protracted maceration, which separates the horny mandibles from the bone. The texture of the upper mandible is much denser and more compact than that of the lower; it is harder also upon the dorsal surface than the edges, exactly as in the claws, whence it happens that while the mandibles wear away at their extremities, they still remain constantly pointed; the above difference in solidity is easily proved by cutting them transversely.

REPTILIA.

241. DISSECTION.—Preparations of the integument of Reptiles are made generally like those of Mammalia,

excepting in the Anourous kind, where it is useless to submit the skin to any process for raising it from the surface of the body.

The structure of the *epidermis* can be very well studied in the exuviæ of serpents, but the *dermis* must be removed by the ordinary methods, if there is no intention of studying the muscles which are fixed to it. To examine these last, the skin of the animals must be detached with the scalpel, commencing along the dorsal region, where the scales are unprovided with muscles, which are found chiefly along the sides and under the belly. As the skin is turned down, which adheres but little to the body except by these muscles, they are cut across where they are passing from the ribs to the scales, with fine scissars, leaving their ends, somewhat long, attached to the scales, so as to find them in their place when the skin is examined from its internal surface; but in detaching the skin care must be taken not to pull it so as to tear the muscles passing from one scale to the other. These muscles, like all small organs, should be dissected under water, by fixing a strip of integument with pins, upon a plate of cork.

242. PRESERVATION.—To preserve the integument of Reptiles in a dried state, the methods in general use for the Mammalia are employed; but then it is very little adapted for the study of its organization, and it had much better be preserved in fluid. Those fluids must however be avoided which alter the colours, since the scales or naked skin of these animals readily lose the tints which often constitute specific characters.

CHELONIA.

243. DISSECTION AND PRESERVATION.—It is easy to detach the integument from the neck and limbs, where it adheres only to the muscles by a loose cellulosity; but this is not the case upon the carapax, where it is found resting immediately against the bones, and upon it the scales, which in most of the species adhere by their whole surface. To remove the integument it is necessary to macerate it some days in water, until it begins to lose its attachment, and then its separation may be aided mechanically with the scalpel. As to the scales, they may be raised from the subjacent skin by boiling water, which dissolving a portion of the *dermis*, facilitates our means of detaching them, precisely as occurs in the nails and hoofs of Mammalia, like which structures they are to be studied.

PISCES.

244. DISSECTION AND PRESERVATION.—The methods employed for dissecting the skin of Fish, are the same as for the other Vertebrata. It should, however, be detached with much caution, and without reversing it, which would cause the scales to drop out. To prevent this, the blade of a knife is glided flatwise under the skin, which is thus separated by disuniting its attachments, without elevating it too much.

The integument of Fishes is preserved like that of other Vertebrata, it being merely remarked, that the extremely fugacious colour of the scales alters as much in the dry state as in most fluids.

SECT. II.—ARTICULATA.

ANNELIDA.

245. DISSECTION.—The *epidermis* of the Annelida can be easily separated by macerating these animals for some days in water, oil of turpentine, a weak acid, or even alcohol, when the above membrane separates, the more readily too, the nearer the creature is to a *moult* or change of cuticle; but in these natural sloughs there always exists a new epidermis beneath the old cast one, so that the *rete mucosum* is not exposed. If, however, the body is submitted to heat, the new epidermis is also detached, and the mucous tissue disclosed; the epidermis may sometimes be removed mechanically.

246. PRESERVATION.—The integument of the Annelida may be preserved in a dry state; and for this purpose it is useless to submit it to any previous preparation, nearly all of them being deprived of pilose appendages. It is sufficient to stretch the skin with pins upon a bit of cork; let it dry, and then wash it over with corrosive sublimate; but the best plan is to preserve the integument in some fluid which will least alter the colour.

MYRIAPODA.

247. DISSECTION.—In studying the tegumentary system of the Myriapoda, the same general methods must be used as for that of insects. It need only be remarked that, from the elongated form of their bodies, these animals are very likely to be opened, either from the dorsal or ventral aspect, as in the Annelida, but as

the lips of the incision will then have to be pulled aside, it is plain that the natural relation of all the parts must be displaced. It is better therefore to dissect them, as in Insects, from the side of a longitudinal section. It is convenient for opening the body of these animals, to fix them upon a very narrow and convex plate of cork (§ 51), letting the feet hang down upon its sides, so as not to be in the way of the dissector.

248. PRESERVATION.—Preparations of the integument are preserved, precisely like those of Insects.

INSECTA.

249. DISSECTION.—The two principal layers which constitute the integument of Insects, may be very often mechanically separated, especially in those species, whose external crust is not very solid, as in the genus *Cantharis*, but in a great number, the integument of which is very hard, this immediate separation is impossible. The two layers may however be distinguished, by cutting through them very obliquely, so as to give more surface to the section, and in all Insects, they are easily separated by macerating for some time in hydrochloric acid diluted with water. This menstruum dissolves the horny parts, and the integument may then be divided with facility into two lamellæ, of which the external, not fibrous, is the *epidermis*, the internal, fibrous, the *dermis*. In the articulation where the integument is soft and yielding, these layers can be separated without maceration.

250. As to the colouring matter, the outer surface of

the epidermis need merely be scraped in places, where the colour is neither brown nor black, to raise the external varnish upon which the bright colours depend. In those cases however, where the spots are due to a colouring matter placed upon the internal surface of the dermis, those parts of it and of the epidermis, which correspond in position to these spots, are frequently colourless as glass, and the colouring matter, which has the consistence of a pigment, is easily raised by the finger. Sometimes the solid parts are found coloured slightly brown, but only where the internal colouring matter is of the same hue. When on the contrary it is red, blue, green, yellow, white, or some vivid colour, the epidermis and dermis are generally uncoloured, and the colouring matter can be raised from within the latter with the greatest facility.

251. To separate the hard and horny pieces from the soft parts, in order to make what may be called the *skeleton*, maceration in water is employed, as for the bones of the Vertebrata, by which the soft parts decompose by putrefaction, and leave the tegumentary pieces exposed. If it is wished that these last should remain united to each other by their ligaments, they must, like the bones, be removed from the water, just at the moment when the other parts are decomposed, but not the ligaments, which resist putrefaction much longer; they are then taken out, well washed in fresh water, and having been cleaned with a small brush, left to dry.

These pieces being nearly all external, little can be seen of their assembled details, except in preparations showing different sections. The one most suitable for

the study of other organs, is that which displays the internal profile of the right half of the body.

In making preparations of very large Insects, the pieces separated by maceration can be joined together, as is done in making artificial skeletons of bones, but as these pieces are in general very small, it is not only very difficult, and almost impossible, to unite them all, but the preparations have a very bad appearance, from the slender pieces bending in all directions as they dry; and hence, it is far better to make natural skeletons of them, with the pieces left united by their own ligaments.

252. In making preparations of the *dermo-skeleton* of Insects, and of Articulated animals in general with a solid integument, the body is macerated in water, so that the flesh, but not the ligaments uniting the pieces, is dissolved. The body is afterwards cut with fine scissars if the specimen is large, or with the *microtome* (§ 72) if very small, into two lateral halves, taking care, by sacrificing one half, not to approach too near the median line. The incision being made along the back and belly, it often happens that the two portions still hold together, by some internal pieces which are not seen; in that case, the pieces of the side to be sacrificed are removed bit by bit, care being always taken not to disturb those which are to be preserved, and the body being once opened, the internal pieces may be cut as is judged proper.

This first stage of the operation done, the half to be preserved is fixed upon a plate of cork, with pins which are placed *between* the parts, not *into* them for fear of damaging the preparation, which is then immersed in a basin of water. The fluid floats out all the loose parts

which are removed with forceps, those which are still adherent being afterwards detached by a scalpel or curved needle. When the preparation is well cleaned, it is re-fastened upon a plate of cork, with pins which are never to be stuck into the pieces themselves, and each of these is then replaced in its natural position. In this state the specimen is allowed to dry, and removed afterwards to complete the re-adjustment; in other words, to clear off with fine scissars or the *microtome* all the parts which do not belong to the preserved half. To effect this last operation, the very moment is selected when the crust is not quite dry, so that it may not break by the shocks communicated to it in cutting it with the scissars; if it is already dry it must be moistened a little with a wet brush, so as to give it the necessary degree of flexibility. At other times the section may be horizontal, and the subsequent proceedings employed in other respects the same.

The external crust of Insects, which have remained a long time in spirits, and which would often serve no other purpose, may be advantageously used for making such dried preparations, as in these specimens the soft parts are either so contracted by the liquid, when strong, that they are already detached from the solid pieces, or else the flesh is more or less decomposed.

253. PRESERVATION.—Preparations of the integument of Insects, like entire specimens, are preserved easily in liquid; still, the fluid used will often alter the colour, and the preparations end by rotting, so that it is much better to preserve them in a dry state, when they undergo no change, and can, besides, be readily handled.

As to the isolated pieces obtained by complete maceration, it suffices to dry, and wash them over with corrosive sublimate and fix them in a cabinet; complicated preparations require more care. For retaining them, pins planted vertically in the most solid piece, are fixed upon a small cylindrical support of cork, attached to the box. By these means they can be removed and replaced, with ease, and if the preparation shake about, a very small bit of cork is fastened below it, traversed by the pin. This cork compresses the preparation by its elasticity, and keeps it firm.

Very small pieces which cannot be thus transfixed may be fastened upon sharp-pointed strips of paper or pasteboard, or simply upon plates of glass, by fixing them with isinglass, or gum.

CRUSTACEA.

254. DISSECTION.—The shell in the Crustacea is divested of its soft parts exactly as in Insects. It need only be remarked that the carapax can be best obtained distinct by seizing upon the period when the animal is about to moult; the flesh then separates with the greatest facility from the old shell, which can be raised as a foreign body, wherein the living creature is moulded; the animal must not however be too near its moult, for then the internal prolongations are too much softened and out of shape.

In the membranous parts of the integument the different layers of the *dermis* can be easily seen, and by maceration in hydrochloric acid may be traced into parts previously solid, so as to be satisfied of their continuity.

By this preparation also, the *epidermis* is easily separated and is shown to be alone coloured, and not fibrous.

255. PRESERVATION.—The proceedings for the preservation of the portions of the external crust are precisely the same as in Insects.

Large concave pieces, not very solid, which in drying would readily lose their shape, may be preserved by pouring into them plaster, which retains it by forming an internal mould, and may be removed every time it is wished to examine the preparation.

ARACHNIDA.

256. The dissection and preservation of the integument of the Arachnida is conducted in the same way as for Insects and Crustacea.

CIRRHIPEDA.

257. For preparing the integuments of the Cirrhipedes the same process is employed, generally, as for Crustacea.



SECT. III.—MOLLUSCA.

CEPHALOPODA.

258. THE integument of the Cephalopoda is easily raised in shreds without the aid of a scalpel, especially in individuals which have been kept in alcohol, and can be then submitted to the microscope to study its texture. It is preserved like the other soft organs in fluid.

As the soft body of entire Cephalopods contracts much in alcohol, it is first to be placed in a weak mixture of the latter and water, and gradually into a stronger, as pointed out in speaking of preserving fluids (§ 113, 136).

GASTEROPODA.

259. The integument of the Gasteropoda can only be separated in some species and then in very small shreds. Although the capsule of the shell in *Aplysia* is very fine and formed of two layers, an external and internal, it contains, besides, distinct parallel, and nearly transverse fibres, which appear to be muscular, so that each lamella of the integument is extremely fine. In endeavouring to raise one of these by tearing it from the muscular layer, it is sometimes detached, but in very small portions.

These animals are preserved with their integument in fluid, but its structure is then undistinguishable.

ACEPHALA.

260. The integument of the Acephala Ostracoderma is prepared and preserved like that of other Mollusca, namely:—by detaching it in some small shreds, by tearing a fine layer from the external surface of the muscles, and there are then perceived upon its borders, where the muscular fibres cease, small greyish, more or less transparent and spongy-looking particles, belonging to the integument. They are also to be distinguished by cutting small lamellæ, perpendicular to the surface, the border of which is occupied by a ridge of integument.

SECT. IV.—*RADIATA*.

ENTOZOA.

261. IN order to separate the *epidermis* from the *corium*, the body must be macerated for some days in water, when it may be raised easily enough in small strips, and preserved by drying upon plates of glass.

To keep these animals in fluid, they must be first cleaned by washing them well in lukewarm and cold water, alternately, with a soft brush, as recommended by *Goeze*, and this is continued until the water is no longer viscid, when they are afterwards put into dilute alcohol, composed of one part of spirits of wine, and six of water, the strength of the fluid being gradually increased.

ECHINODERMATA.

262. DISSECTION AND PRESERVATION.—The integument of the Echinoderms is prepared like that of the Vertebrate and Articulated animals, either by attempting to remove the *epidermis* at once, by dissection, which is easily done in the *Holothuriæ* and *Echini*: or else, where the skin is encrusted with small calcareous particles, as in *Asterias*, the operation may be facilitated by scalding the integument, or macerating it for some time. The *epidermis* being removed, the colouring matter is found in a mucous state, and below it, the *dermis* pierced by its numerous holes, either for the passage of the feet, or the respiratory tubes.

In order to see the circle of calcareous pieces which

gives attachment to the tentacles, surrounding the mouth in *Holothuria*, a circular incision has only to be made in the integument of the body, a few lines from its anterior extremity, and it is discovered immediately beneath the nervous ring which surrounds the œsophagus.

263. The shell of *Echinus* being very complicated, is susceptible of many modes of preparation. If it is wished to preserve the spines in their place, it is sufficient to let the skin, which envelopes the shell, dry, it being their only bond of connection; as it is exposed to the attacks of insects, it must, when dry, be washed over with corrosive sublimate. In this state the membrane becomes very friable, and the spines fall out upon the least movement, so that these preparations had better be preserved in some non-acid fluid.

If the shell, properly so called, is to be had separately, it is sufficient to remove the skin clothing it mechanically, and to brush over the calcareous part, so as to remove all that remains of it. To get an internal view of the shell, one of the longitudinal sutures which separate the series of pieces composing it is to be forced open with the blade of a cutting instrument, (¶ 75), by trying it successively at several points. These sutures open easily enough, but it very often happens, that the transverse become disunited also, and the pieces have to be rejoined. It is advisable therefore to sacrifice one half of the shell, by making a hole, which is enlarged by degrees, until but one-half of the shell is left, leaving however a circle of moderate size around the great inferior opening, and another around the superior pole, so as not to disturb either the pieces of the lantern, or those

surrounding the anal orifice. As to the vertebræ of *Asterias*, they may be exposed by cutting horizontally through the entire body of one of these animals a little above its middle, and removing all the soft parts, which is very easily done. To obtain the internal aspect of a ray, the middle suture of the bodies of the vertebræ is carefully slit open.

The small feet can be very well injected from the vessels which conduct the fluid that places them in erection, and with the microscope, the muscular fibres of their second tunic are very well recognised.

ACALEPHÆ.

264. The cuticle of the Acalephæ, can be removed by macerating the body some time in fresh water, and having floated out a strip of it under this fluid, a plate of glass is brought beneath it so as to raise it up, and it is then left to dry, remaining fixed upon the glass.

In preserving these animals in alcohol, care must be especially taken to place them by degrees in a strong fluid, so as to prevent the too powerful contraction of the parts.

POLYPI.

265. It is sufficient in order to detach the pellicle clothing the body of an *Actinia*, to place the animal some time in fresh water, where it soon perishes, and the skin is so easily detached as to be removed with a hair pencil.

The integument is preserved with difficulty, except upon the body itself; it may be detached however in strips, and placed on plates of glass, where they are left to dry like those of the Acalephæ.

CHAPTER III.

THE CELLULAR AND ADIPOSE SYSTEMS.

266. DISSECTION AND PRESERVATION. — The cellular tissue is readily disclosed in the Vertebrata between a number of organs, which it is sufficient to raise in order to render it more apparent; it is very distinct in young subjects, from the areola being larger, and from its being found in great abundance, added to which, many of the aponeuroses which are very distinct in old subjects, are merely cellular tissue in the young.

To recognize the structure of this tissue, all that need be done is to place some lamellæ of it in water, under the microscope, so that it may not dry up: its cellular form is readily seen by blowing into it. It can also be inflated upon the surface of the body, whenever it exists in large masses uncharged with fat. For this purpose it is sufficient to introduce the nozzle of a pair of bellows into one of these masses, when the air driven in not escaping readily, distends the cellules, which resemble then a mass of foam.

For examining the chemical qualities of cellular tissue it is best to take it from parts of the body, such as the scrotum, where it contains no vessels and cellular serosity.

The cellular and adipose tissues not forming special organs are never preserved for the purposes of demon-

stration, but are simply rendered apparent upon fresh bodies. With the exception of the first, which can be inflated and then dried, they lose their characters both in the dry or wet state.

267. The fatty mass of Insects is at once seen by opening the body of a larva along the back, and drawing aside the two edges of the incision, and fixing them to the plate upon which the animal is placed. Its two lateral lobes, more or less irregular, adhere but little to the other organs, except by the tracheæ, and are easily separated and removed from the viscera which they envelope.

In perfect Insects small lobules merely are found in the abdomen, and chiefly upon the *alæ* of the dorsal vessel, where they are seen upon raising all the other viscera, after opening the animal from the ventral surface.

The fatty mass of Insects is a part almost of too little importance to be preserved *per se* in collections. If, however, a preparation is made of it, it must be placed in some fluid which is not alkaline, as that would convert it into soap.

268. True fat lobes cannot be discerned in the Crustacea. In opening the abdomen of large spiders, along the dorsal line the fatty mass may be observed enveloping all the organs, but can hardly be preserved.

If true cellular and adipose tissue is met with in the Mollusca, Radiata, &c., the same methods as those above indicated can be adopted for its dissection and preservation.

CHAPTER IV.

OSSEOUS SYSTEM.

SECT. I.—*VERTEBRATA*.—*MAMMALIA*.

269. DISSECTION.—To study the *development* of bones, these organs must be examined in very young subjects, when they are beginning to ossify, and afterwards in adults when their development is completed. In the bones of the fœtus it may be very distinctly seen how the calcareous matter accumulates around the points of ossification, where it is disposed in fibres resembling a species of crystallization, in which the osseous substance deposits itself at first in small radiating fibres in the flat or short bones, and in a course more or less parallel in the long; also how other fibres develope between the first, so as to fill up their intervals, forming with them areolæ, the meshes of which are most frequently elongated in the direction of the bone and its apophyses. These fibres being much closer upon the surface, their intervals are at length filled up completely so as to form the compact *ivory* tissue; while towards the interior the areolæ remain larger, and form a number of little osseous columns, which cross and unite together in numerous ways to constitute the *spongy* tissue, which fills up more particularly the flat bones as well as the

short, and the epiphyses of the long; an arrangement which is chiefly remarked in bones not quite formed.

270. In order to obtain the bones in this state of pseudo-development, those of a fœtus are macerated some days in water, and the periosteum removed as soon as it becomes easily detached, and before the gelatinous parts have become sensibly altered; when in the midst of a semi-transparent organic substance the different points of ossification, with the form they assume, are distinctly perceived, and if it is wished to have them separate, the maceration has only to be continued until the gelatinous part of the bones has disappeared, and then the osseous particles, which remain unchanged, should be washed in plenty of water.

271. The property which *madder* possesses of colouring the bones when mixed with the food of animals, and of being re-absorbed when its use is discontinued, has led to its adoption as a method of studying the development of bones.

272. To study the *structure* of bones in relation to their *chemical composition*, they are prepared so as on the one hand to remove from them the earthy particles, and on the other to get rid of the gelatinous part, so as to see the particular structure which each presents. In order to separate the mineral constituents, principally composed of alkalis, the bones, either recent or dry, must be digested for some days in muriatic acid, diluted with three times its own weight of water, and at a temperature of 32° Fahr.; when the acid is saturated the liquid is renewed, until all the calcareous particles are dissolved. The specimen is afterwards placed in fresh

water, which is frequently changed in order to remove all the acid that remains, and it is thus obtained reduced entirely to its cartilaginous basis, but preserving the same form, which, as a bone, it had before the operation, though if kept dry it will harden and curl up. Instead of muriatic, any other acid, or simply vinegar, may be employed, but it is clear that those which form with lime, salts insoluble in water should be avoided. When it is wished to have the earthy part alone, the animal matters are removed either by calcination, or by boiling the specimen in a Papin's digester; the water dissolving out the gelatine, and leaving the earthy constituents exposed.

273. A ready method of effecting the *qualitative analysis* of bone, consists (after having removed the animal matter) in treating a portion of burnt bone with nitric acid, diluted with from five to six times its bulk of water; brisk effervescence ensues, proving the presence of *carbonic acid*. Filter the acid liquid after diluting it with water, and add a solution of caustic ammonia, as long as the precipitate first formed continues to be re-dissolved by agitation; then add a solution of acetate of lead, till it no longer occasions any precipitate. The dense white precipitate thus produced, consists of *phosphate of lead*, which melts before the blow-pipe, and on cooling assumes its characteristic crystalline structure. Through the solution filtered from the phosphate of lead, pass a stream of sulphuretted hydrogen, to remove the excess of lead; warm the liquid to drive off the superfluous gas, and filter; then neutralize by ammonia, and add oxalate of ammonia, as long as any

precipitate occurs ; abundance of *oxalate* of *lime* will fall as a white powder. Evaporate the filtered liquid to dryness ; ignite the residue, and wash with hot water ; the *magnesia* will be left behind in a pure form.

274. In order to make preparations of the bones when in an entire state of developement, so as to see their structure, incisions are made in them in different directions with a fine saw, but as this instrument notches the edges of the incision, they must be smoothed afterwards with a fine plane, if the specimen be long enough to admit the use of that tool. For short specimens a series of fine files may be successively used, and better still the lathe ; for this purpose the section is fixed upon a wooden chuck, with isinglass or Flander's glue, and one of the sides is then planed with a fine chisel ; being afterwards turned, the other is worked down equally, so as to reduce it in this manner to the required thickness, that of a thin sheet of paper ; the specimen may afterwards be submitted to the grindstone.

At other times the bone may be simply split, so as to see its line of fracture, and by this method the separation taking place more particularly in the direction of the fibres, they are displayed in a much neater way.

To make good preparations of the spongy tissue, fresh bones should be used in preference to dry. In the latter the desiccated marrow fills up the areolæ, and there is some difficulty in freeing them of it, except by repeated washings with essence of turpentine, which is tedious and expensive, and does not succeed very well. If, however, fresh bones are used, the required

sections are first made with a saw, and the specimen left to macerate for fifteen days in a weak alkaline ley (§131), which converts the fat into soap, and renders it soluble in water. Bones which have been macerated only in water, but have not been allowed to become dry, may be also employed. The matter contained in the cellules, being liquid, can be forced out by squirting warm water into them from a syringe, and when they are well cleared, the preparation is dried and the incisions rendered even.

275. The study and preparation of white cartilages are conducted in a very similar manner, these parts differing chiefly from bones, in being charged with a much smaller quantity of calcareous matter, though distributed more uniformly through their substance. The yellow elastic cartilages, which have more analogy with the ligaments, are prepared by cutting them into very fine lamellæ, to be placed under the microscope (§202).

276. To separate the bones of an animal, so as to study their form and relations, or re-adjust them afterwards in their place by mounting the skeleton, different methods are adopted. The quickest consists in removing coarsely the flesh and other soft parts, taking care in doing this to cut the bones as little as possible, and especially their articulating surfaces, where they are clothed with cartilages, in which notches are very easily made, and parts of the bone thus injuriously exposed to the action of water longer than the rest. Care should also be taken not to remove certain small bones, which might readily pass unnoticed, if particular attention is not paid, such, for example, as the rudimentary clavicles

of many Mammalia, the little ossicles of the ear, the ossa sesamoidea, the pieces of the hyoid apparatus, &c. The bones being stripped of their flesh, may be boiled for some hours to remove soft parts which may be still attached, and after being well cleaned, either put at once to dry, or else exposed for many months to the wet and dew, especially from December to May, during which time they will be most frequently moistened and dried alternately, or they may be artificially watered, to accelerate their bleaching; they should also be turned often. It is to be observed, that too strong a solar heat during the summer alters the gelatinous part of the bones and causes them to split, giving them at the same time a white chalky colour, as if they had been calcined.

277. Sue (*Anthropotomie*, p. 251. 1765) recommends for obtaining bones very white, to select subjects as ex-sanguined as possible, or those which have died from some lingering disease, especially dropsy. The bones are cleaned without removing the periosteum, and the skeleton is steeped for some days in lukewarm water, to clear it of the blood which it still contains; it is then plunged into a ley of 2 parts soda, 4 of quick lime, 3 of alum, and 6 of charcoal, in which it is left to macerate for ten months or more. At the end of this time the bones are cleaned, dried, and varnished over with white of egg. The above proceeding is partly that which is now generally employed, though Sue does not state the quantity of each ingredient of his ley in proportion to water. It must be remarked, however, that alum, as well as all acid substances, attacks the calcareous part of the bones, and should be therefore

carefully avoided, or the bones submitted to them a very short time. As to quicklime, it forms insoluble deposits in the water, and encrusts the bones to such an extent that it is impossible, later on, to clean them; lastly, the ley of ashes soils them; and it is better to employ that of potash or soda, as answering the purpose quite as well.

278. The best method of preparing bones by *boiling*, consists,—after having stripped off the flesh, in macerating them for two or three days, in warm water during winter, and at the temperature of the atmosphere in summer, to clear them; they are afterwards boiled for two hours in pure water, the upper surface of which is skimmed to remove the grease which floats upon it, and the bones are next taken out and cleaned with knives and brushes. After this first operation, they are boiled again for about half an hour in weak ley (§ 131), to saponify the rest of the grease contained in the bones, and render them capable of drying; they are then taken out, brushed again in cold water, and set to dry.

279. The bones of large animals, previous to boiling or maceration, should have a hole communicating with their internal cavity pierced at either end, into one of which hot water can be forcibly injected from a syringe, so as to drive the marrow contained therein, out at the opposite opening. When the bones are cleaned, they can be put into a strong ley (§ 132), which completes the cleaning of their cavity, for if the marrow be allowed to remain in them, it transudes afterwards through their substance, and renders them not only of a brownish yellow, but gives them a very rancid and disagreeable

odour. The bones if then not sufficiently white, may be bleached by dew. It is a bad plan to use a solution of chloride of lime for whitening them, as it acts upon them, and destroys, more or less according to its strength, the natural smoothness of their surface. In bones thus prepared by boiling, there is this disadvantage, that they lose their articular cartilages, as well as those uniting the epiphyses to their principal pieces, while at the same time the borders not yet ossified are dissolved and rounded off, so that they will no longer fit to each other. The blood, moreover, contained in the bones and contiguous parts becoming coagulated, or the medullary oil being brought by the heat into the compact substance of the bones, gives them a disagreeable colour, which it is impossible afterwards to remove.

280. The process of *maceration*, now generally employed, is far preferable to the above, when time can be spared for it. For this purpose the bones, denuded of their flesh, are steeped four or five days in fresh water, which should cover them over completely to some depth, so that the blood in them may be disengaged. In winter warm water should be employed, and the trough placed in a warm room; but in summer, as already stated, it is sufficient to take the water at its usual temperature. At the end of this time, when the flesh has become very pale and white, the water is renewed, and the decomposition of the soft parts left to finish; the bones are then taken out, cleaned, and placed in another trough of fresh or lukewarm water, and left therein again for some days, to remove the bad odour which the putrefying flesh has given them, and then dried for preservation.

Instead of renewing the macerating water but once, as has been said, it is better to change it frequently, and macerate in a large quantity of fluid, the bones becoming whiter by this means, though the flesh is slower in decomposing.

The marrow must be got out of the bones by the process already indicated (§ 279), and lastly the grease, by putting them for final maceration in some weak ley.

281. It will be useful to remark here, that the kind of water used is no more a matter of indifference than the vessel in which the bones are placed, but should be also taken into consideration. It should be taken from a stream or well, or be rain water which has fallen directly into a tub, and has not remained there long. But ditch water or rain which has trickled over the roofs should never be used, from their developing Confervas or green matter.

The water must be also in sufficient quantity, so that in diminishing by evaporation, no part of the bones project above its surface, as then the periosteum and flesh drying upon them tinges them of a greyish brown hue, which it is difficult to get rid of.

282. The cartilages becoming detached when maceration is carried too far, it is a good plan to prevent this happening by removing in time from the water the bones which support them, and cleaning them before the rest. As this is very liable to occur in the costal cartilages, from their being easily disunited from their respective ribs, especially in large animals, they had better be separated at the first from the ribs, leaving them, however, joined to the sternum, so as to prepare them together.

283. The *skull* in the Mammalia being formed of a numerous assemblage of bones, which easily separate in the young, should be removed in time from the macerating water, if it is not wished for it to come to pieces.

The *teeth*, and especially those which have only a single fang, escaping easily from their alveoli, run a risk of being lost in the sediment which forms at the bottom of the trough when they are very small. To obviate this, they ought to be removed with care as soon as detached, and preserved until they can be replaced upon the preparation.

284. When a disarticulated head is wanted, a specimen must be selected which has not quite reached adult age, and the larger the size of the animal, the younger generally it must be. This relation varies, however, in the class, family, and even species. In many small animals, as the Rodentia, the head can be readily disarticulated long after birth. The facility of separation will depend partly upon the depth of the bony sutures.

To separate the bones of the head, which usually interlace upon all sides, dried peas are often employed; the skull having been filled with these from the *foramen magnum* is laid in water, when they swell out, and pressing upon all sides against the internal surface of its cavity with a gradually increasing force, the disjunction of the bones is at length produced; but it may happen, also, that the sutures are so disposed as not to yield thus readily, or in the direction in which the force acts, and fractures are then the result. In placing, too, a dried head filled with peas in water, they swell out in a few hours, while the bones, softening but slowly, are broken

before they have acquired sufficient elasticity to give way. It has been recommended, therefore, to soak the skull some days in water, before putting in the peas, so that the bones may become slightly flexible.

285. The above very simple method should only be employed when no accidents can occur with it. In the contrary case, it will be better to disunite the different bones with the hands, aided by such instruments as levers, pincers, &c., which must, however, be used with great caution.

The bones which separate the most easily are commenced with, as those of the nose, the intermaxillaries, malar, upper jaw, and all that belong to the face. In certain cases the above two methods may be combined.

286. Horizontal and vertical sections of the crania of different Mammalia are extremely instructive, and may be made with a fret saw, care being taken in the vertical division not to go too near the mesial line, for fear of destroying the azygos bone or vomer.

287. In preparing the skeleton of very young subjects, and of the *foetus*, care must be taken not to remove the periosteum, and principally near the juncture of the epiphyses, as in adhering to the bones it keeps their parts together, and will disappear almost entirely in drying.

For making preparations of the primitive ossific nuclei before their union, it is advisable not to wait until maceration has destroyed the cartilage connecting them, but to remove them from the water as soon as the flesh is decomposed.

288. To see the different degrees of developement of

the *teeth*, the bones containing them should be laid open from one of their surfaces, in a subject replacing its teeth, as in *Man* between the ages of seven and twelve years. The parietes of the bones are removed bit by bit with a cutting instrument, file, or rasp, and thus the whole course of the dental canal is exposed. In making the preparation upon a subject whose anterior teeth are already replaced, those behind them are found less and less developed. Those which are about to pierce the gum, will be found applied immediately beneath, or to the sides of the milk-teeth, which they push out, and those, the germs of which are beginning to develop, will be further removed towards the bottom of the bone. In order to comprehend this arrangement more easily, the preparation has only to be made upon an uninjected subject, and macerated for some time to discharge the blood from the bones, but not until all the flesh is rotted; for if the gum became detached it would carry with it the milk-teeth, which merely hold on to it. To avoid this, the gum is first slit upon each side along the whole length of the alveolar margins, as far as the jaw-bone; its internal and external parts are then removed, leaving *in situ* the strip which retains the teeth. The bones are afterwards opened from the side, to render the young teeth apparent, and the soft parts removed from within, so as to leave only the teeth and their gums.

When it is wished to see not only how the milk and permanent teeth are disposed, but at the same time their relations to their bulbs, and the vessels and nerves of the latter, the preparation must be made upon a fresh in-

jected subject, and left, to clear out the blood, for some time in warm water, so that it may turn out a white and beautiful specimen. In other respects the process is the same as before described; care, however, being taken to preserve in its place the entire *odontogenic* apparatus. Similar preparations should be made upon children of one to two years, to show the developement of the milk-teeth.

The osseous part of the teeth presents, when broken or cut in different directions, concentric layers, indicating its mode of formation, and in the centre, a cavity occupied by the bulb upon which the tooth is moulded, terminated below by a little canal which traverses the apex of each fang, and by which the nerves and nutrient vessels enter. The intimate structure of the teeth may be learnt by making very fine sections (§ 186), and submitting these to the microscope (§ 204); sometimes it is better to break them, as the fibres and grains are thus more distinctly shown when viewed by reflected light (§ 197). If the teeth are placed in hydrochloric acid diluted with water, the calcareous matter dissolves, and the gelatinous part, which belongs almost entirely to the osseous substance, the enamel containing very little of it, is left.

289. The injected *vessels* of bones are difficult to see without being traced. In the flat and thin bones of certain animals, as those of the cranium of birds, they are to be seen through the two tables, by placing these bones between the eye and a ray of light. But they are easily exposed, by removing with a cutting instrument or file the ivory part of the bones, and are often readily

distinguished, from being contained, in their course through the spongy tissue, in osseous canals, which render them very apparent. In long or thick bones, the operation is more difficult, as it is almost impossible to trace one of the vessels, which are generally small, through the ivory substance. The work is facilitated by plunging the specimen some time in dilute hydrochloric acid, which, dissolving the calcareous matter, leaves only the gelatinous part, serving as an imbedment to the vessels. In this state the vessels become apparent, by the transparency of the matter enclosing them, and may be more easily pursued by dissection.

The following method is indicated for isolating vessels which enter bones :—The bones are macerated in dilute nitric acid, until they have lost half of their earthy particles ; they are then washed in cold water, and boiling water poured over them, in which they are left to rest for twenty-four hours, the water being kept at the temperature of about 240° Farh., without boiling. During this time the cartilaginous part, freed from the calcareous, dissolves and leaves the vessels exposed ; and they are then so slightly adherent as to fall out at the least touch. Nerves have not yet been discovered in bones, although they probably exist there.

For the mode of preparing the *periosteum* of the bones, see the ligamentous system of the Mammalia, (¶ 328).

290. *Natural Skeletons* are so called, from the several bones being left united to each other by their ligaments after maceration, all the other soft parts having been carefully removed. They are usually unsightly, from

its being almost impossible to get rid of all the flesh, which, along with the blood and grease, dries partially upon, and discolours the bones; added to which, some persons varnish them over, which renders them quite repulsive. These disadvantages have led M. Straus-Durckheim to employ the following different method of preparing natural skeletons, and which was suggested to him by the property which gelatinous parts possess of preserving by being tanned or tawed.

291. The skeleton is macerated as for the artificial kind, and when all the soft parts, with the exception of the ligaments, are decomposed, is removed to be cleaned and washed. It is macerated afterwards for some days more in fresh water to get rid of the foul odour, and then placed in a bath of alum-water and common salt (§ 116), wherein it is left for five or six days, and even longer, until the ligaments are tawed or converted into leather, and then the skeleton is mounted, the bones of which, perfectly clean and white, are seen united by small bands of very strong and white leather. To prevent insects from destroying these ligaments, which, however, they are less likely to do than those upon the common natural skeletons, they are impregnated slightly with the alcoholic solution of corrosive sublimate (§ 122).

292. For making skeletons of very small animals, the assistance of those insects which are so formidable to all collections of natural history, from the rapidity with which they destroy animal matters, as the genera *Dermestes*, *Anthrenus*, *Ptinus* (§ 13), is employed. The skeletons are enclosed, roughly prepared and dry, in boxes, along with a number of these insects, which mul-

tipling, gnaw all the dried soft parts, leaving the bones and deep-seated ligaments, which they cannot so easily get at, though in the end they will insinuate themselves, and destroy these also. From time to time, therefore, the boxes are visited, and their operations aided, by the removal of certain parts; by thus superintending their work, the proper time is seized upon for withdrawing the skeleton from these little anatomical assistants.

The agency of *ants* is frequently used instead of that of the above insects, from the expeditious manner in which they prepare chiefly fresh skeletons. For this purpose the skeletons, coarsely stripped of their flesh and placed in a box, are set over a formicary. The ants soon get to work, with such industry, that often in less than a day, the skeleton is entirely deprived of all its soft parts; but they often detach and carry away pieces which had better been left in their place, and to prevent this, the holes in the box should be made just large enough for a single ant to pass through.

293. For *articulating* or *mounting artificially* the skeletons of Mammiferous animals, different methods are employed. Most of these, however, are but slight modifications of each other, and as a knowledge of any of them will be at all times more easily gained by a little practice and observation than by the most minute description, it must suffice here to mention only the general plan upon which the above process is conducted.

As a general rule it may be stated, that the smaller the number of wires used in uniting the bones, the better will be the appearance of the skeleton, regard of course being paid to a requisite degree of firmness and

solidity. The wires should also be concealed as much as possible from view. The attitude of the skeleton had best be that of perfect rest, and all fanciful positions should be avoided.

The *vertebral column*, from its forming the central part of the skeleton, and having to support all the rest, is first to be placed in position, for which purpose it is either fixed upon a frame (§ 53), or suspended, if very large, by any convenient contrivance. As the intervertebral ligaments have been removed by maceration, they must be replaced by artificial ones of the same dimensions, made of discs of leather, cork, or in very large Mammalia, as the whales, where the ligaments are extremely thick (more than four inches), of wood. To unite the vertebræ together, so as to prevent any motion between them when the skeleton is moved, a hole is drilled through the body of each, and afterwards rendered square by means of a file. Into this an iron bar of corresponding shape is to be introduced, of sufficient length to thread all the vertebræ and false ligaments between them together. The different curves are given to this rod, which the vertebral column ought to have when mounted upon it, observing that in proportion to the weight of the latter, the curves must be made either stronger or weaker, so that they may retain the same flexures when the bar is introduced. An iron rod may be also passed through the spinal canal to ensure greater strength, and in skeletons of small size, may be surrounded with black paper or tape, so as to slip into them by friction, prevent the vertebræ from shaking, and render the intervertebral foramina more apparent.

294. The vertebral column being set up, the ribs are attached to it by two wires for each, one connecting them to the transverse process, the other to the side of the body of the vertebræ. The form of the vertebro-costal articulations should be carefully observed, so as to give the ribs as closely as possible the direction which they had in the living animal. All the ribs of one side are then fastened together by one or two copper wires, twisted in the form of a string in the intervals between them, and receiving each within it in succession. This wire is fixed in front as a point of departure to the transverse apophysis of one of the last cervical vertebræ, from whence it passes to the extremity of the first rib, and so on successively to all the rest. It is best to adjust the wire to each of these bones, wherever it is obliged to deviate from the straight direction, either by making a slight notch in the rib, or passing the wire through the thickness of the bone. Behind, the wire is fixed to the pelvis. A second chain is frequently placed over the middle of the ribs to keep them well in place.

295. The *sternum* and *costal cartilages* should be prepared and articulated separately, and as the latter being very soft when taken out of the water harden and curl up in drying, they must be fixed in proper position upon some solid body to dry, before attaching them to the skeleton.

296. For fixing the *head*, the anterior extremity of the bar which threads the vertebral column is made to enter the foramen magnum, and to curve directly upwards within the cranial cavity, so as to press against the inner surface of the occipital bone. If the skull is

light, a wire upon either side connecting its condyles with the transverse processes of the atlas, will suffice to keep it steady. But when it is very heavy, a square iron peg may be introduced from above, through the vertebral bar, where it is entering the foramen, and made to pass out through the posterior part of the base of the cranium, against which its extremity is to be bent, and so tightly secured.

297. Much of the beauty of a skeleton will depend upon its being so contrived, that in all cases the four limbs shall of themselves support the rest of the skeleton, without the addition of iron supports rising upwards from the stand. In the largest animals, this may be effected by the following simple contrivance :—

For the *anterior extremities*, a short and square iron bar is passed transversely through the body of the second or third dorsal vertebra, and beneath the one which threads all the vertebræ together. Its two extremities are perforated and project upon either side beyond the inlet of the thorax, being completely concealed, in a lateral view of the skeleton, by the expanded portions of the *scapulæ*. Two other square iron bars, provided above, with a shoulder upon which the openings in the transverse bar rest, descend, curving slightly outwards, and entering the glenoid cavity through the inner surface of the neck of the scapula, are inserted as far down the shaft of the humerus as possible, within which they terminate. A second square rod penetrates the latter also, but from below upwards, and is continued through the remaining large bones of the fore-leg, and fastened to the stand, or pedestal, through which it passes, by a

screw and nut upon its under surface. The pelvis having been attached to the sacrum by a transverse wire, traversing the latter and the two iliac bones, and secured at either end by a screw and nut previously prepared, similar bars to those used above are driven through the acetabula into the femora, and fastened within the pelvis, while another perforates the femur, the tibia, astragalus, and long metatarsal bone, if the skeleton be that of a Ruminant. The small bones of the carpus, tarsus, and phalanges are united by separate wires, and adjusted afterwards in their place.

For placing the anterior limbs in a right direction, especially in those species with an incomplete clavicle, the position of the scapulæ must be well examined upon the living subject. In the Carnivora, this bone is placed obliquely from above, downwards, and forwards, its upper border projecting considerably over the spinous processes of the first dorsal vertebræ, while in the Ruminantia and Solipedes it scarcely reaches their summits.

In a well mounted skeleton the scapulæ should be kept at a small distance from the ribs, equal to that which the subscapular and serrati magni muscles have filled up.

298. For uniting the bones of the *hands* and *feet* in large animals and preserving the means of separating without disuniting them, so as to study them more easily, they may be all threaded together with a spiral brass wire, which keeps the bones united, but admits of their being drawn apart in different directions.

Where the bones leave naturally an interval betwixt each other, as in the metacarpus, and metatarsus, all those situated in the same direction are traversed by a

common wire, which in the intervals is surrounded by a spiral coil. In this way the bones are forcibly united, and kept also at a distance from each other. As to small skeletons it is often most convenient to glue rather than unite the bones together by metallic braces, which often cause them to break; silken threads may be also used instead. Small skeletons are best put up naturally, with their ligaments, and prepared as before indicated.

When it is wished to make a preparation of several bones united together, but capable of being temporarily separated for study, the carpal and tarsal for example, the best mode is to prepare them at first as for natural skeletons. After having tawed the ligaments, they are cut upon one side, leaving only such of the opposite one as are absolutely necessary for preventing the bones from separating. Thus prepared, the ligaments may be folded several times upon themselves before they will break.

299. PRESERVATION.—Bones are the easiest parts to preserve, from their resisting the action of all ordinary external agents without being sensibly altered for a great number of years. Still, however, exposure to the air, with alternations of wet and dry weather, removes in the end their gelatinous part, and these organs reduced to their calcareous constituents become as if calcined, and white like chalk. When, on the contrary, they are sheltered from the air, as are fossil bones, they preserve their gelatine so long that it is found even in fossils thousands of years old. In collections, the bones experience no alteration, excepting the grease transuding through and yellowing them, which may be pre-

vented. It is not so with the ligaments entering into the composition of skeletons; these bodies being more or less changed in time by moisture, from which they should be kept, are attacked by insects, though less, however, when tawed, than in the natural state. Many anatomists coat them over with varnish, which preserves them it is true from moisture, but has the disadvantage of rendering them very dirty and disgusting; washing them simply over with corrosive sublimate, as explained before, prevents insects from gnawing them, perfectly preserves the skeletons, and is therefore to be preferred.

Preparations of detached bones may be fixed in glass bottles, upon cylindrical cork supports, to which they are attached by pins traversing their middle. All these specimens are placed one after another in anatomical order, and in groups, according to the same principle.

AVES.

300. DISSECTION AND PRESERVATION.—The proceedings employed for preparing the bones of Birds, are absolutely the same as for the Mammalia.

To make preparations of the detached bones of the head, very young subjects must be taken, as in these animals these bones coalesce at a very early period, and before they have attained their full growth.

A single iron support is given to the skeletons of Birds, and this terminates above in three branches, of which two short and lateral, forming a fork, pass between the two sacral vertebræ, whilst an anterior branch, very long, follows the inferior surface of the spine as far as

the middle of the neck, where it ends by a transverse bifurcation directed backwards, upon which one of the cervical vertebræ rests. The rod which passes through the vertebral canal serves, as in the Mammalia, to fasten the vertebræ and head together.

The wing bones should be secured to the side of the thorax as in a state of rest, by means of fine brass or malleable iron wire, twisted round any of the nearest ribs.

The skeletons of Birds of moderate size may be mounted, by simply using for their support iron rods traversing the whole length of the femora, tibiæ, and tarsi, and united in the pelvis by a long bracket directed forwards, upon which the pelvis, and through it, the whole body rests. Through the spinal canal there passes likewise an iron wire twisted round with black paper, which, filling up that cavity, prevents the bones from shaking. A similar wire passes into each toe, and another into the main bones of the wings. These skeletons have thus the appearance of supporting themselves.

The preservation of the skeletons of Birds is the same as for the Mammalia.

REPTILIA.

301. DISSECTION AND PRESERVATION.—Preparations of the bones of Reptiles are made precisely in the same way as those of Mammalia, and similarly preserved. It is, however, extremely difficult to make artificial skeletons of the small species, especially of the Ophidians, and it is far more convenient therefore to make them natural, still selecting the very moment when the flesh can be

easily removed for cleaning the bones, as some few days later the ligaments of the ribs become detached.

In preparing the skeleton of the larger serpents, such as the Boa Constrictor, in which the vertebræ and ribs are very numerous, it is necessary to preserve by some method their order of sequence before they become detached, so that they may be afterwards correctly articulated. The spine of the above serpent is composed of 304 distinct vertebræ, of which 252 support ribs. The skin and other soft parts having been coarsely removed, the vertebræ may be separated first of all into two parcels, the largest as just stated bearing ribs, the remaining 52 being without them. A wire or string may be passed through the vertebral canal of all the latter, and the two ends fastened, so that the bones may not come off, and thus strung together, they are placed in the macerating trough. The same should be done precisely with the remaining vertebræ, which can however, for convenience sake be divided into 6 portions, each of which will contain 42 of these bones, and of course, double that number of ribs. Each of the ribs should be detached from the vertebræ, first upon one side, and then upon the other, and as they are removed, united by a string tied round each, to one of the ends of which, before being fastened together, a coloured head or any other body might be attached, to indicate whether the series of bones belongs to the right or left side. In proceeding afterwards to mount the skeleton, no difficulty or confusion will arise. A wire must be passed through the bodies of the vertebræ, and one through the canal to

support the head, different curves being given to it previously to its insertion. Each rib will be articulated to its transverse process, by a wire passed through the latter and its neck, the twisted ends being turned downwards and inwards, so as to be out of sight. The extremity of almost all the ribs will have to be drilled for the insertion of fine pins, which are to support them upon the stand. The head should be macerated separately, and carefully watched, so as to keep the bones if possible united by just sufficient ligament, as to render any braces needless, except for the mastoid, tympanic, and inferior maxillary bones, which are but loosely connected. Particular care should be also taken of the teeth, that they are not lost.

As to the skeletons of the Batrachia, it is very easy to make them artificial, with the exception of the feet, the ossicles of which are too small to be joined together by wires.

CHELONIA.

302. DISSECTION AND PRESERVATION.—When it is wished to prepare the skeleton of a Chelonian, having stripped it of its flesh, it is put to clear in warm water, previous to submitting it to maceration; but as the scales clothing the carapax detach very slowly by this method, recourse must be had to boiling, if it is soon to be completely exposed. To see the interior of the trunk, the plastron is usually removed, by cutting it upon each side between the slits for the exit of the extremities; and in order to have an internal profile,

the carapax may be cleft along the median line, or else at a little distance from it, so as to leave the vertebræ entire.

Preparations of the bones are preserved like those of the Mammalia.

PISCES.

303. DISSECTION AND PRESERVATION.—It is very easy to divest the bones of Fishes of the flesh adhering to them, slight ebullition for some minutes in water being sufficient to detach it, as the gelatinous parts dissolve very readily by boiling, and the bones are obtained perfectly white. However, as they still contain some grease, it will be well to macerate them afterwards for some days in a weak ley, which very easily penetrates the generally small and thin bones. As the bones of Fishes are very loosely articulated to each other, they can scarcely be restored to their place, after having disjoined them, to make artificial skeletons, though sometimes, however, it may be managed, by refastening the ossicles by means of small braces of soft iron wire; but for this purpose it is best to have a natural model, indicating the situation of each bone, as, without this, one would hardly succeed.

304. In preparing entire skeletons of the Osseous fishes, Mr. Knox recommends removing first the pelvic bones, with the fins which they support, and the pectoral extremities from their articulation to the temporal bone, detaching along with them also the small and rudimentary sternum which lies between them. The hyoid apparatus, including the hyoid bones, branchial

arches, and branchiostegous rays, is next to be detached from its connection with the styloid processes of the temporal bone. These different portions of the skeleton should then be put into water, while the spine, with its ribs and processes, and the inter-spinal bones supporting the fins, are immediately cleaned. The thin cuticular covering of the fins may be removed in a sheet with a pair of good forceps, and the dark pigment beneath, swept off by a tooth-brush in warm water. A wire is to be passed repeatedly down the spinal canal, and through that formed by the inferior vertebral arches, and the preparation allowed to remain in abundance of water for a day or two. The pectoral extremities will next require to be cleaned, and then the hyoid apparatus, the vascular fringe supported by the branchial arches, being cut off close to the latter, but on no account removed, as the whole assemblage of bones would in that case separate. The *membrana branchiostegi* is then to be cautiously dissected off the rays, as they are very slightly connected to the hyoid bone. The pelvic bones are cleaned in a few minutes. The principal masses requiring to be removed from the cranium are the temporal and masseter muscles, in doing which the only bones in danger are the small chain of osselets, forming the external and inferior wall of the orbit, and which had better therefore be detached at once, and strung on a delicate wire to be attached to the head when it is cleaned and dried. The remaining cranial bones will be found connected by pretty strong ligaments. The brain having been carefully washed out, the skeleton is allowed to remain an hour or two under a gentle current of pure water.

Each portion of it may then be taken out, and fixed in position upon a clean board with pins, so as to get dry. The hyoid apparatus will require to be distended with portions of Bristol board, so as to preserve the relative width of the gill covers. The head is suspended in a frame, and the jaws, gill covers, &c. fixed, so as to display as much of their surface as possible. The hyoid apparatus, then the pectoral extremities, being replaced, the spine is connected to the head by a slender stick, cut so as to fill up accurately the foramen magnum, and thrust for a short way down the spinal canal. The articulations required are extremely few, and must be done with soft iron wire. A hole should be drilled in the bones, and the ends of the wire, after being passed through, rolled round separately, until the bones are brought in close apposition, and the articulation feels firm. This method is preferable to twisting the two ends of the wire together, as the bones of most fishes will be torn by this process.

305. The *cranial* cavity of the Cartilaginous Fishes, the skeleton of which generally requires still greater care in preparing, must be stuffed with tow in drying, and a malleable iron wire, simply drawn through an oiled cloth, passed along the spinal canal, to keep the spine of its natural length and shape, and prevent the canal from closing.

Preparations of the detached bones of the cranium must be made by uniting them by soft iron wires, passed through each, and twisted in a coil between them; the ends of the principal wires are then attached to a central rod, which revolves between the upper ends of two

vertical bars fixed at the extremities of the stand, so that the assemblage of bones may be turned round to view it in different directions.

306. In making the skeletons of Osseous Fishes, care must be taken not to lose certain small accessory pieces, very often as fine as threads, supported by the ribs laterally, and which plunge into the flesh to give attachment to the lateral muscles of the trunk.

When the Malacopterygian Fishes are prepared, the fins of which enclose a multitude of small osseous granules, they must be removed previously altogether, with their inter-supra-spinous and inter-sub-spinous bones, as well as those of the four extremities, in order that the above granules may not separate by boiling. If, however, there is time, the fins may be still removed in one piece with their rays, even upon the body of a fish which has been boiled, without separating these ossicles; but it is difficult to do so, and, as the parts become very soft, these preparations can hardly be kept in place for drying.

When it is wished to preserve the membranes which unite the rays of the fins, they must be prepared by stretching them out to dry; for, when once they are hardened, they cannot be softened sufficiently to give another shape to the fin.

307. The *teeth* of Fishes not being always implanted in bony sockets, but simply in the gum or other parts of the mucous membrane of the mouth, fresh specimens must be used if it is wished to preserve them, for a slight maceration or boiling will detach them, and so they are lost.

The iron support on which fishes are placed differs from those ordinarily employed for Mammalia and Reptiles, the posterior one, which sustains the tail, not being placed in the median line, being prevented by the inferior apophyses of the vertebræ; and it must, therefore, have its fork made in such a manner that the principal stem is in the direction of one of the prongs, so as to be placed to the side of the median line, or, in other words, laterally.

308. The methods of dissecting and preserving the so-called skeleton of the Articulata have been described in the section upon their Integuments, to which system of organs it properly belongs.

SECT. II.—MOLLUSCA.

FROM their serving like the osseous system of the Vertebrata, as a means of support to the soft organs of the animal, this is the most proper place for noticing the cartilaginous pieces, shells, &c., of the Mollusca.

CEPHALOPODA.

309. DISSECTION.—It is sufficient to make a longitudinal incision in the integument of the back of a Cephalopod, to expose its internal shell, and as the body is generally soft, its position is very well recognized by exploring the dorsal region with the fingers, before opening the capsule which encloses it. In the *Octopus* alone

this becomes more difficult, since the granules representing this concretion are very small. When the shell is external, no other preparation is required than what may be made upon the shell itself to see its structure and mode of formation, and such is managed precisely as in the Gasteropoda, of which *vide infrâ*.

As to the cartilaginous ring of the head, it must be disclosed by opening the latter from its posterior or anterior surface, so as not to injure the eyes.

The cervical piece is exposed to view by cutting into the posterior surface of the neck of the animal. Lastly, the cartilaginous bands of the fins are seen by slitting the integument along the back, and drawing aside the lips of the fissure, beneath which they are placed, but care must be taken not to destroy them, since they are often very fine.

310. PRESERVATION.—The cartilages of the Cephalopoda being very delicate, harden considerably by desiccation, and lose completely their natural form. It is better to preserve them therefore in fluid than in the dried state. Their primitive form can, however, be restored, after having been dried, by letting them soak some hours in water.

As to the shells, external as well as internal, they may be preserved perfectly dry, and without any preparation, as is done in conchological collections. But if it is wished to keep them in fluid, it must not be acid, because the pieces are most frequently calcareous.

The shells of *Loligo*, being of a horny texture and very thin, curl up more or less in drying, and may be therefore kept in fluid; but they are, however, so little

distorted, that they may be very well preserved dry, and softened afterwards in water, if it is wished to see them in their natural condition.

PTEROPODA.

311. Preparations of the shells of the Pteropoda are made like those of the Gasteropoda, and require no other care for their preservation than being kept in some non-acid fluid when soft and cartilaginous, as in *Cymbulia*.

GASTEROPODA.

312. DISSECTION. — Different preparations of the shells of the Gasteropoda are made to show their internal structure and form; as cutting them with a very fine-toothed saw in different directions, especially parallel to the columella, to exhibit its disposition.

The structure of these productions by juxta-imposed layers is very distinctly shown by cutting them very obliquely to their surface, and these plates may be often counted, as in many species, such as *Cypræa*, the animal gives at each stage of its growth an external layer to the whole shell, often of a different colour from the one preceding it; and as these depositions are many times renewed, alternate layers of very varied tints are observed.

313. What proves, moreover, in an evident manner how shells are constructed, are the repairs these animals make in them when broken. Many examples of this are seen, and may be caused to be performed under our

very eyes, by making a small breach in the last turn of the spine in *Helix*. If, however, the fracture is too large, so as to expose a considerable part of the body, the animal does not repair it, and perishes by desiccation ; or even if made where the mantle cannot reach it, no reparation takes place.

314. By macerating shells in acid (the hydrochloric or nitric diluted with water), the calcareous part being thereby dissolved, there remains only a substance apparently mucilaginous, not fibrous, but divided into transparent very fine lamellæ ; and the epidermis (*drap-marin*) remains intact, showing that it is not composed of calcareous substances. The epidermis may be detached by itself, by macerating the shell in weak vinegar. The acidulated water dissolves the part of the shell subjacent to that pellicle, which then becomes detached. In a number of species the epidermis does not even exist.

315. To discover internal shells, a crucial incision is cautiously made upon the adherent portion of the mantle, care being taken not to thrust the instrument in too deep, so as to disarrange the shell, which is not at all adherent.

316. PRESERVATION.—Nothing is easier than to preserve shells, since they experience no alteration, either in contour or composition, except when exposed very long to the temperature of the air, so that great collections have been thus formed for many years past, with a view of studying them in a zoological relation, as well as by the agreement of their forms and colours. Where, however, the animal is to be preserved in their interior, they must be kept in spirit, and the apex of the last

whorl may be broken off to allow the fluid to reach the whole body of the molluscous inhabitant.

ACEPHALA.

317. DISSECTION AND PRESERVATION.—The shells of the Acephala are prepared and preserved precisely as those of the Gasteropoda. By macerating them in water holding acid in solution, there remains, as in the shells of the latter, a part apparently mucilaginous, not fibrous, composed of many very delicate lamellæ, of which each, without doubt, belongs to one of the different layers of which the shell is composed.

The epidermis with which some are clothed, makes little or no effervescence in acid fluids, which shows that, as in the Gasteropoda, it does not contain calcareous salts, and is probably composed of the mucous matter only, which constitutes the base of the proper substance of the shell. By the microscope, especially in the epidermis of *Unio pictorum*, a cellular structure is perceived in some parts, and a grumous in others, but no fibres; and these cellules appear to be due to a frothy condition of the matter of the epidermis at the time when it was deposited, and not to a true organization.

BRACHIOPODA.

318. The shells of these animals are prepared and preserved like those of the other Mollusca.

SECT. III.—*RADIATA*.

ACALEPHA.

319. DISSECTION AND PRESERVATION.—The preparation of the solid pieces of the Acalepha, consists simply in freeing them of the soft parts, which is readily effected, either by removing the latter with a scalpel, or letting them macerate for some time in water, so that the flesh detaches of itself. To preserve them they must be kept in fluid, such as weak alcohol.

POLYPI.

320. DISSECTION AND PRESERVATION.—The Polypidoms, being either horny or stony, may be easily obtained separately, either by maceration, or simply removing mechanically the organized substance, after having dried the whole. Different sections can be made of them, and principally perpendicular to their axis, to see the disposition of their substance in concentric layers, but for that purpose it would be as well to polish the cut surface, so as the better to recognize its texture. It is also instructive to break the Polypidom and examine the fractures.

The Polypidoms require no more care for their preservation than the shells of the Mollusca, being, like them, of a more or less calcareous substance, unchangeable by the air, and not liable to the attacks of destructive animals.

INFUSORIA.

321. DISSECTION AND PRESERVATION.—The *loricæ*

of the Infusoria are too small to be submitted to any preparation, further than that of their simple isolation, by producing solution of the soft parts. As many of these bodies are silicious, they are readily obtained by immersing these animals in some weak mineral acid, as the nitric or hydrochloric, which dissolves them without attacking the silex.

According to the beautiful observations of M. Ehrenberg, an immense number of these little shells are found in a fossil state, either in certain kinds of Tripoli, or in silex.

These bodies are too small to be preserved, otherwise than "en masse," (§ 213).

CHAPTER V.

LIGAMEN TOUS SYSTEM.

VERTEBRATA.—MAMMALIA.

322. DISSECTION. — The *ligaments* being generally short, and approximated together in great number in certain parts, such as the carpus and tarsus of Man, and other Mammiferous animals, would be readily thrown into confusion if many of them were cut through the middle without removing them, as is done with the

muscles; for in that case, their fibres separating would form tufts, in the midst of which it would be impossible to make them out. It is advisable, therefore, to examine well their points of attachment, and remove one afterwards entirely, scraping away any fibres which may remain, before cutting through another. But, as many very different ligaments are often found superimposed, they must be cut into with the greatest caution, so as not to injure those placed beneath. The articular capsules especially must be removed with great dexterity, so as not to remove also their synovial bursæ.

323. The *synovial sheaths*, which are prolonged more or less upon certain tendons at their exit from their fibrous grooves, not being supported from without, and lying close upon the adjacent parts, are often difficult to perceive, but may be rendered very apparent by inflating them with a fine blow-pipe.

324. When the muscles and ligaments are being dissected, which are commonly done at the same time, care must be taken in the neighbourhood of the articulations, not to hurry matters too much, and to raise the tendons cautiously, only after having assured ourselves whether they adhere or not to the capsules, or are accompanied by synovial sheaths.

325. When the articulation, the ligaments of which are to be preserved, is nearly stripped of the muscles and other parts which are not to remain, it will be as well to cut the bone at a certain distance from the articulation, so that the specimen may be more readily handled, and in this state finished by isolating carefully the ligaments, so as to render them distinct. This

being completed, the part is put for one or two days in warm water, so as to abstract as much of the blood as possible, unless it is preferred preserving it with the periosteum and bones, deeply coloured by the above fluid. In this latter case the specimen is simply washed in plenty of water to remove any thing that might soil it. After this first operation, the preparation is slightly dried; and in order that the articular capsule may not adhere to the subjacent parts, some are in the habit of making a small opening therein, and introducing some wadding, such as cotton, flax, or hair, taking care to grease or oil it previously, to prevent its sticking when it has to be afterwards removed; but it is better still to fill the cavity with millet seeds, which insinuate themselves easily into the minutest corners, and do not adhere, owing to their smooth surface. Others distend these capsules with air, which they introduce by an opening pierced very obliquely in their parietes, but in this case it is plain that the capsule must not have been previously cut into.

326. To remove the grease which fills the cavities of the bones, the best plan is, when the latter are open, to get rid of the greater part by mechanical means, and to soak the specimen afterwards for some days in the ley (§ 131); the alkali combining with the grease converts it into soap, which may be removed afterwards by washing in lukewarm water, and scrubbing the preparation with a brush.

327. In order to dry these anatomical preparations, it is recommended to soak them some days in equal parts of essence of turpentine and alcohol; but, upon the one

hand, this menstruum is very dear, and on the other, it does not dissolve all the grease, as it is said to do, while at the same time the turpentine always leaves in drying a crust which renders the specimens foul and sticky. This method is besides very useless, since the anatomical pieces are never so large as to corrupt before drying, and the employment of the ley fulfils much better the required conditions.

328. To make a good preparation of the *periosteum*, a well injected subject must be selected. After having freed the bones of the muscles and ligaments which fix them, leaving, nevertheless, a small end of the latter as well as of the tendons, a sheet of periosteum is removed with the aid of a very flat, but not cutting, spatula, such as the ivory handle of a scalpel. It is then fixed upon some support to be preserved.

Preparations of the yellow ligaments are made like those of ordinary ligaments.

329. PRESERVATION.—In most anatomical cabinets the ligaments are preserved in a dry state, and rarely in fluid; the former method being least expensive, and the preparations occupying less room, and being easier to handle, while the fluid, commonly alcohol, and the jars which are employed in the latter are very dear. This procedure is not, however, to be recommended, for the parts become so distorted that it is impossible to see anything. However, as the custom exists it had better be pointed out.

330. To preserve specimens in a dry state the following method may be employed; after having completed the dissection, and the parts being as much as possible

freed from grease, the preparation is plunged either in a slight decoction of gall nuts, strengthened from day to day, or in an aqueous solution of sulphate of alum and common salt (§ 116), and left in one or the other of these liquids from six to eight days, and in the first, even more than a month, since it does not attack the bones. These fluids tan the ligaments and convert them into leather, without hardening them much, and the preparation is afterwards dried. The sulphate of alum has, besides, the advantage of saponifying the grease which still remains in the ligaments, and rendering them easy to dry. Once dried the ligaments are saturated with an alcoholic solution of corrosive sublimate, which prevents insects from attacking them.

To these dry preparations, which lose their colour, flexibility, and even form, those preserved in fluid are much to be preferred. The periosteum, which does not differ from the white ligaments, but by its disposition and vascular texture, is preserved precisely in the same manner; it must not be injected, however, with a greasy or resinous substance, if it is wished to preserve it in alcohol.

331. The ligamentous system of Birds, Reptiles, Chelonians, and Fishes, is dissected and preserved as in the preceding class of animals.

The ligaments of the Articulata, Mollusca, and Radiata, are prepared and preserved with the integument, of which they are modified parts.

CHAPTER VI.

~~~~~  
MUSCULAR SYSTEM.  
~~~~~SECT. I.—*VERTEBRATA*.—MAMMALIA.

332. DISSECTION.—Although the muscles are very distinctly composed of fibres, great difficulty is often experienced in following out the latter, from their being always flabby, and easily ruptured after death, although in a living state they are exceedingly strong. In certain muscles also they are so blended together as scarcely to be distinguished, and, in this case, may be submitted to a preparation which renders their separate fasciculi more apparent.

333. By macerating the muscles in alcohol their fibres harden and become more distinct, but also more adherent to each other, which renders the dissection very difficult; besides which the maceration must last many weeks, which is too long a time when a dissection is in hand. Another more convenient method, formerly proposed by Massa, and later still by Stenon, is to boil the muscles, and soak them afterwards for some minutes in fresh water, so that they may imbibe it. By the action of the boiling water, the cellular tissue uniting the muscular fasciculi disappears, and these be-

coming free easily separate, while at the same time their peculiar substance, fibrine, hardens, and is rendered more apparent.

Such preparations may also be employed for studying the form and disposition of the elementary muscular fibres; but simply as a guide to these inquiries, for, thus modified, they are no longer fibres in their natural condition. For this purpose, very delicate muscles must be selected to be placed under the microscope, in order to examine them in their entirety. In Man, the elevator muscle of the eye-lid can be employed; but it is better to take from animals where much finer muscles are found. Those of the belly of frogs are most frequently used, which possess the advantage, for experiment, of being very sensible to galvanic action, and admitting of the contraction of the fibres being seen.

334. Vertebrated animals having their skeleton within, and the muscles, with many other organs placed externally, it is by proceeding from without inwards that these parts should be dissected, either for taking drawings, or making anatomical preparations for preserving.

335. For the former purpose, the body is usually placed in such a position as to present that surface uppermost or in front, from which it is wished the organs to be displayed, and most frequently upon one of the sides, a profile permitting us to embrace at a single glance, the greatest number of objects, when the body is naturally flattened in a lateral direction, while it is to be placed either upon the back or belly, when its form is vertically depressed. As a general rule, it should be so placed as

to present the least possible fore-shortening, for in that position the parts do not admit of being clearly distinguished, and their dimensions and relations judged of with accuracy. On this account anatomical draughtsmen should avoid as much as possible giving figures, where there is much fore-shortening and three-quarter views of objects, such conveying always a false idea of things, though they may be excellent specimens of drawing. It is for this reason that painters of natural history make their designs geometric, and not perspective, like historical artists.

336. The animal being thus placed, so as to exhibit from above the side from which it is wished to dissect it, the integument is first raised carefully, and in strips from the parts to be examined, so as not to cut into subjacent structures.

Now, although the skin is commonly united to the body, simply by cellular tissue, this is not however the case in all animals, nor in every part. Where there exist tegumentary muscles, as in the neck and face of Man, or all around the neck and upon the flanks of Mammiferous quadrupeds, the skin is very difficult to detach from these muscles, and cannot, indeed, be removed entire where the latter are inserted. Nevertheless, it must be raised with necessary precaution against destroying these same muscles, so that their precise points of adherence may be well distinguished.

337. As a general rule, in order not to cut or *mangle* these organs, the edge of the scalpel must *never* be turned *directly* to them, for, in that case, the instrument penetrates easily; the blade, must, on the contrary, be

always held in such a manner, that in dissecting, the edge may be directed somewhat obliquely towards the muscle, except in detaching fragments, which are to be afterwards removed. In thus raising the skin, which is, besides, more resisting than the muscles, care must be taken to hold the edge of the scalpel slightly turned towards it, and to cut parallel to the fibres of the muscles under preparation. In this case, when some strokes of the knife are inadvertently given in the muscle, it is less cut, being merely divided a little more in the direction of its fibres. It is very important to follow out this precept in every kind of dissection; for to such a plan of proceeding is due in a great measure the good success of the operation.

338. The tegumentary muscles are firmly applied to the skin in their terminal portions, at the same time becoming very thin, so that it is often impossible to pursue them to their termination, and is more convenient to trace them only to the middle of their course; they are then cut across, and their terminal portions raised with the skin, against which they rest, closely applied, and by the contrast of their red colour upon its white ground, are very clearly displayed, while the other portion remaining attached to the body, may be followed out like the ordinary muscles.

339. Whatever preparation is being made, it is never advisable to suffer our movements to be hurried, or to make the least incision with the scalpel, without having well calculated the effect it will produce—for an organ once cut, cannot possibly be restored; and hence in anatomy, more than in all other kinds of research,

the precept of "*Festina lentè*" is our best and surest guide. A dissection slowly made with care and method is very preferable to many successive preparations negligently conducted, which always leave doubts as to the same objects, though seen a dozen times over; and upon reverting to which there remains, if any, but a very small number of certain facts to which our attention can be easily directed.

340. When a muscle has been well studied, and it is wished to raise it, it is cut cleanly across the middle in a transverse direction, so that the two ends may be readily brought together, if it is wanted to replace them so as to see again their points of attachment. After having thus separated them, the two ends are to be traced if possible to their insertions, so as to become acquainted with their entire course; but they are not to be cut through completely when there is no necessity, that is, not until the other muscles immediately surrounding them have been studied, for to recognize the disposition of the latter, that of the first examined muscles must often necessarily be known.

341. When many adjoining muscles closely resemble each other, as those of the fore-arm in Man, it is important not to cut them all across upon the same level, but at different heights, so that there may be no mistakes made, when it wished to replace each of their ends.

Many of the muscles, and especially those of the extremities of Vertebrated animals, are contained in aponeurotic sheaths, in which they glide more easily. These sheaths, in every respect similar to aponeuroses of in-

sersion both in use and structure, and giving often attachment also to a portion of the fibres of the muscles they enclose, are formed in many cases of fibres variously disposed, which constitute different lamellæ, sometimes adherent to each other, and often separated, in some parts to be joined to different muscles, or form partitions which penetrate between these organs.

342. After having well examined the direction of these different kinds of fibres, and recognized their relations of superposition, as well as their attachments, a layer is to be divided along the middle of the subjacent muscle, and the two halves being turned down, it is to be observed whether they are continued freely upon the other muscles, or if they form partitions, which must be traced to their attachments. For the sake of regularity, it is good to make the first incision near one of the attachments of the aponeurosis, in the direction lengthways of some bone, so as to have a very clear point of departure; and continuing afterwards to trace the lamella from one partition to another, as far as its other attachment along the bone, to disclose thus all the partitions which it forms, so as to take up afterwards each in particular.

343. It often happens, that these aponeurotic expansions become so adherent to certain muscles over which they pass, that it is impossible to separate them, and in many cases are so weak, that the attempt would be followed by their destruction; but they are still recognized by the resistance which their fibres oppose to the scalpel in scraping the surface of the muscle with the point of that instrument. Lastly, some aponeu-

roses, becoming thinner and thinner, degenerate into cellular tissue.

344. Many aponeuroses, either from representing membraniform tendons, or serving as a sheath or loop to muscles, are found in close contact, and confounded with them, thus forming often very thick membranes; but, in carefully studying their structure, the distinction between the elements of these fibrous expansions, and those of the muscles to which they belong, will always be recognized by the direction and superposition of their fibres. An example of the above is furnished in the vertebral groove of Man, and the other Mammalia. What has been just stated requires special attention; for in considering, as is generally done, the large aponeuroses simply as fibrous membranes forming single organs by themselves, no account can even be taken of their composition, which seems as if made by chance, whilst, when regarded as the juxta-position of several lamellæ, which in many points are found separated, the one set belonging to different muscles, and the other forming sheaths or bands, it will be readily understood why the fibres are observed to run in different directions.

345. The muscles forming in the Vertebrata the most considerable mass of the body, and being the most numerous organs, the study of this part of anatomy is the longest, and in certain regions, as the back, also the most difficult; but it is important that these organs should be well known, since they form the principal receptacle upon which others are placed.

346. The course to be pursued when there is only a

single individual upon which to study all the muscles, is very different from that employed when there are as many subjects as may be wished at our disposal. For zootomy the first is the most frequent case, except when a very common animal is used.

347. When, then, only one subject can be had, it is perfectly necessary to preserve it in some fluid which prevents putrefaction; for this in the long run will always take place, as, during work, the body must be kept out of fluid, and hence all necessary precautions should be taken, that putrefaction does not proceed too fast.

348. It has been already said before (§ 220), that only as much integument should be raised as is necessary to expose the part under dissection; but this becomes much more important, when the question is, how the same subject may be kept the longest possible time? When the body is very large, and there is reason to fear that the preserving fluids would not penetrate with sufficient ease into its interior, especially into the intestines, where putrefaction usually commences, a small opening must be made in the ventral parietes (§ 221), and in the chest, so that the antiseptic fluid may penetrate them, or else the whole mass of the viscera, and, above all, the intestines, must be removed. This last operation is the one most frequently had recourse to; but in performing it the membranes, fat, and all the other organs generally which do not easily corrupt, must be left as much as possible in their place, and only the intestinal canal removed; the muscles always preserving much better when covered by some other part, although that may

be but a simple and slightly adherent membrane. As it is scarcely possible to study the abdominal muscles until the anterior extremities have been detached, care must be taken not to remove the skin from the flanks; if, however, the tegumentary muscles are to be seen, their study must be first commenced, and they should be left in their places to preserve better those which are subjacent.

349. The muscles of the shoulder are in a great measure so implicated with those of the neck, and the latter again with those of the head, that it is necessary to begin with the last; and the more so, since the superficial, such as the cervico-facial and some others, are very thin and difficult to prepare upon an animal which is not fresh.

350. Our study, then, will commence in the Mammalia, with the muscles placed superficially upon one side of the head, as the cervico-facial, frontal, and occipital; the superficial muscles of the ear which are not well circumscribed, those of the eye and of the nose the least distinct of any; the superficial ones of the lips, as the zygomatic, the canine, the elevators and depressors of the lips, as well as the orbicularis, which last had, however, better not be destroyed at once, so that, later on when the buccinator is reached, it may be seen how it blends with that muscle.

351. After these, which well demand a first day's work, the subject should be put back into the fluid, and the preparation will next continue with the somewhat deeper muscles of the head, those of the external ear, the masseter, the superficial muscles attached to the os hyoides, and lastly the digastricus.

352. All these organs being removed, and the jaw entirely exposed, that part of the temporal is first studied which is inserted into the zygomatic arch, as well as the corono-malar ligament, so that this arch may be afterwards removed by cutting it through in front of the glenoid cavity, and the malar bone through its middle. The temporal fossa being thereby exposed, the different heads of the temporal muscle may be examined with care. This muscle being removed, the jaw is disarticulated, and raised with caution so as not to destroy the pterygoid muscles, as well as the hyoglossi, genioglossi, styloglossi, and genio-pharyngei, which will be thereby disclosed. No muscle should be removed, except it is in the way, but should be simply turned back, when possible, to disclose those placed beneath; the styloglossus should be cut near to its attachment to the cephalic cornu of the os hyoides, and likewise folded back, to serve as a guide when, later on, the muscles of the tongue are reached.

353. In turning back these muscles, those of the pharynx will be disclosed, the buccinator, the lateral muscles of the velum palati, as also those of the hyoides and larynx, which last had better be left in place so as to be removed *en masse* with the tongue, by cutting through the cephalic cornua of the hyoid bone at their insertion into the head, and through the trachea with the œsophagus, and the sterno-hyoid and sterno-thyroid muscles together at a certain distance above the larynx, leaving the lower part of this *in situ* between the muscles of the neck.

354. The constrictor muscles of the pharynx cannot

be so well seen in this way, especially upon their posterior surface, as by disarticulating the head, though a sufficient view may be got of them to determine the disposition of these organs, whilst, in removing the head, all the muscles which pass from the neck to it would have to be examined first, and all those which are met with upon the opposite side, which it is important to preserve for a second dissection, sacrificed.

355. After having removed all the muscles of the pharynx and hyoid bone which are attached to the head, the cephalic cornu of the hyoid bone must be cut through, to expose the muscles of the velum palati; in removing those upon the side, and especially the circumflexus, great care must be taken not to cut through the muscle of the malleus.

Having examined the lateral muscles of the velum, as well as the pharyngeal and maxillary portions of the buccinator, the two layers of the mucous membrane which forms the velum are to be separated, so as to see the muscles which penetrate betwixt them. Next, all the lateral part of the mucous membrane of the mouth and pharynx is to be raised to see the interior of these two cavities, the opposite parietes of which make us acquainted with the arches of the velum, and the relations of all the lateral parts between it and the larynx. By this last operation, all that concerns the muscles of the head, excepting those which move it upon its occipital articulation, will be finished.

356. After having removed the tongue, with the extremities of its external muscles still attached, it is to be dissected separately to see its internal muscles; but

as these are formed merely of very fine fasciculi, which interlace, and at the same time are very adherent to each other, it is very difficult to study them in the fresh state, although with some care their disposition may be recognised, and it is better therefore to submit this organ previously to some preparation, which renders its fibres more distinct; this consisting, as has been alluded to before (§ 333), in boiling the tongue for half an hour in water to dissolve the cellular tissue, and harden the muscular fibres.

357. By stripping off the skin afterwards in those Mammalia with a compressed thorax from the anterior region of the trunk, comprehended in a triangular space between the head, the middle of the back, and the scapulo-humeral articulation, all the muscles placed upon the neck and superficial part of the shoulder will be disclosed, and are to be studied in layers throughout the whole of this space, that is successively, the clavocucularis, the sterno-mastoid and cleido-mastoid in their cephalic portions; the dorso-cucularis, acromio-cucularis, rhomboideus, occipito-scapularis, and transverso-scapularis, in their posterior part; all the pectoral muscles relatively to their attachments with the trunk, and lastly, the dermo-humeral and latissimus-dorsi, which must be simply cut transversely through the middle of their length. Lastly, the serratus magnus is cut transversely by raising the shoulder blade, and studied then in its scapular portion. The whole anterior member being thus detached, it is placed in fluid to be reverted to, after having studied all the muscles of the trunk.

358. That portion of the serratus magnus which re-

mains fixed to the trunk should be exposed, and may be studied *in situ* (but it must not be raised, or even detached, so that the muscles beneath it may be kept fresh), as well as the relations of others which are attached to the transverse processes of the cervical vertebræ, the serratus magnus forming the separation between the scaleni and trachelo-mastoid muscles.

359. The anterior extremity being removed, the scaleni muscles, isoceli, external sterno-costal, small anterior serratus, and a great part of the splenius, the trachelo-mastoid and external-oblique muscles of the abdomen will be exposed. This last is forthwith to be studied, especially in its attachments to the thorax, to see how its indigitations interlace with those of the serratus magnus, but it must not be raised except to see the internal oblique. After the external oblique the two small serrati are to be prepared, and next to them the internal oblique, but this last must be left likewise in its place with the external, until the transversalis can be got at, which lies beneath, so as to examine well the abdominal aponeurosis, formed by the juxta-position of their lower tendons. After the small serrati and internal oblique of the abdomen, the transversalis and abdominal aponeurosis, as well as that of the crural arch and inguinal canal, can be examined, but the muscles of the thigh often prevent us from following out the latter, and it is better to wait till part of them have been removed. If, however, this inconvenience does not occur, it is better to proceed at once with the dissection of all the abdominal muscles, the recti being of course included.

360. After these, the external intercostals will be exposed for study, but not for removal, and the preparation of the superficial muscles of the neck, as the splenius, intersectus, complexus, and trachelo-mastoideus, taken in succession, but only as regards their cephalic part, without removing them at their vertebral attachments, so as to preserve their relations with the muscles of the spine.

361. Under the small serrati is found the third layer of the superficial spinal aponeurosis, those of the latissimus dorsi and small serrati forming the first two. This expansion being slit along its anterior part exposes the muscles of the spine, and allows us, by separating the latter, to follow to their posterior attachments the splenii, intersecti, complexi, and trachelo-mastoidei muscles.

362. Before engaging with the dissection of the muscles of the vertebral groove, the scaleni and isoceli must be examined without disarranging at all the anterior muscles of the neck, passing next to the spinal muscles, commencing with the epicostales, the costo-lumbares, and lumbo-spinales (sacro-lumbares of authors), then in succession to the muscles composing the longissimus dorsi in Man, in other words, the costo-spinales, transversales obliqui as far as the pelvis, the superior lumbo-transversales, and the lateral lumbo-transversales, the deep spinal aponeurosis, the obliqui spinales as far as the pelvis, the inter-obliqui, the spinales of the back, the inter-spinales, and the ligaments of the same name; but these last should be left in place to preserve the indication of the middle line of the back, so that their

disposition may be better recognized, after having removed also all the spinal muscles of the opposite side.

363. All the muscles of the vertebral groove being removed, the preparation of the internal intercostal and surcostal muscles is proceeded with; then the thorax is opened by separating the ribs from their cartilages upon one side, or better still, if it is not wished to preserve the skeleton, by cutting the ribs through their middle, as far as the last true rib; and the sternum is simply folded back with its costal cartilages towards the opposite side, so as to see from within the internal sterno-costal (*triangularis sterni*); lastly, the opposite ribs are cut across also, then the internal sterno-costal, between the two last attachments of the true ribs, leaving the last of these and the false ribs in place, to serve as a frame of suspension to the diaphragm, which will be thereby seen very well from its two surfaces.

364. If, however, it is wished to preserve in its entirety the whole opposite side of the animal, to serve the purpose of a second dissection, the ribs of the side to be operated upon are alone cut across, to see the internal sterno-costal muscle; and then, after having examined successively the ligaments of all the ribs, commencing with the first, the bones are disarticulated to open the thorax entirely. The diaphragm can here also be very well studied.

365. All these preparations having been made, the cervical muscles, in other words, the motor muscles of the head, and those of the vertebræ of the neck, as also the ligaments of the same parts, which have not been yet examined, are to be taken up; and the inferior

longus colli, which penetrates into the thorax, may be studied with great facility.

366. After having removed the diaphragm and the ribs which have been left in place, all the sub-vertebral lumbar muscles will be exposed, the two psoades, and the long sub-intertransversales of the loins, with their corresponding vertebral ligaments.

367. All this being done, the muscles of the posterior extremities, which remain covered with their integument up to the anterior border of the pelvis, will alone occupy our attention. Particular notice must be taken of the sacral aponeurosis, and the crural, which is a continuation of it, to endeavour to distinguish well the different lamellæ of the first, so as to see how they are continuous with those of the superficial spinal aponeurosis of the loins; and among others, to form a clear and just idea of the attachments which they furnish to the different crural muscles. The posterior limb is then proceeded with by layers, the first formed only by the sartorius, fascialis, and biceps muscles, which terminate by aponeuroses fixed to the leg; and the last, which prolongs itself often by its aponeurosis as far as the heel, should be traced thither, studying at the same time the superficial aponeurosis of the leg, in which these three muscles are partly lost.

368. All the muscles placed upon the pelvis and the thigh being well studied, are to be cut, either across their middle, or through their tendons, which is still more convenient, and the thigh removed by disarticulating it from the acetabulum. The muscles coming from the sacrum and the tail are cut as far as possible

from their origin, so as to serve as guides for the muscles of these two regions, the preparation of which may be now proceeded with, resuming, however, in succession the continuation of the muscles of the lumbar region, which has been interrupted in front of the pelvis.

369. In order not to get the numerous muscles of the tail into confusion, the greatest order must be observed ; commencing by a superior lateral series (very distinct), such as the transversales obliqui, and continuing afterwards by parallel and successive series. These series of muscles, being nearly all enclosed in special fibrous sheaths, the latter must be opened successively. When the muscles, contained in one of these sheaths, have been studied in their minutest details, they are to be removed entirely, so as not to be confounded with others, and then another sheath placed at its side is opened singly, and thus in due order to the inferior median line, taking up afterwards those muscles placed in the most internal part of the superior region.

The caudal muscles, varying often in the same series, most frequently losing successively from before backwards their longest heads, must, to be well understood, be all passed over in review and in succession, with the greatest order, taking them up one after the other, from before backwards.

370. After having seen all the muscles of the trunk, those of the extremities may next be passed to, or those of the trunk on the opposite side, which will constitute a second dissection, which it is essential to make as soon as possible to verify what remains doubtful, while

all is still fresh in the memory. This dissection is proceeded with precisely as the first.

371. The muscles of the limbs are to be taken successively in layers, and from the same surface as far as the bones, and then the others upon the opposite side. But particular attention must be directed to the aponeuroses which form partitions between the muscles, and not only separate them, but furnish numerous points of attachment which are necessary to be known. These muscles must, consequently, be studied in a regular order, and no new sheath be opened until the muscles have been either turned back or removed from that which has been opened before.

372. PRESERVATION.—Preparations of the muscles are preserved in a dry state, or in fluid. The first method is the least expensive, but these organs in drying harden to such a degree, as completely to lose their form, while at the same time the preparations become very unsightly, spread a very foul odour, are difficult to make, and can serve but little for demonstration. The muscles had better, therefore, be preserved in fluid, but it is as well to point out the methods employed for making these dry preparations.

A subject is selected, which has not died from a lingering disease, by which the muscles have diminished sensibly in volume, and lost their firmness. Such a subject, of a robust height, and as is said, well *muscled*, ought to be rather lean than fat, and a little beyond adult age. If it is wished to preserve only the muscles, the bones and the ligaments, the subject is merely injected with a saturated aqueous solution of alum, or

acetate of alum, or of corrosive sublimate, which is forced for this purpose into all the vessels, from the hands, the feet, and the neck, by the process pointed out in the chapter upon the organs of circulation. This injection being made, the body is left at rest some days, to allow the salt employed time to insinuate itself into all the small vessels, when the dissection is proceeded with. The preparation being so far done, the muscles are to be separated slightly one from the other, by placing between them different bodies which will keep them best in position, as cards, bits of wood or cork, tow, &c. ; but care must be taken to grease these bodies previously, so that they may not stick to the muscles. Whatever arrangement is intended, is given to the latter, and the specimen left to dry in the air.

373. Although the preserving fluids injected resist putrefaction very well, it is more convenient to make these preparations during the cold season, or, at least, not in the middle of summer. But by this process the grease is not altered—it becomes oily, rancid, and stinking, and soils very much the preparations. It is, therefore, better to remove as much as possible of it, by impregnating the parts with some strong ley, which, combining with the grease, converts it into soap, and renders it capable of drying; still it is a matter of great difficulty to dry these preparations entirely.

374. Another inconvenience when the corrosive sublimate is employed, is that this salt powerfully attacks our iron and steel instruments, while, at the same time, it is a very dangerous substance to meddle with, and it is infinitely better to make use of the sulphate of alum,

which has been employed for a long time to preserve muscles with; and in fact, when these organs have remained for some time in this fluid, they can be dried and perfectly preserved. This fluid having besides the advantage of saponifying the grease, and leaving its colour white, the preparations made with it are not so soiled, but are like all others, dry, brown, and horny. Once dried, they are washed with a solution of corrosive sublimate, to preserve them from insects.

The best methods of preserving the muscles of Mammalia, is to keep them either in a solution of sulphate of zinc, pointed out in the first part of this work, or dry, with camphor in an hermetically sealed jar, which prevents the production of mould, so long as it remains unabsorbed.

AVES.

375. DISSECTION AND PRESERVATION.—The muscles of Birds are prepared by the same methods as those of Mammalia; only the animal must be first shaved, by cutting off all its feathers nearly upon a level with the skin, excepting the large feathers of the wings, and those of the tail, which are to be cut off shorter.

The skin is to be removed in small portions, and with the greatest care, to see how the fasciculi of the panniculus-carnosus are fixed into the feathers, and determine the manner in which all these little muscular bundles are re-united to form the different sub-cutaneous muscles of the body. Where, however, the skin can be left in its place it should be carefully preserved, to pre-

vent the too rapid alteration of the muscles placed beneath.

As to the means of preserving the preparations, they are absolutely the same as for the Mammalia.

REPTILIA.

376. DISSECTION AND PRESERVATION.—The muscles of the Saurians and Ophidians are prepared in the same manner as those of the Mammalia. As many of these organs are attached to scales, care must be taken not to injure them; and with this view, the skin must be incised along the back, and the edges turned down upon the sides, lifting them up one after the other with care. When a muscle is discovered, which passes from the bones to the scales, it is cut neatly across at a little distance from the latter, but in such a manner, that the two ends should be as little as possible detached from the part to which they remain fixed, so as to be found in place when they are examined. The other muscles are prepared in the ordinary way.

377. Nothing is easier than to make preparations of the muscles in the Anoura, where the integument is entirely detached from the body, and has no hold except around the mouth, eyes, anus, and by some tegumentary muscles, the body being as it were thus naturally flayed beneath the skin. To remove the skin, a small incision has only to be made in the back, the opening enlarged, and all the integument removed without at all disarranging the muscles; under the chest and in the axillæ are found the tegumentary muscles, which will be cut into with due precaution.

Preparations of the muscles of Reptiles are preserved like those of Mammalia.

CHELONIA.

378. DISSECTION AND PRESERVATION.—To make preparations of the muscles of the trunk in the Chelonia, the best plan would be to open the carapax from the side, and in the middle of its length, by making at first two transverse and parallel cuts with a saw, intercepting an equal space about the sixth of its entire length and in the middle of the interval of the two apertures. These strokes of the saw are to be prolonged from the plastron to a little above the middle of the carapax, and the intersected piece removed, but care must be taken not to penetrate with the instrument too far into the cavity of the body. Through this aperture, effected in a space comprised between the serratus magnus and the abdominal muscles, and where there are no muscles, the finger may be introduced to explore the parts, and ascertain to what extent it will be possible to enlarge the aperture without injuring them. This enlargement is made by means of the osteotome (§ 70); the blade of a scalpel is introduced, to detach all around the muscles which are fixed to the ribs, and the latter are removed by degrees, as the muscles have been detached. In proceeding thus, step by step, the lateral half of the carapax will be detached and removed, by which an internal profile is obtained, and the actual dissection proceeded with afterwards by the ordinary methods.

379. The half of the plastron may also be removed

at first from the side of the animal, by sawing that longitudinally in its straightest part, between the two anterior and posterior apertures, but nearest to the plastron. A second stroke of the saw may be made longitudinally in the median line of the plastron, which will thus admit of the detached half being lifted up. The integument may afterwards be cut from the anterior and posterior border of this half of the sternum, close to the bone, and gliding the blade of the scalpel flat upon the plastron the adjoining attachments of muscles will be divided. Lifting up afterwards the plastron from the side, the lateral edge of the instrument is glided under it in the same manner, to detach the muscles fixed to the plastron, towards the middle of the body; in other words, the pectorals attached in the anterior half of the plastron towards its internal surface. The attachments of these muscles are limited in *Testudo Europæa*, to the arc of a circle, the centre of which is at the anterior extremity of the lateral line of the saw, and the curve of which passes near the median line of the plastron; from the anterior extremity of the latter, the acromion and deltoid muscle will be detached with ease, and the aponeurotic attachments of the transverse abdominal muscle will be cut towards the sides, in the middle of the plastron. In the posterior half, the rectus muscle of the abdomen will be detached, which is fixed nearly along the median line, and the half of the plastron then removed. The rest of the proceedings are the same as for Reptiles and Mammalia.

380. The corresponding half of the carapax can afterwards be easily removed, by sawing it longitudinally at

a small distance from the median line, so as not to damage the muscles which are attached there, or else the other half of the plastron, if it is wished to open the animal entirely from below.

Preparations are preserved like those of the other Vertebrata.

PISCES.

381. DISSECTION AND PRESERVATION.—The body of *Fishes* being generally compressed, it is most convenient to dissect their muscles from the side, so as to avoid having them foreshortened. For that purpose the integument is removed in strips, taking care not to cut into the muscles, so that their tendinous partitions may remain very distinct. Upon the animal thus flayed the latter present themselves under the form of numerous raphè, giving insertion to muscular fibres, all of them longitudinal. To recognize the disposition of all these muscles, confounded together, transverse sections of the whole body may be made at different points, wherever it is judged most suitable, but chiefly at a small distance behind the pectorals, at about the middle of the visceral cavity, and towards the base of the tail, as perpendicularly as possible to its axis, so that the muscles of both sides may be cut upon the same level. The rows of muscles being thus divided across, not only is the space they occupy perceived, but also their relations either with the vertebræ, the apophyses of these bones, or the ribs. It is also seen how the fibrous partitions are continuous one with the other, and how they are fixed to the skeleton. All the muscles of one and

the same series being nearly in the same condition, the manner in which they are enveloped can be judged of, and their arrangement better understood; on the one hand, the raphès indicate the direction of the muscles, and, on the other, the modifications which each series experience, are displayed in the different transverse sections made. By these same sections it is seen also, at a first glance, to what depth each series of muscles goes, and how their mass may be removed to expose one or many other series. Lastly, the number of apophyses or ribs, which have been cut from the vertebra to the integument, shows how many vertebral or costal spaces each simple muscle bounds from the point of insertion of its aponeurosis of origin, as far as the integument, where it terminates.

As to the isolated muscles of the trunk, it is better to study them in each section which has been made, by examining its surface. The muscles of the head, branchiæ, and pairs of fins, few in number and more or less distinct, are prepared as in other Vertebrata.

As regards the preservation of preparations of the muscles, the same means are employed as for those of other Vertebrata.

SECT. II.—ARTICULATA.—ANNELIDA.

382. DISSECTION AND PRESERVATION.—To see the muscles of the Annelida, the body should be opened along the back, where there are the fewest of these organs; but as these animals contract when placed in any irri-

tating fluid to kill them, which renders their body shapeless, it is advisable to drown them in slightly warm water; they then lengthen out by creeping at the bottom of the vessel, become exhausted, and soon die in a state of extension. They are to be fixed for dissection with pins upon flat pieces of cork, and after having been opened in the whole length of the back, the edges of the slit are to be turned down upon either side. In opening the body from the sides, the muscles of the extremities will be all seen foreshortened.

These preparations are preserved in fluid.

MYRIAPODA.

383. DISSECTION AND PRESERVATION. — Although the Myriapoda have a vermiform body, it is much more convenient to open it from the side to see their muscles, than from the back or belly; for by the two last methods a number of muscles which pass from below upwards are cut across, while from the side none are injured; in other words, the body must be opened by incising it along the middle, as will be pointed out in the directions upon the subject in Insects (§ 385). By this plan, an internal profile, viewed from the median plane, is obtained, and though the body of these animals is often slightly depressed, the lateral half does not present so deep a cavity but that all the organs can be easily seen.

384. The segments being ordinarily very moveable upon each other, the muscles would be readily torn, if the body were cut in two throughout its entire length

without great precaution, and the more because the segments when divided become still more moveable, so that it would be almost impossible to make a tolerable preparation for examining or studying any part, all being more or less injured.

The only method to be employed to guard against these inconveniences, is to use anatomical moulds, of which a description has been given before (§ 52). For this purpose, a subject must be chosen which has not remained too long in fluid, or the flesh of which, at least, is not softened, but especially one that has not been folded and unfolded, which necessarily tears the muscles; it is to be laid by its lateral half in very fine plaster, and as the body is generally deprived of hairs, which could otherwise lay hold on the plaster and serve to maintain the segments in place, a little crooked pin must be planted in the free part of each ring. The body being held by one half in plaster, the free half is cut away to the median line, by removing it in small portions, and then proceeding for the rest as in Insects.

The head being depressed, the muscles are shown foreshortened when it is opened from the side; it must be, therefore, dissected by opening it from above, or below. For the preparations of the manducatory organs, see the directions relating to the digestive apparatus of the Myriapoda.

The preparations are preserved in fluid.

INSECTA.

385. DISSECTION AND PRESERVATION.—The muscles of Insects being generally softer in the fresh state than

those of the Vertebrata, and hence more difficult to distinguish and dissect, the body of these animals should be macerated previously for some days in weak alcohol (¶ 113), such as is used for preserving anatomical preparations, so as to slightly harden these organs, and render them more easy to dissect. When, however, these animals have remained a long time in this fluid, the muscles harden, and detach so cleanly from their insertions into the integument, that great difficulty is experienced in cutting without displacing them. This solution of continuity has of course the disadvantage of not allowing us to assure ourselves of the points of attachment of these organs, which are, however, often recognizable by their impressions upon the integument, and by proceeding with care individuals thus altered may be used; in this case the muscles will not require to be cut from their attachments, and as they are fixed to circumjacent parts by the slight bands furnished by the tracheæ, they are maintained sufficiently well in place, not too liable to disarrangement, and their relations can be as well studied as in fresh subjects; if it is wished to remove them in the latter, their tendons may be cut with the microtome.

Most of the muscles of Insects being so disposed, that they present less foreshortening when seen in profile, than from above or below, their arrangement is better learnt by preparing them from the sides, commencing for that purpose with the layer forming the median plane, or internal profile, where these organs are ordinarily exhibited entire, which would not take place if the sub-cutaneous layer was begun with. In certain cases, however, this last process is employed in

preference, for example, for the feet, which have not symmetrical parts, or even for the head, which being most frequently depressed, has its muscles and other organs placed so as to be seen foreshortened from the side. It is better, therefore, to dissect these last parts by the superior aspect, but as a general rule, the body must be opened from the side, where the organs are seen least foreshortened.

386. For his principal preparations M. Straus-Durckheim always employs the right half of the body, so as to have the head of the animal to the left. This is not rigorously necessary, but by studying things constantly from the same side, the analogies which exist between them are more easily recognized, and the modifications of detail better appreciated. Although this appears at the first a very minute and useless care, the advantage of it will be soon seen by the difficulty which is experienced in recognizing their identity, when an animal is all at once examined in a reversed position. Also as a facility to those who would wish to study the objects from figures, they should always be placed in the same position, and as much as possible in the same order.

To make the preparation of the internal profile of an insect, the body is cut into two parts with the slice (¶ 73), care being taken to leave that of the right larger than the left, so as not to injure the organs placed in the median line.

This operation is easily done upon Insects whose integuments are not very hard, but in regard to the Coleoptera it must be effected with caution.

The half to be preserved is afterwards fixed upon a

plate of cork, without planting the pins, if avoidable, in the interior of the preparation, and then placed in a basin of water. All that which belongs to the half of the body to be sacrificed is removed first by bits, approaching thus, little by little, the median line, the greatest care being always taken not to move about too much the half it is wished to preserve, lest it should disunite the organs therein met with. On arriving near the median plane, great attention must be paid not to cut into the azygos objects found there. The specimen being thus prepared for actual dissection, the water in which it is immersed detaches all the fragments of the destroyed organs, and these are removed carefully, either with the forceps, with curved needles, or a brush; lastly, for the smallest portions, by simply agitating the water by blowing on it from above.

For the accomplishment of the actual dissection, precisely the same method of proceeding is employed as for the Vertebrata, with this difference only, that from the minuteness of the objects, very fine instruments must, of course, be used, not only the smallest sized scalpels, but more frequently curved needles (§ 76) and the microtome (§ 72.) Proceeding thus by layers, the last or most lateral is arrived at.

387. When the body of the animal is soft, or even where its integument, although solid, is formed of pieces very moveable one upon the other, and easily displaced when the animal is slit in two, use should be made of the anatomical moulds (§ 52) for sustaining the parts.

The body being held in the plaster by the half it is

wished to preserve, the plaster is first to be cut to give it a plane or slightly convex surface above, surpassing rather the median plane of the body, which is afterwards cut with the *slice* or the scissars upon a level with the plaster, this serving as a guide while the animal is being divided. Afterwards cutting the mould a second time to the *real* level of the median plane of the body, a level is obtained, which serves as a base for taking a number of relative measures.

388. To prepare specimens for dissection by the sub-cutaneous plane of the muscles, the integument must be cut with the greatest care by gliding the slice nearly flat from above, so as to remove just the thickness of the latter, and the incision should be made in the course of direction of the muscular fibres attached to the integument. Care must also be taken not to saw too much, so as to tear the sub-cutaneous muscles.

389. The different joints of the feet, those of the antennæ and palpi being generally very small, are very difficult to be held to be opened with the *slice*. For this purpose M. Straus-Durckheim presses the piece along its length in a morsel of wax, where it is at once retained by the projections of the mould, and the adhesive nature of this substance. If this does not suffice, he fixes it with a little gum upon a solid body, and at other times, is content with simply supporting it between the fingers.

390. Preparations of the muscles of Insects ought, necessarily, to be preserved in fluid, and, as much as possible, in a dark place, these organs speedily becoming black when exposed to light and soon deteriorating.

For the preparation of the masticatory organs, see the directions relative to the digestive apparatus of Myriapods and Insects.

CRUSTACEA.

391. DISSECTION AND PRESERVATION.—To make preparations of the muscles of the Crustacea, subjects must be selected which are not too near their moulting period, since these organs, as well as the new integument to which they are attached, and which is still membranous, then separate with the slightest force from the old ones about to be abandoned.

They are dissected, as in Insects, by the internal profile, except where a particular case demands otherwise; but as the shell is most frequently very hard, so that it would be impossible to cut it with the slice, ordinary scissars must be employed for the small species, and even the bone-nippers (§ 70) for the large; care being especially taken not to establish the first cut very near the median plane of the body, for fear of damaging the organs found there, and particularly the gizzard, which is set in motion by several muscles. It will be even best entirely to sacrifice one-half of the body, to avoid injuring the other. The longitudinal incision being made, the specimen is to be fixed upon a plate of cork, and the dissection, which ought to be always conducted under water, proceeded with in the ordinary methods.

392. Many small aquatic species, as the *Daphnides Argulus*, &c., have the body so transparent, that their

internal organs are sufficiently well seen through their integument, and the disposition of many of the muscles can be thus studied upon the living creature, without dissection. In this way the motor muscles of the eyes in *Daphnia*, a genus of small Branchiopods, about a line in length, may be perfectly well seen under the microscope.

393. Preparations of the muscles of Crustacea should be preserved in fluid; but this should not be acid, for fear of softening the parts of the shell to which muscles are attached.

CIRRHIPEDA.

394. DISSECTION AND PRESERVATION.—To make preparations of the muscles of these animals, and of all their other organs, one of the valves must be first removed; the other is fixed upon a plate of cork by means of hooks (§ 63), and the actual dissection proceeded with afterwards by the ordinary methods. The two valves may also be removed at once, if it is wished to illuminate the body from below.

ARACHNIDA.

395. DISSECTION AND PRESERVATION.—The muscles of the Arachnida being mostly vertically disposed, it is especially necessary to dissect them by the internal profile of the body (§ 386); but it becomes very difficult to make the first longitudinal incision well, seeing that not only the buckler, the external sternum, and the feet are extremely moveable and easily displaced (which causes numerous ruptures of the muscles), but the carti-

laminous sternum being more solid than the other, prevents this cut being easily made. Sometimes, however, owing to the rarity of the subject, this must at least be partly attempted, usually upon the side not preserved, in order to verify particular facts.

When the desired number of subjects is possessed, and there is no occasion for any make-shifts, the preparation may be made upon one of the lateral halves of the body, sacrificing the other entirely; and then it is commenced by fixing the subject by the side upon a plate of cork, after having cut off, as near as possible to the body, all the legs of the same side, leaving only their very short stumps. This precaution is taken, lest these extremities, acting as levers, should destroy the internal muscles by their movements. The body being fixed upon the plate, all the parts to be sacrificed are cut into little pieces, commencing with the legs, and going by degrees towards the centre, taking care not to touch an inner cartilaginous plate or sternum, met with in the Pulmonaria, to which the muscles are attached. This being entirely exposed, and making a projection upon the half of the body which it is wished to preserve, it is cut at a single stroke, longitudinally, along the median line, either with the slice or the scissars, supporting it with the forceps, and a perfectly neat section of the body is thus obtained.

If, on the contrary, it is wished also to dissect to some extent the side removed, the longitudinal cut is made in two or four places. By the first cut the external sternum is cleft, without thrusting the slice in further; this piece is ordinarily very thin; by the second,

the labrum is slit between the two mandibles and the jaws; by the third, the buckler; and, lastly, by plunging the blade of the slice more deeply in the last two cuts, the cartilaginous sternum is cleft at a single cut, and the trunk falls into two pieces. But in doing all this much address is required.

396. It is principally in making preparations of the muscles of the trunk in the Araneida, that use is made of anatomical moulds (§ 52), the pieces of this part disjoining easily, especially when cut in two, and hence the risk is run of destroying every thing, if there are no means found of retaining them in place. For that purpose, the right legs are cut to half their length, taking care not to move them. The half of the body to be preserved is afterwards clothed by a brush with plaster, mixed very thin, so as to make it penetrate into all the interstices, and especially between the hairs, if present; it is then deposited, on its side, in plaster of the consistence of cream, and proceeded with for the rest, as is pointed out in treating upon the muscles of the Myriapoda (§ 383).

These preparations are preserved like those of Insects.

SECT. III.—MOLLUSCA.—CEPHALOPODA.

397. DISSECTION AND PRESERVATION.—To see the muscles of the interior of the sac of the Cephalopods, and especially of the *Octopus*, *Sepia*, and *Loligo*, the sac must be slit along its anterior surface, starting from the

opening, but a little to the side of the median line, in order not to injure the partition which divides the superior part of the sac, longitudinally into two lateral halves. A second cut may afterwards be made upon the other side of this partition, so as to open the two cavities. In this way a narrow strip of the sac will be left between the two incisions, to which the septum is fixed, and which serves to retain it, when it is wished to see its arrangement; but care must be taken not to plunge the scalpel too deep, so as not to open any of the visceral cavities placed along the body and formed by very feeble membranes, especially the uppermost one, situated at the bottom of the sac, where the partition is very narrow, and the walls of the sac consequently very close upon this cavity.

398. The sac being opened, the funnel is slit also throughout its length, and after having examined the orifice of the anus, a ligature is next placed upon it to prevent the escape of the ink, which would blacken the preparation. It is perhaps useless to mention, that care must be taken not to compress the body of the animal by handling it too forcibly, for fear this ink should be made to trickle out, before a ligature has been put upon its excretory canal. The purse containing the ink being placed in the *Octopus* below the branchiæ, on the anterior surface of the body, and beneath a very feeble integument, care must be taken not to open it inadvertently in dissecting other parts.

399. The lateral portions of the sac are turned back upon a plate of cork, where they are fixed with pins, and the principal muscles, as well as all the parts con-

tained in the sac, are perfectly seen. As to the muscles of the head and feet, they may be examined in different aspects upon each.

The direction of the fibres being often very difficult to recognize in individuals perfectly fresh, they should be examined in those which have remained some time in weak alcohol, where they are firmer and more apparent.

GASTEROPODA.

400. DISSECTION AND PRESERVATION.—Preparations of the muscles of the envelope of the Gasteropods are limited in a great measure to dissections of its tissue, and their study may be facilitated, by soaking the animals some days in weak alcohol. As to the preparation of the special muscles, it is sufficient, in order to disclose the muscular mass of the pharynx, to open the anterior part of the body along the median line and turn back the edges of the slit upon the sides, fixing them to a cork plate with pins, and then the muscles which compose it are detached in sufficient numbers by separating them in layers, which is easy in spite of the smallness of the objects.

As regards the other special muscles, such as those which draw the head under the mantle, or into the interior of the shell in the Pectinibranchiata, and the Pulmonea, the whole external part of the shell must first be removed bit by bit, excepting the apex of the spire to which the muscles are not prolonged; and the concealed or columellar part which will serve as a support to the spiral shell, merely left inferiorly. The body is after-

wards opened from above, from the head to the anterior border of the herniary sac, and the slit is continued along the middle of the spiral turns of the latter to the summit of the shell, traversing the respiratory cavity, which occupies the anterior and superior half of the last whorl of the spire.

The body being thus opened, the lips of the incision are turned back, and cut upon a level with the borders of the columella; lifting up afterwards the viscera, and better still *removing* them with precaution, the retractor muscles of the body are found applied against the columella.

401. To make preparations of the muscles of the Gasteropoda Pectinibranchiata and Pulmonea, and in general, to prepare every other internal organ of these animals, uncontracted individuals must, as much as possible, be made use of, for in those which have drawn back into themselves, and are hid within their shells, every thing is found so reversed, that it is difficult to recognize the normal position of the organs. As to the Gasteropoda Pulmonea, it is easy enough to get them well extended, since it is sufficient to make them perish from asphyxia, by holding them some time submerged in slightly warm water, that has been previously well boiled so as to free it from the air it contains. They soon issue from their shells to seek the respirable element, stretch themselves out, and gradually enfeebled without experiencing that irritation which causes them to contract, soon perish, remaining extended, but they must not be placed afterwards in a caustic or irritant fluid, for they would still contract by the effect of their great irritability. M.

Straus-Durckheim advises leaving them many hours in the water in which they died, and to put them afterwards in a very feeble preserving fluid, which is to be by degrees rendered more concentrated. As to the aquatic Gasteropods with a spiral shell, as the Pectinibranchiata, the same method cannot be employed, and he has never succeeded in making them stretch out.

ACEPHALA.

402. DISSECTION AND PRESERVATION.—To prepare the muscles of the Acephala Ostracodermata, and in general, all their other systems of organs, one of the two valves must be cautiously raised, without injuring the body. If the individual is still living, it so closes its valves on the least touch, that it is impossible to attempt anything upon it without forcing open the valves by violence, and then they break if not very strong, and either their pieces lacerate the body, or the instrument, which is introduced to cut the closing muscles, destroys every thing. In the dead animal, on the contrary, where these muscles are relaxed, the ligament overcomes them, separates the valves, if possible, and nothing then is easier than to remove one without disarranging the rest. When a living animal is to be operated upon, it is put for some minutes in alcohol, or even in water, which is slowly heated; so soon as it arrives at a slightly elevated temperature, the creature perishes, and this is known by the separation of the valves. It is then taken out at once, lest it should harden by the heat; those plunged even in weak spirits of wine, also perish very

quickly. The valves now gaping open, the blade of a rather blunt scalpel, or better still a scraper, is introduced; every thing is first detached from around the border of the mantle, which is not very broad: then the muscular cushion is detached, by gliding the instrument flat against the valve; and, lastly, operating in the same manner, the *closing* muscles are also cut very near to their attachments. The valves then actually separate of themselves, and there is nothing to do but detach the central part of the mantle, which adheres very slightly, but with precaution, so as not to tear it. All these operations being effected, the valve still holds on by the elevator, pretractor, and retractor muscles of the body, which must be detached cautiously, being placed quite at the bottom, where there is a risk of the liver, the branchiæ, and especially the heart, being torn. Lastly, the ligament is cut, and the valve in which the animal remains is fixed upon a cork plate, by means of three or four braces (§ 62) planted round it. In examining the valve which has been detached, the impressions of the muscles which were inserted into it are often very well seen, and may be used not only as a guide in our researches upon the small muscles, but also for taking measurements, so as to replace the muscles in case they have been disarranged; but these impressions are not perceived in the shells of all species.

403. After having examined the mantle in all its details it is cut near to its insertion, leaving, however, a part of it, that it may be recognized later on, and not confounded with any other membrane peculiar to the body.

The dissection is then proceeded with as in the other Mollusca.

As to preservation, the animal may as well be left attached to the shell in which it has been prepared; but the preparation must not be kept in an acid fluid, which would destroy the shell.

404. To prepare the muscles of *Ascidia*, belonging to the order Tunicata, the external sac must be opened along the middle of one of its surfaces, lifting up the integument, so as not to wound the body, properly so called, placed in its interior. A slit must be made at first in its whole length, and afterwards three or four transverse ones crossing it, so that the strips thus formed may be turned back, and by opening the sac thus extensively the body is exposed. After having examined the tissue of the external envelope in the different strips removed, the arrangement of the superficial muscular fibres of the body itself is to be studied; and having removed likewise this first layer of muscles from one side only, the second is found beneath it, which is seen better on the opposite side from the internal surface, after having removed the mucous membrane and the branchial laminae which cover the walls of the respiratory cavity, and deeper still, the intestinal canal lodged in the right wall.

~~~~~

SECT. IV.—*RADIATA*.

405. DISSECTION AND PRESERVATION.—To see the muscles of *Holothuria* the body must be opened along its

inferior surface, and the two edges of the slit laid back by fixing the animal upon a plate of cork; in this manner the tegumentary muscles and those of the cloaca are very well perceived.

406. The Echini ought, on the contrary, to be sawn across at equal distances from the poles of their shell, without pushing in the saw too far. If, at the same time, it is wished to see the intestinal canal turning in a spiral within the cavity, the viscera are to be removed, and in the middle of the inferior piece is found the lantern with the muscles and ligaments uniting the masticatory organs.

407. The body of the Asteriadae is opened by cutting it entirely in a horizontal direction into two halves, so as to have in a single piece all the superior part where the longitudinal muscles are situated. But it can also be opened by the method indicated in speaking of their digestive apparatus.

By either method the vesicles of the small feet placed on each side of the series of vertebræ are found. For these feet see the chapter upon the circulatory system.

## CHAPTER VII.

## NUTRITIVE SYSTEM.

SECT. I.—*VERTEBRATA*.—*MAMMALIA*.

408. **DISSECTION.**—The digestive apparatus and its appendages being like most of the other viscera almost entirely isolated, and very distinct from each other, require but little preparation, as they are sufficiently exposed by simply opening their containing cavity, to enable us to examine their general conformation and structure; so that this part of the organization of animals (next to osteology) is the most easily studied and the best known. From this peculiar disposition of the principal viscera, there is little to say about the process of dissecting them, and that little merely as to the general methods.

409. The first part of the alimentary canal or *buccal* cavity is still, however, rather a difficult study in the *Vertebrata*, on account of the large number of different organs situated there, such as bones, muscles, vessels, glands, excretory ducts, nerves, and membranes.

For the bones, muscles, and vessels, reference must be made to those systems of organs to which they belong. The glands and their excretory ducts are to be studied as will be indicated hereafter, in treating of the



glandular organs. With regard to the nerves, particular attention should be paid to them, so as to try to distinguish those which preside simply over the vitality and motion of the buccal organs, from those which minister to the sense of taste. The nerves must be followed with the greatest care from their points of issue from the cranium to their termination, especially those directed towards the coats of the tongue, of the cheeks, of the palate and of the anterior surface of the velum ; for it is certain that the sense of taste resides in all these organs collectively, though chiefly in the tongue, palate, and velum ; the principal object should therefore be to discover which are the branches that terminate in the papillæ of the tongue.

410. Some difficulty will be experienced in distinguishing the various parts of the *pharynx*, which is still more complicated on account of the great number of muscles attached to it. To see it the head must be previously separated from the trunk, in the following manner :—Cut first across the middle of the œsophagus and trachea, as well as the muscles attached to them ; remove the upper part of the cervical muscles, and then disarticulate the head, which will be thus separated with the pharynx and the commencement of the œsophagus attached to it. The arrangement of the superior constrictor muscles, as well as all the buccal muscles, the hyoideans and laryngeals, may be then very well seen.

411. As the pharynx and œsophagus collapse, having no support in themselves, it is convenient to dilate them gently by filling them with some fibrous substance, which may be introduced either by the mouth

or by the œsophagus : hair is the best thing that can be used, its elasticity enabling it to retain the walls in their natural positions. The muscles and tunics of these two parts may be dissected by removing them in layers. The epithelium alone is rather difficult to be well seen, it being but a very thin pellicle, but it becomes detached by maceration, or by the action of boiling water.

412. To understand the relations of the terminal portion of the alimentary canal, forming the *intestines*, properly so called, they must be examined first *in situ*, to be certain of their arrangement, their points of attachment, and especially their mode of suspension by means of the mesenteries ; the whole mass may be then removed at once, in order to study the parts in detail, and more conveniently ; but care must first be taken to place a ligature above and below that part of the canal which is to be cut through, to prevent the escape of fœcal matter.

413. If it is only desired to ascertain the form of the canal, and the nature of the tunics of which it is composed, it is useless to inject it previously ; but if it is wished at the same time to see the arrangement of its vessels, they must be injected by the process indicated in the chapter on the circulatory system.

The mass of intestines thus extracted from the body is to be placed on a table, and there, by pressing the canal gently between the fingers, going gradually from the œsophagus to the rectum, the contents are made to flow in the same direction, so as to be let out there. When the greater part is removed, tepid water must be poured in by the œsophagus, and made to flow out at

the other extremity, so as well to wash out the interior, and this must be continued until the water is no longer discoloured.

414. The canal being properly prepared in the interior, its walls are to be slightly distended by blowing into it, so that its form and capacity may be better understood. In this state it is easy to see the distribution of the vessels when they have been injected, as also that of the nerves.

In successively stripping off from various parts the different coats of which they are formed, to study their structure, great care must be taken not to pierce the innermost layer, so as to let out the air; but their structure may be seen still better by spreading fragments on plates of cork, and dissecting them under water.

415. To measure the absolute length of the intestinal canal, the mesenteries, which strongly bind its parts together, must be previously detached. The peritoneal coat adheres but feebly, and may be easily removed by tearing it off, but it is better to cut it away as near as possible to the intestine, so that the latter may not be elongated by dragging.

416. To see the general form of the intestinal canal and its valves it must be distended with air, and allowing it to dry in that state, its membrane, however large an animal it belongs to, will be stiff enough to maintain its form, and may be opened to study its interior, especially its pyloric and cœcal valves, the *valvulæ conniventes*, &c. By soaking fragments of this in clean water they become soft, and are restored to their original condition.

To see a small portion in a fresh state, without the whole of the coat collapsing, as for example, a *valvula connivens*, a little piece of cotton which has been made to imbibe a considerable quantity of water, must be placed on the part; the liquid softens this place, and the surrounding parts remaining dry and stiff, preserve the cylindrical form of the intestine, and serve as a sort of *frame* to the softened portion.

The preparation of *compound stomachs* is exactly like that of *simple* ones.

417. The *villos coat* of the intestines should be examined in subjects carefully injected, in order to see the distribution of the vessels under the microscope, where it forms a very interesting object. It is to be observed with a magnifying power of fifty diameters, which is rather more than is absolutely necessary, but the focal distance is still sufficient to allow the villosity to be examined under a film of water.

418. To study the different coats of which the alimentary canal is composed, it must be macerated in tepid water, which must be changed daily. To render the fibres of the muscular coat more apparent, a distinct reddish tint may be given to them, by boiling in an aqueous solution of nitrate of potass.

419. The *lacteals* should be injected as indicated in the chapter on the circulation.

As to the *glands* belonging to the digestive apparatus, they are prepared like those which secrete the excrementitious matters.

420. PRESERVATION.—The organs of the mouth, forming part both of the skeleton and of the system of

voluntary muscles, must be preserved in the same manner as they are ; the glands always in fluid.

As to the digestive tube (including the œsophagus), it may be either preserved in fluid, or distended with air and dried.

421. Preparations in fluid should be attached to slips of white wood (§ 137), on which they should be fixed as much as possible by their own ligaments, by means of pins, and in a natural position. If the object is injected care must be taken not to employ any preservative solution, which will affect either the material of the injection, or its colouring matter. These effects are spoken of elsewhere, in the chapter on the composition of injections, &c., to which the reader is referred (Chap. 3, Sect. 1). The composition of the fluid, that is, its degree of concentration, should be proportioned to the size of the organs placed in it, so that this fluid may not be too much diluted, and allow the decomposition of the preparation contained in it. However, as all the coats of the intestines are very thin, if they are put at once into too astringent a liquid, the preparation contracts, so as to lose its natural form ; it is better therefore to use the fluid in its ordinary weak state, and to renew it in a fortnight, or a month.

422. Dried preparations being subject to the attacks of destructive insects, care must be taken to wash over the interior with an aqueous solution of corrosive sublimate (§ 121), or what is equally good, to moisten only the outside by means of a brush with the alcoholic solution of the same salt of mercury (§ 122).

## AVES.

423. DISSECTION.—The anatomical processes to be employed in preparing the alimentary canal of birds are exactly the same as those indicated for the Mammalia. It need only be remarked, that the sternal bone being very large, and forming one of the walls of the cavity containing the intestines, in order to expose the latter, this bone must be removed, by separating the sternal from the vertebral portions of the ribs. By this means the abdomen is widely opened, and the whole mass of the viscera found situated in a basin formed by the ribs and the pelvic bones. Then, by placing the trunk on its dorsal aspect, all the organs may be seen with the greatest facility in their natural position.

424. PRESERVATION.—The digestive apparatus is preserved just in the same manner as directed for the Mammalia.

## REPTILIA.

425. DISSECTION AND PRESERVATION.—The organs of digestion in the Reptilia, especially those of the Saurians, are treated much in the same way as those of Mammalia and Birds.

426. To prepare the *poison apparatus* of Serpents, the lateral integuments of the head must be carefully removed in front of the eye. This exposes the temporal and masseter muscles, containing in their interior the poison vesicle; then, by removing the superficial layer of muscular fibres, the vesicle is easily found. The arrangement of the various heads of these muscles must be examined, to try to see how some of them are in-

served into the poison bag itself; these anterior muscles are then to be removed, to allow the vesicle to be entirely detached, especially its neck, which curves on itself downwards, in order to penetrate the superior maxillary bone. The venomous fangs are found in a large projection which the gum forms on each side, a projection which is only a fold of the gum covering the fangs and open behind, to give them free passage.

In turning back the anterior layer of the temporal muscle, which has been completely divided, this muscle is seen to form a sheath to the vesicle, and to adhere to it.

When the sac is opened, it is easy to inject its duct, the cavity of the jaw-bone, and even the fangs; but this must be done with great precaution, so as not to be wounded by the fangs, the poison retaining its deadly properties, even in cases where the animal has been kept a long time in spirit.

The prick becomes especially dangerous when the subject belongs to one of the large species, known by the name of *Crotalus* (rattle-snake), or *Trigonocephalus*.

427. To see the alimentary canal of the Ophidians, the body is merely to be opened along the ventral line, where the absence of a sternum and sternal ribs leaves a long membranous space which opposes no obstacle.

The ribs of the Batrachians are either very short or wanting altogether, so that the abdomen may be opened to see the intestinal canal, without disarranging anything except the skin and abdominal muscles.

Preparations of the digestive tube of reptiles are preserved like those of the higher Vertebrata.

## CHELONIA.

428. DISSECTION AND PRESERVATION.—Preparations of the alimentary canal of the Chelonia are made much in the same manner as those of Mammalia and Birds. It is only necessary to observe, that as all the viscera are closely shut up in a carapax, this cavity must be opened with precaution, in the manner indicated in treating upon the preparation of muscles; that is, from the side, or from below by removing the plastron, which will be easily done in the *Terrapena* where the sternum is moveable, or even in *Trionix* where the entire piece is suspended almost freely in the soft parts; but the coracoid bones will then also have to be removed, with the muscles which belong to them, these bones extending a considerable distance along the anterior portion of the plastron. If, however, their preservation is of no consequence, it is easier and more convenient to open the body from below, by detaching the whole of the plastron. The body being open, the oviducts must not be confounded with the intestines, which they resemble in form and size, simulating their large convolutions which terminate in the cloaca.

## PISCES.

429. DISSECTION AND PRESERVATION.—Preparations of the digestive organs of Fishes are made like those of the higher classes; but the better to see the viscera *in situ* in those species which have the body compressed, (and these form the majority), the abdomen must be opened from the side, by removing all the ribs. By



this means they are not only better seen in their natural situation, but may also be studied in detail without taking them away altogether.



SECT. II.—*ARTICULATA*.—*ANNELIDA*.

430. To prepare the digestive apparatus of Annelidans, the body must be opened in its whole length, either by the back or the belly, according to the aspect which it is wished to expose. For this purpose the animal must be first fixed at its two extremities to a plate of cork by means of pins, then making a small incision to pierce the integuments, as well as the subjacent muscles, the point of a pair of scissars is to be introduced into the visceral cavity, in order to cut open the whole length of the body; but it must be cut in short lengths, and care taken at each cut, to see that no part is implicated which it is desirable to preserve. The animals being soft, the integument may be drawn a little aside with fine forceps, so as to disengage the intestinal tube. The body being completely opened, the two edges of the incision are to be separated by turning back the integument, which must be fixed to the cork with pins. All this ought to be done under water. By agitating the parts gently, they will be seen to detach themselves from each other, so that they may be perfectly distinguished.

431. If the body of the animal is white, a black plate of cork (§ 50) must be used, which allows the parts to be more easily distinguished; if, on the other

hand, it is of a dark colour, for the same reason, a white plate, or the uncovered cork is better.

Preparations of the digestive canal of the Annelida must be preserved in spirit, as, in general, ought all the soft parts of small animals.

### MYRIAPODA.

432. DISSECTION.—To disarticulate the organs of the mouth in the Myriapods, the body must be fixed, with the belly downwards, on a plate of cork, leaving the head free. In this position, if it is a Chilopod, the anterior part of the head, formed by the epicranium, and bearing below the labrum and mandibles, must be removed in a single piece. For this purpose, it is sufficient to make a circular incision through the soft integument which unites this part to the rest of the head, with a fine scalpel, and then to tear it off, destroying the soft parts, whose preservation is not an object; or they may be cut with the scalpel or the microtome (§ 72).

The posterior portion of the cranium must then be disarticulated; this is formed of a segment, encircling the head, and bearing on its under side the fangs used in seizing the prey, which have been wrongly regarded as representing the labium of the Insecta, whilst they are the analogues of their maxillæ. This second segment detached, the soft parts must be removed by means of a scalpel, curved needles, and forceps. Returning then to the anterior portion of the head: it must be fixed (the epicranium downwards), and the labrum removed by

disarticulation, which is easy enough, it being only fixed by the tegumentary ligaments, which are cut along the upper covering of the head. As to the mandibles, placed more deeply, there is a little more difficulty, these organs being attached to the epicranium by moveable articulation or condyle. This joint is easily found by moving the mandible about; and having once remarked where it is, the ligaments which retain it in its place must be cut away all round, without opening with the scalpel the place where the articulation is situated; the mandible only holding by the latter may be torn away by means of a needle bent into a hook.

The different pieces which constitute the maxillæ and the labium, being only united by linear ligamentous articulations, are easily separated, by cutting all round these ligaments with the point of a scalpel.

433. Easy as these preparations are to make, Straus-Durckheim advises macerating the head some time in water till the flesh is decomposed, but not the ligaments.

434. If it is desired to prepare the muscles of the masticatory organs and pharynx, the head must be opened above; for this, the body must be fixed with the belly downwards, placing a short pin in the most anterior part of the head, a good deal inclined, so that it may not be in the way during the dissection.

The head being well fixed, a thin layer must be taken off the epicranium very obliquely with the slice, cutting straight forwards, and *sawing* as little as possible. The cut must be made very obliquely, so as not to injure the organs situated under the integument, or cut into them. When the head is once opened, the aperture may be

enlarged by cutting some strips by degrees from its edges, until the whole of the upper side of the head is laid bare. The object being then placed under water all the *débris* of the organs that have been cut away must be removed in small pieces, taking care not to disarrange any of the parts which are *in situ* until they have been studied.

435. To remove a muscle, or any organ, it should first be completely isolated, by separating it with a curved needle from those surrounding it, so that in taking it away, none of these may be torn off with it; then the muscle should be cut from its two attachments, the tendon with the microtome, and the fibres of the other attachment with a scalpel, a curved needle, or also with the microtome; it may even be as well to tear away the muscle when its tendon has been cut through; proceeding thus by layers, care must be taken to remove all fragments of organs just detached, before beginning the dissection of a fresh one, as these remains generally so confuse a preparation, that the dissection is put a stop to by the impossibility of distinguishing the parts. In these dissections also, much movement of the mandibles, the maxillæ, and lips, must be carefully avoided, as it stretches the muscles attached to them, and may tear them.

436. The alimentary canal may be gently blown up by the anus, so as to fill it out without dilating it too much, in order to see the form it takes; this may be done without displacing the subject. As to the venous glands they are easily discovered in the lateral part of the anterior segments, and with a little care their excretory ducts may be found, and may be disen-

gaged as far as their terminations without much trouble. It is sometimes difficult to follow the biliary and urinary vessels, since they adhere more or less to the intestinal canal, and are easily broken. To isolate them, some point in their course must be taken where they are a little detached; they are to be separated by drawing them out with a needle bent into a hook, and cutting the tracheæ and other filaments which retain them with the microtome. After one portion has been disengaged it must be held out by a pin fixed into the cork. The different parts are separated in the same way, so that ultimately the vessels are detached in their whole length. This is a work that requires much patience and great steadiness of hand, especially when the vessels are very long, very adherent and contorted, as is the case in many Insects.

437. PRESERVATION.—The organs of the mouth are preserved in the same manner as the other solid pieces, but as these parts, as also the antennæ, constitute the principal characters by which the genera are distinguished, it is well to keep them separately and conveniently arranged for observation, as they are in continual requisition. For this purpose M. Straus-Durckheim keeps these organs (and in general all the small parts used in the classification of genera and families) in small pasteboard boxes, shutting air tight. These parts, dried and separated, should be dipped in a solution of corrosive sublimate, and fixed, if very small, upon discs of stout paper with gum. The larger parts may be put loose in the boxes.

The intestinal tube is to be preserved in fluid, like

all soft parts, but exposed as little as possible to the action of light, which blackens these preparations.

#### INSECTA.

438. DISSECTION.—The organs of the mouth, as well as the muscles of the pharynx, are prepared like those of the Myriapoda, by opening the head from above. The alimentary canal, which usually makes various circumvolutions within the abdomen, requires to be displayed; for this purpose the animal is fixed on its belly, and the cavity opened on the upper side. The intestines adhering only to the dorsal surface by the tracheal filaments, it suffices to make a small opening towards the extremity of this part of the body, so as to introduce the point of the microtome, and gently raising the superior arcs to detach the intestines, cutting through the segments one after another as far as the most anterior. The last two rings, ordinarily more solid than the others, should, however, not be opened until the others have been removed, as they give attachment to several muscles, which are inserted also upon the rectum. The longitudinal incision being made, the halves of the superior arcs are to be turned down over the side, cutting as far as possible the tracheæ which retain them, and thus the abdomen is opened in its whole extent. The upper part of the thorax and corselet must be cut horizontally with the slice, so as to remove in one piece a quarter of their height; the alimentary canal being placed lower down, there is no danger of interfering with it. This cut may be made with greater facility before the insect is fixed, by holding it in the fingers.

The body being open in its whole length, with the exception of the two last abdominal segments, these also are to be opened, taking off only the shell of the superior arcs, and that in small pieces, so as not to injure the muscles placed beneath it. The subject must then be fixed upon a cork plate under water, in order to proceed to the dissection of the alimentary canal itself. The different parts of this latter being well detached by floating out, the tracheæ which bind them together must be divided, and this method of disengagement continued until they can be completely separated.

439. To prepare from above the organs of the mouth in Mandibulate Insects, so as to see the pharynx at the same time, the cranium must be opened in the same manner as in the Myriapoda. When the first layers of muscles have been removed, and the mandibles are arrived at, it should be remembered that these organs are only articulated closely with the head, by their superior condyle, where they are fixed by ligaments, consequently that part of the cranium which is next above them must be removed first, especially its external portion where the condyles are situated; the only other attachment of the mandibles being a loose ligament, they are easily detached.

The superior condyle having been disengaged, the scalpel must be passed between the mandible and the cranial-piece outside, in order to divide the dermal layer which unites these two parts; the inferior portion still remains where the articulation is equally loose, and although there is also a condyle in its external part, the latter is never accompanied by any special ligament, so

that when the membranous band that unites the parts has been cut through, the mandible is easily removed; however, before disturbing that organ, the two tendons of the adductor and abductor muscles must be divided near to their insertion, as, if they are drawn out, they will destroy other parts which should be preserved.

440. The two mandibles being removed, beneath them are found the maxillæ, the tongue, and the labium, with their muscles, which may often be prepared together, being situated side by side, except the tongue which overlaps part of the labium. After the tongue has been removed, and the organs proceeding to the maxillæ and labium studied, these pieces may be detached, in order to dissect them separately, by opening their different parts, especially the palpi, with the slice; a difficult operation, on account of the minuteness of the objects. For this purpose, each articulation of the palpus must be held by means of the forceps, on the opposite side from that intended to be opened, and a longitudinal section made with the slice, proceeding from the extremity towards the base. But it is better to employ the method indicated in speaking of the preparation of the muscles of the feet of insects, that is, to fix the palpus in wax.

441. The apparatus for trituration may be prepared in three ways: the first consists of making a longitudinal incision in the gizzard, spreading it out and fixing it on a small piece of cork, on which it is kept stretched until dry; the second plan is first to remove all its contents, by directing a jet of water into it from a small syringe, to blow it up and dry it in a state of inflation, so as to



cut it then into two pieces, which show the parts *in situ*; the third method is to macerate the gizzard until the epithelium, with the solid parts which belong to it, become detached from the tunica propria. This is then easily removed in layers, and the triturating apparatus obtained completely isolated, the parts holding together and often forming a little lantern of very beautiful construction.

442. These preparations are preserved like those of the Myriapoda.

#### CRUSTACEA.

443. DISSECTION.—The organs of the mouth are prepared exactly in the same way as those of the Myriapoda and Insecta. As to the intestinal canal, which is also exposed as directed for the latter animals, it must be inflated by the anus to see its form, then taken in one piece from the containing cavity, and water poured through it until it flows out clean at the opposite end. After having well washed the interior, and emptied all the water out, a ligature is to be placed at one end, and it must be filled with air from the other, which is then to be tied, and the whole allowed to dry.

444. If by any accident there should be a small hole in these viscera, they may be distended with grains of millet or any other fine and smooth seeds, such as trefoil, linseed, or rape seed. The small size of these seeds allows them to lodge in the smallest folds and crevices, and the smoothness of their surfaces prevents their sticking. Thus distended, the object may be dried, and the grain then shaken out by the same orifice.

445. To restore, if wished, the natural form to the part where the ligature has been placed, it is merely necessary to soak it in tepid water, so as to soften it; it may then be distended anew, by filling it with any fibrous substance, which should be previously well greased, to prevent its sticking.

446. To see the liver, the body must be opened by the back, as for the intestinal canal, always taking care not to penetrate too deeply into the cavity, for fear of injuring the viscera, which are often placed (especially in the genus *Astacus*) in the dorsal region. After having exposed it, the subject should be placed in water, which must be agitated for some time to detach from one another the lobes and vessels of this organ; and having well examined it *in situ*, so as to be certain of its relations, it may be extracted with the alimentary canal, and its details seen. The biliary ducts may be distended from their orifices in the gizzard, or even injected, if large enough.

447. To prepare the alimentary canal of the *Limulus* in its whole length, the body must be opened by the interior profile, and by the back, to see the biliary vessels.

448. All these preparations are preserved like those of Insects and Myriapoda.

#### ARACHNIDA.

449. DISSECTION.—When the pharynx of the Pulmonary Arachnidans is to be prepared, the trunk should be opened at the side, cutting it vertically at a little dis-

tance from the median line of the body, so as to see the side view, as also the dilator muscle. In front of the inner cartilaginous sternum will be seen the œsophagus, forming a very narrow canal, and across its neck a ring, formed by two nervous cords going from the brain to the inferior ganglion; but these two cords are so short, that the two nervous expansions appear as if merged into one, through which the œsophagus passes. The gizzard is also then well seen; but it may be quite as easily found by opening the animal from the back; and as it is entirely enveloped in muscles, it requires care to disengage it.

The part of the intestinal tube which is situated in the abdomen may be best seen by opening that part of the body from above.

450. The digestive apparatus of all the Arachnidans is preserved like that of the other classes of articulated animals.

---

### SECT. III.—MOLLUSCA.—CEPHALOPODA.

451. DISSECTION.—To see the digestive organs of the genus *Octopus*, the body should be opened along the dorsal line, and the different peritoneal pouches which enclose the alimentary canal successively cut into. If opened in front all the organs situated in the sac will be in the way; and even after they are detached, the liver, situated in front of the digestive tube, still remains to be removed. In *Sepia* and *Loligo*, on the contrary, it is better to open the body from the under surface, on

account of the obstacle presented by the shell which is placed in the dorsal region. The mandibles may be preserved dry, but the other parts must be put into fluid.

#### GASTEROPODA.

452. DISSECTION.—In order to prepare the digestive apparatus of the Gasteropods in general, the body must, as usual, be opened above along the median line, but with some variations, according as there is an external shell or not. Among the species which possess an internal shell, those individuals may be very advantageously employed for this purpose, in which the capsule of the shell, the pulmonary cavity, the heart, and the gland of the viscosity have been examined. After all these parts have been seen, in the *Limax* for instance, an incision must be made along the back, from the posterior border of the mantle to the extremity of the body, a little to the left side, so as not to injure the retractor muscles of the head and the tentacula. A second cut should then be made transversely behind the mantle, in order to have a wide opening into the visceral cavity. By this are exposed, on the right the stomach, on the left the liver, situated at its posterior extremity; more anteriorly, the ovarium; and still more so, the terminal convolutions of the intestinal canal: continuing the incision along the anterior part of the body, that is, along the floor of the pulmonary cavity, and the neck, as far as the head, the anterior convolutions of the intestinal canal are also exposed, placed altogether on the right side; also the salivary glands, which must not be con-

founded with the oviduct, or the folds of the penis, which are of the same white colour. The penis is in the middle, beneath the anterior part of the mantle, and the salivary glands on each side of that organ.

453. The body being thus opened in its whole length, the filamentous tissue should be examined, which is reflected from the walls of the visceral cavity over all the organs contained within it, where it forms between some of them a condensed layer, which envelopes them like an excessively fine sheath not adhering to them. This sheath must be cut in all places where the organs are in contact, so as the more easily to separate them.

454. The retractor muscles of the head remaining attached to the integuments on the right side, the manner in which the extremity of the intestine is reflected over them at their origin will be seen; a small portion of the integument, to which they are attached, should then be cut, so that they may be turned back, to allow an opportunity of seeing how the most anterior curve of the intestinal canal (situated at the left side) is reflected round the aorta at its exit from the heart.

In separating the lobes of the liver, those of the ovarium, and the convolutions of the intestines with the large arterial trunks going to these parts, will be seen passing freely between them.

455. Those species with an external shell are to be opened, as indicated in Chap. V. To render the intestinal canal more distinct it may be injected by the mouth, or still better, by the anus, taking care in *Helix*, to direct the pipe along the commissure of the two last

turns of the spire. The anus may be found by inflating it from above with a blow-pipe.

456. PRESERVATION.—To preserve preparations of the viscera, it is a good plan to keep them several days in weak spirit, after having opened the body and separated the various organs from each other, in order to give them a little consistence; without this there is a danger of tearing them.

#### ACEPHALA.

457. DISSECTION.—The digestive apparatus of the Acephala Ostracodermata is difficult to prepare, on account of its close adhesion to the liver and ovarium, in the substance of which it is excavated, as if they were its own peculiar cavity. However, with a little care, and above all with patience, it is possible to dissect it out.

458. In the first place one of the valves must be raised by the means indicated in the chapter on the muscular system.

The valve having been removed, and the other containing the animal fixed upon a piece of cork, the mantle and branchiæ on the exposed side are to be cut through, and the body opened in its whole surface between the foot and the back, by lifting up the muscular tunic, which forms its parietes; this should be done without penetrating deeply into the mass of the liver and ovarium placed beneath, for fear of injuring any part of the intestinal canal. The removal, at once, of all the muscular layer forming the visceral sac, is advisable, as

afterwards, when the demonstration of the parts of the digestive apparatus is commenced, they are easily destroyed in the endeavour to dissect off the remainder of this coat, which is very coriaceous. The visceral sac being thus open, the liver which adheres to it is necessarily opened in its whole surface, and not only the bile, but even the numerous particles of the parenchyma of this organ are set free, and so discolour the water, that everything is soon rendered invisible. Without changing this, since it would be clouded again directly, the liver should be washed by rubbing it gently with a soft hair-pencil; in this manner the bile is extracted, and at the same time a good deal of the parenchyma removed, so that at last nothing remains but its spongy portion. The water may then be changed so as to see what has been done. The lobes of the liver are to be cut into with the microtome, without going too deeply, and the deeper parts washed with the brush, as they are exposed, in order to reduce the mass of this organ still more. When some portions of the intestinal canal begin to appear, their course must be followed by wholly exposing them, and by continuing this method the entire apparatus will ultimately be seen, though rarely all at once, for it is very often necessary to take away the superficial parts in order to reach the deeper ones. Before cutting them away they should be opened longitudinally, to see their interior.

459. The mouth is often rather difficult to find, as in many species it is deeply seated among the anterior muscles of the body, which are generally torn in taking off the valve; but it may be discovered by tracing the

labial appendages to their insertions, between which the mouth is ordinarily situated. As to the anus, it is easily perceived in the middle of the posterior surface of the posterior adductor muscle, where it often projects.

460. As the chyme and the excrements which filled the intestinal canal offer much assistance by their varied colour (frequently whitish), in finding and following out the different convolutions of the intestines, M. Straus-Durckheim advises, as far as possible, that those individuals only should be dissected for this purpose which have not been long without food, and which are, consequently, not free from excrement.

461. The alimentary canal is preserved like other soft organs.

---

#### SECT. IV.—*RADIATA*.—*ENTOZOA*.

462. *DISSECTION*.—The Entozoa are generally opened from the back to expose their viscera, especially the Cavity Entozoa (*Cœlelmintha*), whose internal organs are free in the abdominal cavity; but in the *Parenchymata* the dissection is more difficult, and it is well to inject them by one of the extremities, the better to see their disposition; besides, the matter introduced by its solidity serves as a guide in tracing them through the mass of the body.

463. The preparations are preserved like those of the *Annelida*.

#### *ECHINODERMATA*.

464. *DISSECTION*.—The best view of the intestinal



canal of *Holothuria* is obtained by opening the body in its whole length from the ventral surface.

The *Echinus* ought, on the contrary, to be sawn in two at an equal distance from the poles, being careful not to cut too deeply for fear of injuring the intestine. By always placing the saw above, the weight of the digestive canal will in some degree separate the viscera from the arch of the shell on which the saw is acting.

465. As to *Asterias*, it must be opened above to see the digestive apparatus most advantageously, as also the ligaments and the meso-cœca. For this purpose the first operation is to make, through the integument at the extreme border of each ray, two longitudinal incisions, which are to be prolonged as far as the bases of the rays; then raising the borders of these slits, the meso-cœca are perceived towards the middle line, descending from their arch. If necessary, these openings may be then enlarged in the direction of these suspensory ligaments, removing small portions at a time, until only just the width of the band of integument which sustains them is left. Having noticed their disposition, a small opening should be made in the centre of the superior surface of the integument, which must be enlarged evenly by small degrees, in order to see within the suspensory ligament of the stomach; this is then to be cut close to the integument, and the end of each slit in the rays prolonged into the central one.

The stomach being wholly displayed by this process, its continuity with its cœca is seen, and around, the falciform ligaments which curve over its sides to terminate in a point near the border of the mouth, and are si-

tuated in the re-entering angles of the rays, which they prolong as far as the stomach.

466. None of these incisions should be made in the rays placed next the falciform ligament containing the heart and the sand canal, whose situation is indicated exteriorly by a plate of peculiar form placed at the junction of two rays. On this side the incisions in the rays should be made and enlarged last of all, when the disposition of the cœca and ligaments have been well studied in the other rays, so that the falciform ligament containing the heart and sand canal may not be injured. These parts must be approached with caution.

467. After having examined the digestive apparatus in its general arrangement, the cœca should be cut at their origin, and removed with the tegumentary band to which they are suspended. It is as well to leave this band in all its original width in one or more rays, to serve as a support to those cœca which are to be preserved, as they are more conveniently suspended upon slips of wood, than by means of pins.

468. The cœca being removed, the radiating ligaments of the stomach are found beneath, arising in pairs from the latter to be inserted on each side of the vertebræ, in about the first fourth of each ray.

By blowing into the cœcum all its little branches are easily filled with air, having then the form of small subdivided vesicles.

469. Preparations of all these animals are to be kept in fluid, which must not be acid, as their shell contains much calcareous matter.

## ACALEPHÆ.

470. The ramified intestinal canal may be injected by the mouth and the suckers, which renders it more distinct, especially if the parts are to be dissected. This dissection will be found very difficult in fresh subjects, the body being extremely soft, and sinking down completely when out of the water; but the almost perfect transparency of the body of several of these animals, allows the disposition of the organs to be seen without dissection.

The bodies of these animals are difficult to preserve on account of their want of consistence, more especially in spirit, which makes them contract strongly.

## POLYPI.

471. Scarcely any other preparation can be made of the digestive organs of Polypes, than cutting their body in half longitudinally to see the interior. The *Actiniæ* alone which are sometimes very large, might be really dissected with care; and it is much to be desired that some one would make out the complete anatomy of them, to serve as a basis to the comparative anatomy of this class of animals.

To prove that the digestive cavities of all the Polypes on one base communicate with each other, and that the nutritive particles which each absorbs are common to all, Milne Edwards has injected a single head in certain compound Polypes, and the mass passed into all the other animals seated on the same Polypidom.

## INFUSORIA.

472. Although these animals cannot really be dissected by means of the scalpel, some parts of their intestines may be seen, on account of the transparency of their bodies; and by long observation, the form and disposition of certain of these organs may be sometimes understood, especially in the large species, such as *Brachionus*. But, according to the ingenious observations of M. Ehrenberg, these little animals may be prepared so as to render the alimentary canal more apparent (§ 205). The animals swallow the colouring matter, and then, by placing them at once in cold water, the coloured intestine is seen, the rest of the body remaining white.

---

  
CHAPTER VIII.~~~~~  
SEROUS SYSTEM.  
~~~~~

MAMMALIA.

473. THE serous membranes, such as the arachnoid, the pleura, the peritoneum, &c., can hardly be prepared separately from the organs they envelop. To study them upon each, they are raised and detached mechani-

cally with the handle of a scalpel, or simply with the finger. These fragments are examined under the microscope, and in water, to see their cellulo-fibrous structure. As to the expansions they form, they are studied upon the organs to which they serve as bands. The *epiploons*, forming vast free membranes, may be easily removed and preserved, either in the dry or wet form.

480. AVES, REPTILIA, CHELONIA, exactly the same as in the preceding class.

PISCES.

481. The *peritoneum* is very easily removed in those Fishes where it is coloured, from its being thus better distinguished and being generally slightly adherent, and is preserved like that of other Vertebrata.

482. The dissection and preservation of the serous membranes, where they exist in the last three divisions of the Animal kingdom, is conducted together with the organs, especially the digestive, of which they form a part.

CHAPTER IX.

GLANDULAR SYSTEM.

SECT. I.—*VERTEBRATA*.—MAMMALIA.

483. DISSECTION.—The kidneys and supra-renal capsules, and even the bladder, may be very well prepared separately; but the urethra, which opens externally with the genital organs, must be prepared at the same time as the latter.

After the relations of the *kidneys* with the surrounding organs have been examined, they may be removed, which is easily done, as they are only fixed by the vessels and nerves belonging to them, and a mass of fatty cellular tissue which surrounds them. When they have been divested of this fat, and their proper fibrous capsule has been examined, the kidney should be divided through its longest diameter into two equal parts, the cut being made so as to pass out by the middle of the hilus. In this way a section is made, which divides at once the cortical and tubular portions, the papillæ, the calices, and the pelvis.

484. If it is intended to study the urinary canals in detail, the kidney must be previously injected, and it is better then not to make the incision exactly through the mid-

dle, but rather to one side, so as not to injure the ureter. Injections of the renal arteries often pass, when carefully made, into the excretory ducts. This circumstance has led to the erroneous opinion, that an open communication existed between the ducts or acini and the capillary blood vessels, which ramify upon them. The true explanation, however, appears to be, that it has been caused by rupture and extravasation of the injection from one set of vessels into the other.

485. The *bladder* is prepared by blowing into it moderately, to give it the volume which it usually has when full. Thus distended, the position of the ureters may be examined. A sound is to be introduced to see the oblique direction of these canals between the coats of the bladder, which may easily be inflated through them. The coats of the bladder are then to be dissected, to see the disposition of the muscular bands which form with each other a kind of sphincter.

486. The kidneys should be injected, and then corroded or macerated, in order to obtain a cast of the interior of the excretory canals. This injection should be made by the orifices of the tubuli uriniferi, upon the papillæ which project into the calices, because it is difficult to make it penetrate from the ureters. The blood vessels may be injected at the same time, so as to obtain in one preparation, the three principal kinds of vessels, which enter into the composition of these organs.

As the kidneys can be easily removed from the body with the common trunks of their vessels, and excretory canals, the blood and air may be extracted by means of the pneumatic bell (§ 40), before injecting them.

487. The other special glands are to be prepared at the same time that the surrounding parts are dissected.

As soon as they are laid bare (even a portion will be sufficient when investigating them in an animal, whose organization is not very well understood) their excretory ducts must be sought for, and the position of their orifices will be quite enough to indicate the function of the organ. These canals may be found, by following either through the parenchyma of the gland the first branch that is met with, or equally well, by disengaging the gland from all the neighbouring organs, when the common trunk of the excretory canals will necessarily be seen, and must not be confounded with the vein or artery. There is another plan (and it is the best when applicable), which is, to inject merely some water into the first branch of the excretory canal that is found; the water, by flowing out at the common orifice, will indicate its position.

488. If the orifice of the excretory duct is already known, it should be injected with some substance which will harden, so that, in dissecting the gland, the mode of subdivision of the canals may be traced. Lastly, the lobes of the gland should be at once dissected with a lens under water, to endeavour to see the origin of the canals, as well as the form, arrangement, and structure of the little simple glands from whence they arise. The injections are best made with the large or small injectory (¶ 33), as the force may be measured, and the jet of fluid let on or stopped at pleasure. For the injection of very small glands, it is better to use the

caoutchouc bottle (¶ 29), the clysette (¶ 31), or the pipette (¶ 32).

In his first attempts, the operator should be content with injecting very small glands with coloured alcohol or water; in many cases injection may be dispensed with altogether, if the organ is turgid with its own peculiar secretion. By gently compressing it under water, this liquid is made to flow from the orifice of the excretory canal, the position of which is thereby indicated.

489. If the gland is very large, as the liver or pancreas, not only the excretory ducts, but the veins and arteries also should be injected, in order to see the relations and arrangement of the three kinds of vessels; perhaps it may be possible even to inject the lymphatics.

In this quadruple injection different coloured substances must be employed—for the arteries, vermilion; the veins, dark blue or black; the excretory vessels, green; and for the lymphatics, white or yellow.

490. It is said that good preparations of the vessels of glands may be made by destroying, by maceration in water, the parenchyma which unites them; this parenchyma (generally of a looser texture) decomposing sooner than the membranes, which form the vessels and excretory canals, so that the latter remain after the former has been quite removed. The process is as follows:—the entire organ must be macerated for several days in tepid water, until the membrane forming the general envelope can be easily detached; it is then to be wholly removed. The maceration is still to be

continued, taking care to wash the preparation daily with a syringe (which must be used gently, so that only the decomposed portions are removed) until nothing but the vessels and their numerous ramuscles remain. The maceration must then be stopped at once, for fear the vessels themselves should be decomposed. The specimen is to be well washed, and allowed to soak some hours in clean water, which must be changed two or three times. Lastly, the preparation should be placed in some preservative fluid.

491. The preparation of the *thymus* and *thyroid glands*, consists in injecting them, after which they may be dissected at once. M. Straus-Durckheim recommends this being done under water, which not only carries away the extravasated fluids, but also allows the lobes and lobules which are separated to be more easily discerned, whilst in dissecting in air the parts all adhere together, and it is scarcely possible to distinguish anything.

492. PRESERVATION.—The kidneys and all other special glands must, of course, be preserved in fluid, but the bladder may be dried. For this purpose it must be blown into moderately, so as not to distend it too much, then dried in a current of air and washed over with a solution of corrosive sublimate.

Those special glands which have a cavity may be injected with some coarse material, in order to obtain an internal cast, to see the form of the cavity. This may be done with wax, fusible metal, or simply with plaster, (¶ 38, 101, 106).

AVES.

493. The kidneys of birds being deeply seated in the anfractuositities of the pelvis, are very difficult to remove, and are best prepared *in situ*. These preparations are limited to injections of the excretory canals, made either by the orifices of the ureters in the cloaca, or by cutting into those ducts in any part of their course.

If corroded preparations are to be made, the kidneys should also be left in their places in the pelvis.

REPTILIA AND CHELONIA.

494. The *kidneys* and *urinary bladder* of Reptiles and Chelonians, are prepared exactly in the same manner as those of Mammalia and Birds. They may be extracted to inject their excretory vessels separately, and are also to be preserved in fluid.

Their other special glands, which are not very large, may be preserved with their neighbouring parts, and the very small ones, placed beneath the skin, examined when studying that part.

PISCES.

495. The *kidneys* of Fishes being placed in the abdomen, along the vertebral column, in order to expose them, this cavity must be opened from the belly, half the length of the ribs cut away, the subject placed on its back, and all the other viscera which conceal them removed. The ureters should be injected to see their distribution in the kidneys.

The *mucous canals*, which open upon the lateral line of the body, are to be injected by their anterior extremities, which proceed from two glands, placed above the eyes, which furnish the peculiar viscous secretion adhering to the body of Fish.

496. To prepare the *electrical organs* of the *Torpedo*, the body should be opened above, the skin being first carefully removed, and then the parts covering these organs, by small portions at a time, which will allow the branches of both the maxillary and pneumogastric nerves, which (according to Cuvier) are distributed to them, to be followed out.

The electric organ of the *Gymnotus*, placed beneath the tail, should be dissected from the side, the better to see the edges of the small lamellæ of which it is composed.

497. The best view of the *swimming bladder* (especially in those Fishes which have the body much compressed) is obtained by removing, on one side, the ribs with the muscles attached to them; a side view of the visceral cavity is thus obtained, which allows also the respective relations of all the other organs to be carefully studied.



SECT. II.—ARTICULATA.—MYRIAPODA.

498. THE urinary organs of the Chilopoda are best seen by opening the posterior part of the body from above. They are situated on each side of the terminal portion of the intestinal canal and the genital organs,

but must be detached with care, cutting one by one the tracheæ which retain them, so as not to break the excretory duct, which is extremely slender.

After having entirely removed the superior arcs of the segments of the animal (which should be previously fixed on a plate of cork), the glands are to be detached in the manner just described; this being done, they should be removed from the cavity of the body, and fixed to the side of the cork, the excretory duct unravelled, and its convolutions followed as far as their termination.

499. These preparations are preserved with the genital organs, to which they are appendages.

INSECTA.

500. The *urinary* organs are prepared with the alimentary canal to which they are appended, exactly in the same manner as the hepatic vessels, which they much resemble.

As to the *stings* and *poison vessels*, they require more care, these structures being very small, and much complicated by the different horny pieces which belong to them, the muscles which move them, and by the secreting portion which produces the poison. In order to prepare them, the abdomen must be first of all opened from above, to get a good view of the disposition and relations of the whole; then the posterior segment may be taken away, with all the poison apparatus, fixed on a small piece of cork, and placed under a lens (magnifying about ten diameters for such an insect as *Vespa-crabro*). The regular dissection of the parts is then to

be proceeded with, taking a direction sideways, from the exterior towards the interior, as far as the median line of the subject where the sting is situated, attached to the excretory duct. Then continuing the dissection from within outwards, in the other half of the segment the real arrangement of the parts may be understood, which could not easily be done before, in going from without inwards.

This apparatus being intimately connected with that of generation, they should be examined together.

501. The best way to fix such small objects on the plate of cork, is to leave one or two of the hinder segments of the abdomen attached to them, through which the pins may be stuck; these of course should be firmly fixed and very short.

502. The other secerning organs, and those supposed to be such, as the appendages certain Insects protrude from their bodies when in danger, are to be prepared with the neighbouring integument, and ought to be examined from the interior of the body, to ascertain their nature and the means by which the insect extrudes or retracts them.

503. For exposing the *serigenous vessels* in the larvæ of certain Insects, as those of the Lepidoptera, the body must be opened along the median line, and the edges of the incision being drawn aside, they are readily disclosed, without much dissection, as two elongated blind sacs, lying upon either side of the alimentary canal, their excretory ducts terminating upon the under surface of the labium. The glandular organs are preserved like the other viscera.

ARACHNIDA.

504. The glandular organs of the Crustaceans and Arachnidans are prepared and preserved as in the other Articulata.



SECT. III.—MOLLUSCA.—CEPHALOPODA.

505. THE *Ink-bag* of *Octopus* is found by slitting the sac and the cavity of the abdomen along the median line anteriorly. When the first of these cavities has been opened, and its margins separated, the second should be opened from top to bottom as far as the anus; then, having noticed the excretory duct, which ends near the latter, a cut should be made at the side of the anus, through the parietes of the abdominal cavity, so as to open it entirely, leaving the anus and the excretory duct on one side; but care must be taken not to open the ink-bag itself, as the ink would so stain the preparation, that it would be of no further use. In specimens preserved in alcohol this matter is thickened, but still soluble in water.

GASTEROPODA.

506. It is difficult to discover the pores from which the viscous secretion covering the body of *Limax* issues, these orifices being situated at the bottom of the folds formed by the integument; but the fluid may be seen to ooze out when the body is scraped with a knife.

The follicles which secrete the material of the shell are found in Gasteropods outside the shell, by opening

the thickened portion forming the border of the mantle, this part being chiefly made up of them.

To see the colouring fluid of *Aplysia*, it is only necessary to squeeze the border of the mantle, and it will then issue from it.

507. The *gland* of the *viscosity* is easily exposed in *Limax* and *Helix*. In the first the cavity containing the shell should be opened by a crucial incision made over the adherent portion of the mantle; then turning back the four slips, the shell may be extracted, beneath which the viscosity gland is situated; it may either be blown out, or its duct injected from its orifice, which is placed more posteriorly than that of the pulmonary sac.

508. In *Helix*, half of the last whorl of the shell must be removed, and the gland will be seen placed in the middle of the posterior surface of the herniary sac, where it is distinguished by its yellow colour. It may be inflated with air, or else injected by its duct, placed beneath the vena cava, in the thickened portion formed by the first turn of the herniary sac in its upper part.

ACEPHALA.

509. To see the organ producing the threads called *bysus* in the *Pinna*, the body must be opened at the side as usual, and it will be found in the interior at the base of the foot, where it is easily recognized.

These organs are preserved like those of the other Mollusca.

510. Too little is known of the glandular organs of the Radiata to merit any notice upon the methods of dissecting and preserving them.

CHAPTER X.

~~~~~  
 GENERATIVE SYSTEM.  
 ~~~~~

SECT. I.—*VERTEBRATA*.—*MAMMALIA*.

511. **DISSECTION.**—The study of the genital organs, male as well as female, should obviously be divided into three separate stages. In the first place, the external and superficial parts are to be examined; next, the internal; and the preparation is completed by the dissection of the external deep seated parts.

512. After having examined the disposition of the scrotum, penis, and their external parts in the *male*, the preparation of the scrotum, and the organs contained in it, should be commenced by following the different coats to their origin, the fibrous tunica vaginalis included. The tunica vaginalis, which forms like all serous membranes a shut sac, is to be inflated so as to recognize its extent. After having removed it, the dissection of the testicle may be continued separately, by cutting through the spermatic cord previous to its entrance into the abdomen, or waiting until the whole apparatus can be detached in a single piece, which comes to much the same in the end. To see better the arrangement of the corpus Highmorianum on the detached testicle, a longitudinal incision is made, passing as near as possible

to the commencement of the epididymis. In tracing the parts afterwards, it will be seen how the corpus Highmorianum is composed of the canals of the rete, and prolongations of the albuginea investing them; and how the first are continuous with the vasta recta, and these with the seminiferous tubes. These last form each a ball which may be unwound, but not without difficulty, on account of their extreme delicacy; an operation which should be therefore done under water. For this purpose it is recommended to macerate the testicle for some time in water containing potash, which causes the tubuli seminiferi to detach more readily from each other, but after having thus macerated it, the testicle must be put back some days in alcohol to harden it.

Having arrived at the spermatic cord, properly so called, formed by the vas deferens, and its accompanying vessels and nerves, the abdomen should be opened, endeavouring in so doing to preserve intact the passage of the inguinal ring, so that it may serve as a guide. The vessels and nerves are to be followed out to the trunks from which they arise, and by tracing the deferential canal, the vesiculæ seminales, if existing, will be recognized.

513. Turning back afterwards the testicles upon the inguinal rings, the muscles of the perineum are dissected from without, care being taken to raise the integument cautiously, so as not to injure the subjacent parts, which are the sphincter ani, the corpus-cavernosum, the bulb of the urethra, the ischio-cavernous, bulbo-cavernous, transverse-cavernous, recto-cavernous muscles, the caudo-rectal, the terminal portion of the pubio-caudal (ele-

vator of the anus), and that of the ilio-caudal muscle (also an elevator of the anus).

514. After having examined these parts *in situ*, without detaching them, the pelvis should be opened by removing one of its lateral halves, which is to be disarticulated at its two symphyses, the ilio-sacral and pubic, after having cut on a level with the bone all the organs which are attached to the piece to be removed. The pelvis being opened, the deferential and ejaculatory ducts are to be traced within its interior, to the entrance of the latter into the urethra. It is then that the terminal portion of the intestinal canal and urinary apparatus can be also easily studied. The muscles of the perineum, on the side where they remain in place, will serve to indicate the arrangement of those which have been detached; and after having removed these last, the prostate with Cowper's glands, may be recognized and dissected, and the arrangement of the urethra and the corpora cavernosa seen. Lastly, having seen these parts *in situ*, the genital apparatus is detached on all sides, so that each of its parts may be examined in detail. For the urethral canal, a sound is introduced by the penis into the bladder, as upon this the canal can be more easily cut into.

515. For preparing the *corpora cavernosa* a small opening is made, before detaching them from the ischia, in one of their roots, to introduce the canula of a syringe, and squirt warm water into them.

By this means these organs swell as in erection, and being afterwards squeezed, the liquid is forced out with some of the blood which was contained in them. This

operation is repeated until the water returns clear; then having as well as possible driven it all out, they are forcibly inflated, a ligature placed on the two roots, and detached. In this state the specimen is dried, and opened afterwards along one of the sides, to see the arrangement of the internal fibrous partitions. The corpus cavernosum can be also injected with mercury, and the latter poured out when the specimen is dry.

516. The study of the *female* genital organs may be conducted in the same manner. After having examined externally the vulva, the nymphæ, clitoris, hymen, and orifices of the urethra and vagina, the abdomen should be opened by raising the abdominal muscles upon a level with the bones of the pelvis, leaving simply *in situ* the part which contains the inguinal rings, through which the round ligaments of the uterus pass out. After having removed the mass of viscera dependent upon the digestive canal, the bladder is disclosed superficially within the true pelvis, behind the pubis; and the uterus contained in its broad expanded ligaments divided into two wings, the posterior of which contain the ovaries, and the anterior the Fallopian tubes.

517. These parts having been recognised in their place, each ovary may be separately excised, its structure studied, its Graafian vesicles observed, and if possible, the ova they contain; the large ligaments being afterwards removed to see the uterus enclosed between them; and lastly, the pelvis opened from one of the sides, as has been mentioned before for the male; but it is better to begin by opening the pelvis, so as to see a profile of all

the organs *in situ*. In this state the relations between the genital and urinary organs can be better recognised, and each part removed afterwards separately, to examine its contexture.

After having seen the large ligaments, the round should be exposed, which extend from the superior angles of the uterus to the inguinal rings, through which they pass out to be lost in the groin.

In the uterus, the direction of its muscular fibres should be endeavoured to be recognised; and in its interior, the form of the cavity and the mucous follicles.

518. PRESERVATION.—The sexual organs, both male and female, should be preserved for the most part, like the viscera generally, in fluid.

Some parts, however, may be preserved in the dry state; for example, the bone of the penis and penis itself, the corpora-cavernosa of which have been filled with air and dried, to see the arrangement of the internal fibres, and some dried preparations of the membrane of the hymen; but all these dried soft parts should be washed over with corrosive sublimate, to preserve them from destructive insects.

AVES.

519. The internal genital organs of the two sexes being placed along the vertebral column within the pelvis, the body of Birds must be opened from the belly to expose them. For this purpose, all the vertebral ribs are cut through their middle transversely, and the integument with the abdominal muscles, along the iliac

and pubic bones to a level with the cloaca, and the upper part of the subject is then placed upon its back to proceed with the dissection in detail, after having previously removed the alimentary canal as far as the rectum, where it is to be cut across.

These preparations are preserved like those of the Mammalia.

REPTILIA.

520. In the class of Reptiles the preparations of the genital organs are made precisely as in Birds, from which they differ but little.

CHELONIA.

521. The preparation of the genital organs of the Chelonians demands especial care, like that of all the soft parts of these singular animals. These organs being placed in the posterior part of the carapax, the scapulæ are no hinderance to their being seen and dissected from below; and in that manner it is convenient also to prepare them. For this purpose the posterior half and even two thirds of the plastron is to be removed, by sawing upon each side the angle formed by it with the carapax, as has been indicated in the chapter upon the muscles. After having exposed the mass of viscera, the intestinal tube is raised to within a small distance from the cloaca, and cut across, and the examination of the exposed genital organs proceeded with in the same manner as for Reptiles and Birds.

PISCES.

522. The genital organs of Fishes should be seen from below, and the animal is therefore opened from the belly. The anatomical specimens are preserved like those of the other Vertebrata.



SECT. II.—ARTICULATA.—ANNELIDA.

523. The body is opened along the back, and the edges of the incision turned down to see the genital organs of the two sexes fixed to the ventral surface, and the preparations are preserved like all other soft parts.

MYRIAPODA.

524. The preparations of the genital organs of Myriapoda are made like those of the other viscera, by opening the body along the back; and as these organs are placed immediately beneath the heart, care must be taken not to thrust in the cutting instruments so as to wound them.

INSECTA.

525. The genital organs of the two sexes being constantly placed in the abdomen, will be prepared by opening this cavity from above. For this purpose, the superior arcs are to be cut through their middle with fine scissars, and the two edges turned back, or, especially in those which have a depressed abdomen, a small piece

may be cut out with the scissars from their lateral margins, so that all the dorsal arcs may be removed in a single piece. But in this last operation there is a risk of damaging the internal parts which it is wished to preserve, and M. Straus-Durckheim prefers, therefore, opening the body from the median line. The intestinal canal is raised, and cut at a small distance from the cloaca, and the genital organs found beneath, filling principally the inferior and lateral part of the abdomen. The preparations may be either preserved in the inferior part of the abdomen, reduced simply to the integument, which forms a dark ground for these organs, which are generally white; or the posterior segments only may be preserved to which the cloaca is attached.

CRUSTACEA.

526. To prepare the genital organs of the Crustacea, the body must most frequently be opened in the ordinary way from the back; but in very small species, the integuments of which are transparent, they may be seen through the body of the animal in an entire state.

The spermatic vessels may be well enough traced in individual *Limuli*, killed at the period of their pairing, when these organs are crammed full of white sperm, which the preserving fluid coagulates; the terminal trunks of these vessels are more than $\frac{2}{5}$ ths of an inch in thickness.

As to *Astacus*, it should be opened with precaution, the testicles, as well as the ovaries, being placed immediately beneath the buckler. The males should be se-

lected in preference during winter, when their seminiferous tubes are largest, and the females in spring, before laying, and small or young specimens which lay for the first time, rather than old, their ovaries being less developed, and containing but a small number of mature ova.

The preparations are preserved in fluid.

ARACHNIDA.

527. In the Araneida, the testicles can seldom be prepared but on fresh subjects, as they are extremely weak, and rupture easily when these animals have remained some time in fluid, at the same time that they are then but very indistinct from the fatty body which envelops them.

528. As to the excitatory organs enclosed in the last joint of the palpi of the male, Treviranus recommends our killing these animals in boiling water, when these parts develop completely by protruding from their case; but they must only be left one or two minutes, so as not to undergo any alteration, and placed afterwards in an alcoholic liquid.

For preparing the genital organs of the two sexes, the body ought to be opened from the back.

SECT. III.—MOLLUSCA.—CEPHALOPODA.

529. For preparing the genital organs of the Cephalopoda, *Octopus* in particular, the body is to be opened

along the belly; that is to say, at first the ventral sac, and then the different cavities inclosing the other viscera; these being removed, the testicles are found placed in the bottom of the sac, against its dorsal parietes, and consequently against the shell in those species which have an internal one, as the *Loligo*. Lastly, the peritoneal sac is cut into, which is placed quite at the bottom, attention being paid, not to open at the same time the membranous capsule which envelops the testicle and ovary.

These organs are preserved like the other soft parts.

GASTEROPODA.

530. The same methods are employed for preparing the genital organs of the Gasteropoda as for their alimentary canal; care only must be taken not to slit the anterior part of the body in the same situation where the orifices of the genital organs are, which should not be opened until after the arrangement of the internal organs has been well understood.

The herniary sac may be left in like manner attached to the columella, which is to be preserved, so that the latter serves as a support to the organs it is wished to keep; or, the herniary sac may be extended, by cutting here and there the ligament which fastens it to the columella.

ACEPHALA.

531. The preparation of the genital organs of the Acephala is commenced as for their other structures, by raising one of the valves, care being taken not to injure

the mantle; and after having examined the latter, so as to assure ourselves that the ovaries are not prolonged into it, it is cut away, as well as the branchiæ. The orifice of the lateral cavity is then easily disclosed in the *Mytilus* beneath the belly. These preparations are preserved like the other male organs.



SECT. IV.—*RADIATA*.—ENTOZOA.

532. The genital organs of the Cavitary Entozoa are prepared like those of the Annelida; but those of the Parenchymatous present greater difficulty, it being necessary to follow them out with the scalpel through the parenchyma of the body, in the same way that the intestinal canal of the Acephala is traced through the liver. The preparations are preserved like those of the Annelida.

ECHINODERMATA.

533. To see the ovaries of the *Holothuria*, the body has only to be opened along its inferior surface. For those of the *Echinus*, the shell is sawed into two equal portions, as in preparing the digestive canal. Lastly, in *Asterias*, the integuments are removed from the upper part of the body, and the base of the rays. In turning back the strips thus formed, the ovaries are found resting against the lateral parietes.

ACALEPHÆ.

534. The genital organs must be traced like the

other viscera, through the parenchyma of the body by means of a scalpel.

POLYPI.

535. With the exception of somewhat large species, such as the *Actiniæ*, the Polyyps can seldom be dissected, and in the former the whole proceeding is reduced to slitting the body in two along its axis to see the interior of the cavity, and making different cuts in the parenchyma, to see the arrangement of the eggs. Some of the methods, however, employed by Trembley in his curious experiments may be pointed out here.

536. In order to cut the *Hydras* transversely, Trembley placed them in the hollow of his left hand, with a little water, leaving them quite still. These creatures soon began to lengthen out, and while in the state of greatest extension they were cut into two with very fine scissars.

To cut them longitudinally is a more difficult operation, the body being long and narrow. But to succeed, the same observer placed these animals also with a little water in the hand, bringing them afterwards with the point of a brush to the margins of this drop of water. In this state, these animals contracting as much as possible, their body became short, wide, and depressed. Seizing them then between the blades of very fine scissars he cut them lengthways; sometimes for performing this operation, he seized upon the moment when these animals were well fed, and their body being then very swollen and broad, they were readily cut into two.

For replacing these portions of Hydra in the jar full

of water destined for them, he began by covering them with water, and raising them afterwards with the point of a well moistened brush, so as not to tear them.

Each half of the Hydra grew together at its edges, which united thus to form a complete individual; and this re-union took place so rapidly, *that it commonly took but an hour, and even less, for the half of a longitudinally divided Polyp to assume the form of a perfect individual.*

For simply opening the body of a Hydra longitudinally, Trembley caused the animal to contract in his hand, as for cutting it in two, and then making the point of his scissars enter by the mouth and pass out at the other extremity of the body, the latter was slit by closing the instrument.

According to the numerous experiments of this observer the Hydra could even be cut into a great number of pieces, each, or at least the majority, of which became complete individuals. When a number of notches were simply made in the body, so as to divide it into several parts, which still held together, all of these became either heads or tails, and formed a very compound animal.

Lastly, in turning a Hydra inside out, like a glove, the animal continued to live in this state, where the external skin became the internal membrane of the stomach, and *vice versa*.

For performing this latter experiment, Trembley recommends our commencing by giving the animal plenty to eat, so that its body may dilate as much as possible. Placing it then in the hollow of the left hand with a little water, the posterior part is first pressed

slightly, to make the food contained in the cavity advance towards the mouth, and pass partly out of the latter, forcing it thus to dilate considerably. This being done, the bottom of the sac that forms the body is to be pushed with a hog's bristle, cut square at the end, so as to make it pass into the interior; and continuing the operation, it is made to advance towards the mouth, pushing the food before it, and thus forcing the former to dilate, it facilitates the exit of the bottom by this orifice.

A Hydra, thus turned inside out, reverses itself most frequently, so as to recover its primitive and natural condition, but to prevent this Trembley fixed the anterior extremity, by transfixing it as near as possible to the mouth with a very fine hog's bristle. He made a knot beforehand in the bristle, to prevent the animal from disengaging itself, and then placed the latter at the bottom of a glass the knot downwards, so that the body gliding along, could not be unspitted.

To introduce one Hydra into another, so as to graft them together, Trembley gave both of them food. Placing that which was to be *internal* in the hollow of the hand, he made it contract as much as possible; pressing it then slightly with a brush, so as to drive a part of the food it had swallowed out at the mouth, he forced this opening to dilate. Taking next in the right hand a hog's bristle, he passed the large end into the mouth, and pushed it to the bottom of the stomach. Causing afterwards the mouth in the second individual, which was to become the external one, to open also, he thrust in the first, placed at the end of the bristle.

CHAPTER XI.

RESPIRATORY SYSTEM.

SECT. I.—*VERTEBRATA*.—*MAMMALIA*.

537. DISSECTION.—The *lungs* forming two masses, adherent only above within the thoracic cavity, can be easily drawn out without being injured, by removing them together with the trachea, the heart, and mediastinum. In this state their external form and relations can be easily studied, at the same time that, by slight inflation through the trachea, they can be placed in the condition in which they are during inspiration. The air-tubes swell out by this means to their minutest subdivisions, and the whole organ assumes the elasticity of a bladder. Thus filled with air these organs are seen, by their slightly undulated surface, to be sub-divided into a great number of very irregular and compound lobules, which may be often neatly separated by means of a scalpel, especially among the Ruminants, and the *Calf* in particular, where a portion by no means large may be easily isolated for separate inflation. For this purpose, a part forming the extremity of a pulmonic lobe in this animal, where the lobules are particularly distinct, should be chosen, isolated from the rest, and when the bronchial tube passing into it is reached, it is

to be cut at a certain distance above, so as to form a pedicle by which the small lobule can be inflated. But care must be taken not to push the pipe in too far, for fear of injuring the internal walls of the bronchi, and making apertures which would communicate with the spaces forming the intervals of the lobules, and by which the air would escape. Thus the inflation of an entire lung, which is very difficult, may be dispensed with, by confining ourselves simply to a very small portion of the organ. After having dried the lobule thus distended with air, slices are raised from it by means of a well-cutting instrument, such as a razor, to see the internal structure of this viscus, when the walls of the cells, stiff by drying, maintain their form perfectly, and admit of their arrangement being distinctly seen, and how they communicate with the terminal bronchial canals; the points also, where the cellules adhere to the external membrane of this organ, are particularly well recognised upon the most superficial lamellæ of the lung in the *Calf*.

538. To those who are acquainted with the structure of the parenchyma of the lung, it is clear, that this viscus cannot be injected by the bronchi with the view of having an internal mould, seeing that the mass, supposing it perfectly succeeded, would fill the cells, and form but a shapeless body, where it would be impossible to distinguish the least thing. If, on the contrary, it is wished to know the arrangement of the principal bronchi, these canals should be injected with a corroding mass, and best with a fusible metal, but without emptying the lungs previously of air, so that the cellules

may not be filled, and the parenchyma will be destroyed afterwards by maceration.

539. Preparations of the *larynx* are simply made with a scalpel. After having freed this apparatus from the neighbouring organs, and examined its relations with the tongue, os hyoides, pharynx, and trachea, it is removed in a single mass with the latter, to be examined separately. Every thing that does not enter into the composition of this apparatus is to be successively detached, excepting the hyoid bone, which serves as a support to it, and the upper end of the trachea which is its continuation. It is fixed upon a cork plate, the lateral part of the hyoid bone cut on one side, as well as the corresponding half of the thyroid cartilage, which must not, however, be cut so near the median line, as to destroy the lateral ligaments and chordæ vocales. By this all the muscles are exposed, and the rima glottidis seen extended from the thyroid to the arytenoid cartilages. In raising successively the muscles, the cartilages and their ligaments are entirely uncovered; and lastly, by cutting away also on the same side half the cricoid cartilage and trachea, an internal profile of the larynx is obtained.

540. PRESERVATION.—The lung may be preserved dry or in fluid. This last method is preferable for seeing the general form of the organ, and its relations with other parts, as it becomes much out of shape by drying. The first is better adapted for showing the cellular structure of this organ. When the preparation is to be preserved in a dry state, an alcoholic solution of corrosive sublimate must be previously injected by the bronchi, to

keep it from insects ; and it is then emptied immediately afterwards, blown into, and turned upside down, the trachea below, to cause the rest of the liquid to run out. When all of it is accumulated in the trachea, the preparation is taken up and blown into afresh to distend the cells, and then put to dry. It is true that the air being susceptible of compression by the contracting of the parenchyma, the lung is much deformed, but not sufficiently to prevent our seeing the arrangement of the cells. If a portion of lung is not bulky, it can be injected with mercury, and suspended by the bronchus until the preparation is dry, and then the metal poured out ; but these means are not equal to distension by air.

541. Preparations of the larynx along with the muscles are preserved in fluid. As to the cartilages alone, they may be preserved dry if belonging to large animals, where they have sufficient thickness not to shrivel up much ; among small ones, on the contrary, they deform so much in drying that scarcely anything can be recognised. By placing them, however, for some hours in water, they regain, by swelling out, their primitive form.

AVES.

542. To prepare the *lungs* and their appendages, the muscles of the anterior part of the thorax must be removed in succession from one side, and after having disarticulated the wing so that it may not be in the way, some parts of the antero-lateral cell are already perceived between the deep muscles. Removing next the corresponding half also of the furcular and coracoid

bones, this last cavity is widely opened. The air pouches, placed behind it, are opened successively by removing one by one from before backwards the sternal ribs, as well as the corresponding part of the sternum as far as the keel, to see how the transverse partitions, which separate these cavities, terminate in the parietes of the thorax and abdomen.

After having well distinguished the position and relations of these pouches, all the viscera are to be carefully drawn out, so as not to injure the median partitions of the opposite side, which are examined by degrees as they are disclosed; and lastly, the entire sternum as well as the ribs still remaining are removed, so as to have but the upper half of the thorax, to which the lung is moulded.

M. Straus-Durckheim does not advise injecting the bronchi, as the matter would spread everywhere. Neither can the lung be prepared any better by dessication, since it cannot be inflated; and the only method that can be employed is direct dissection. For this it is sufficient to cut slices in different directions, and place them in water, when the parenchyma of the viscous swells out, assumes its natural appearance, and the open bronchial tubes are perfectly well seen. The pulmonary vessels may also be injected previously, with a corroding mass, and the specimen afterwards dried.

543. Preparations of the two *larynges* of Birds are extremely easy, especially those of the interior, which have only to be disclosed for every part to be found neatly arranged. As to the upper one, it is examined at the same time as the tongue and hyoid bone to which it

belongs ; by removing the mucous membrane from the mouth, the subjacent cartilages with their muscles are exposed.

These preparations are preserved in fluid, when they support muscles, or in the dry state, when there are only cartilages.

REPTILIA.

544. The lungs of Reptiles can be very well preserved dry, after being distended with air, but they cannot be injected from the bronchi, which are not prolonged into their interior. To give more consistence to the parietes of the cells the blood vessels may be injected, and the lungs afterwards distended, so that during cooling, the vessels may preserve their expansion. For this, it will be as well to employ size, as it fixes less rapidly than the greasy injections. The best way, however, is to preserve the organs by placing them in fluid.

CHELONIA.

545. For preparing the respiratory organs of the Chelonians, the body, as for all others, must be opened from below, in the manner indicated in treating of the muscles. The parts belonging to the anterior extremities, the heart and its appendages, then the liver, are to be removed successively, and the lungs are found in the form of two great sacs placed above the two lobes of the latter, extending over more than the anterior half of the carapax.

The *larynx* is preserved like that of Birds and Reptiles.

The respiratory organs generally are preserved by the same methods as their analogues in the above two classes.

PISCES.

546. DISSECTION.—The branchiæ of Fishes, as those of Reptiles, do not require any preparation for being studied, except injecting their blood vessels, as will be indicated in the following chapter.

547. PRESERVATION.—The preparations can be most frequently preserved dry, being sustained by osseous pieces, which keep them in place. These organs may be simply dried in the air without any previous trouble; or, in order that their lamellæ may not curl up, they can be placed in a jar full of fine and well washed sand, and as dry as possible, which being dropped between the lamellæ keeps them properly separated, and prevents their folding. When the whole is well dried, the sand is poured out, and the branchiæ have preserved their natural forms.

SECT. II.—ARTICULATA.—ANNELIDA.

548. THE branchiæ of the Annelidans are not susceptible of any preparation, and are to be dissected with the integument.

MYRIAPODA.

549. To see simply the distribution of the tracheæ

the body may be either opened from above or the side, by slitting up the middle of the segments. But as one part of them, holding to the superior arcs, must necessarily be removed when the dorsal surface is opened, it is more convenient to dissect these vessels by the internal profile, when it is wished to see them all in their place. These vessels, naturally filled with air, derive thence a beautiful metallic white colour, like mother-o'-pearl, or as if they were injected with mercury, which produces a very pretty effect upon the darker ground of the other organs upon which they run. The tracheæ have no need therefore of being injected previously, when examined in a fresh animal; but in those which have remained long in fluid, the latter penetrating at length the interior of these vessels, causes the above mentioned silvery colour to disappear by maceration, and the tracheæ then present only a greyish tint, like the other organs, and it is then very difficult also to trace them in dissections. These vessels, being generally very fine, it is difficult likewise to inject them, which may be nevertheless done, either by the stigmata or the great longitudinal trunks; but it rarely succeeds, and when even they are filled with injection, the effect produced is never so good as that presented by these vessels in their natural state. It is advisable, therefore, never to try this operation upon the common species, which can be had fresh.

550. The animals, upon which it is wished to study the tracheæ, may be killed by plunging them some minutes in alcohol, which penetrates only into the largest tracheal trunks; but it is better to asphyxiate them in vapour of ether, or by placing a small drop of ether, or

of essential rectified oil upon the stigmata. It stops up at first these apertures: the animal dies at once asphyxiated, and the oil evaporating directly afterwards, leaves the tracheæ in their natural state. This method can be very well employed for killing Insects, to be preserved in collections, without injury.

The preparations of the tracheæ cannot be preserved otherwise than dried and fastened on slips of glass, as these vessels become indistinct in fluid.

INSECTA.

551. The tracheæ of Insects are prepared exactly like those of the Myriapods, and can be injected with as little success, the work, when done, being always very imperfect. If, therefore, fresh individuals are at our disposal for this kind of research, it is far better to try and prepare these vessels empty. M. Straus-Durckheim has succeeded in this manner, tracing the tracheæ to ramifications not the $\frac{1}{250}$ th of an inch in diameter.

In cutting or tearing the tracheæ across, the spiral thread can be easily unrolled by traction, from between its two membranous coats, and the latter seen separately. The most internal, or mucous, may be very easily disclosed in the tracheæ at their origin, and a portion of it is met with also upon the cast integuments of larvæ, where it has peeled off with the skin, to which it remains fixed.

CRUSTACEA.

552. The branchiæ of Crustaceans, being always more or less detached, can be very well seen on the en-

tire animal, and require no preparation. As to the arrangement of the blood vessels, forming the arteries and branchial veins, it will be pointed out in treating of the circulatory system, and the method of injecting them.

553. For counting the number of rapid pulsations of the branchiæ M. Straus-Durckheim employs a method, which according to him, has succeeded well. He makes, with the hand holding a pencil between the fingers, small vertical movements isochronous with the pulsations of the branchiæ, which is sufficiently easy when practised a little, and at each lowering makes a small mark upon the paper with the pencil. Counting afterwards the number of marks made in a minute, he finds, ordinarily, that there is little difference in a series of observations made successively upon the same animal. The branchiæ can be very well preserved in the dry state, although they often contract much, and to prevent them from becoming too much distorted, the sand may be employed as for the branchiæ of Fishes.

The branchial lamellæ of the *Limuli* are scarcely susceptible of any preparation, except drying, for preserving them. Their pulmonary vein is disclosed by cutting a small strip of integument from the upper border of the extremities which support them, and under this is immediately perceived the vessel alluded to, passing like these members from without, inwards, and increasing in calibre.

ARACHNIDA.

554. The lungs of the Araneidans may be examined either by removing from within the cartilaginous plates,

which cover the pouches which enclose them, or by removing the lips of the air holes. In opening the bag the layers of pulmonary lamellæ are disclosed at once, and it is easy to be convinced that each is entirely free, holding only by its lower border, and that they form so many small compressed sacs. For this purpose they have only to be distended by inflation with a bent blow pipe. In bringing these plates under the microscope, it will be seen that their texture is slightly horny, much resembling that of the tracheæ, but without a spiral thread.

The air tubes of the *Holetrans*, difficult to perceive, from the extreme smallness of these animals, should be prepared like those of Insects.

These respiratory organs may be preserved dry, or in fluid.

SECT. III.—*MOLLUSCA*.—*CEPHALOPODA*.

555. To see the branchiæ, the visceral sac must be opened longitudinally along its inferior or ventral surface. In other respects they cannot be prepared, except by injecting their branchial artery and vein, of which mention will be made in the following chapter.

After having exposed them by removing the parts of the sac to which they are unadherent, they are to be preserved in fluid.

PTEROPODA.

556. Their respiratory organs are not susceptible of any preparation.

GASTEROPODA.

557. DISSECTION. — The respiratory cavity of the Pulmonea is opened by slitting it up from the pneostome, but for this purpose the animal must be quite dead and extended which is obtained by drowning them in the manner pointed out in the chapter upon their muscles, for so long as there remains any irritability, or least trace of life, it contracts so much, that little can be seen of their entirely compressed and distorted pulmonary cavity.

For the *Limax* and approximate genera, whose shell is internal, the capsule is at first opened by removing a part of the mantle, as is pointed out in the paragraph relating to the preparations of the solid parts of these animals. The roof of the pulmonary cavity being thus exposed, it is slit transversely in front of the "gland of the viscosity," which is distinguished by its yellow colour, by entering the blunt point of the scissars in at the pneostome to beyond the median line. The same membrane is also slit from before backwards, at a little distance to the right of this line, so as not to injure the gland. In making these incisions care must be taken to lift up the layer to be slit, and not to plunge the instrument in too deep, for fear of cutting the floor of this cavity. Turning back then the two strips of the roof, the principal branches of the pulmonary vessels, which are remarked from their prominence, will be easily seen. After having recognised the position of the pericardium, the upper part of the respiratory cavity covering it is also slit, so as to see the pulmo-

nary veins penetrating into the auricle, the largest trunks of which are placed in the superior wall of the lung, and the arteries in the circumference. To recognise these vessels well, the whole upper part of the pulmonary cavity should be removed in one piece, to see this part from its inferior surface, upon which they ramify, and the cavity had better still be opened from below.

558. The empty pulmonary vessels are very well seen in the *Helix*, by simply removing the shell, and are injected from the vena cava, situated in the superior cushion of the spires of the herniary sac, and in *Limax* along the two sides within the parietes of the body. For this, see the chapter relating to the circulatory organs.

559. The Pectinibranchiata, Tubulibranchiata and Scutibranchiata having their branchiæ internal, they are disclosed either by slitting the cavity from its orifice, or tracing the syphon, or making an opening in its cavity, after having removed a part of the shell.

As to the species of which the branchiæ are more or less external, such as the Nudibranchiata, Inferobranchiata, Heteropoda, Tectibranchiata and Cyclobranchiata, there are no other preparations to be made but injecting these organs.

560. PRESERVATION.—The respiratory organs of the Gasteropoda are preserved in fluid, like all their other soft parts.

ACEPHALA.

561. To expose the branchiæ of the Ostracodermata,

it is sufficient to remove with precaution one of the two valves by the methods indicated in the chapter upon their muscles, and turn down towards the back, or remove entirely, the corresponding part of the mantle. The sacs formed by each lamina can be easily inflated, and after having injected these organs to see the arrangement of their vessels, some fragments can be placed upon a plate of glass, and immersed in water, when these laminæ extend perfectly on the least traction. These preparations upon glass should be preserved dry, after having washed them over with sublimate; and as they are extremely delicate, they should be placed between two glasses fastened one upon the other.

~~~~~

SECT. IV.—*RADIATA*.—ECHINODERMATA.

562. THE respiratory organ of the *Holothuria* is prepared by opening the body throughout its whole length, from the inferior surface.

The *Echini* are sawn transversely, as for seeing the other viscera, and the small orifices of the respiratory tubes, are disclosed within between the parts of the lantern, and may be easily injected. But to expose them completely, the lantern must be removed. In order to see the external tubes, the spines and small feet encircling the mouth are to be first removed. In the *Asterias*, it is sufficient to cut with the slice a part of the integument, penetrating with it into the cavity of the body, and to transport the piece thus detached under a lens, to examine the small tubes and their internal orifices.

## CHAPTER XII.

---

 CIRCULATORY SYSTEM.
 

---

SECT. I.—*VERTEBRATA*.—*MAMMALIA*.

563. DISSECTION.—For preparing the heart of the *Mammalia*, the sternum, as well as the costal cartilages must be first of all cautiously removed, so as not to injure the part of the pericardium which corresponds to the apex of that bone, this bag being often adherent to it, as is the case in Man. The pericardium being exposed, its position and relations are examined *in situ* in the mediastinum. To see it in detail, it is removed with the heart and lungs, as well as a portion of the diaphragm, to which the pericardium is adherent in many animals.

After having divested the pericardium of its surrounding parts, such as the mediastinum and lungs, preserving however the origins of the great vessels to which it adheres, it is inflated so as to detach well the heart which is placed in its interior, by piercing a very small opening in an oblique direction through its two coats, so that the external may be at some distance from the internal orifice. The tube of a blow-pipe is introduced by this canal, and blown into, and the instrument being afterwards withdrawn, the lips of the

canal come together and prevent the air from getting out.

This sac being thus distended, the strips of pleura which cover it and other adherent parts are removed, care being always taken to handle gently the vascular trunks which enter or make their exit, and especially to dissect with care those parts of them with which the membrane of the pericardium is continuous.

When its parts have been studied, and especially its two coats, this sac is to be slit open to disclose the heart.

564. After having well recognised the external parts of the heart, the disposition of the ventricles, that of the auricles and their appendages, as well as the origin of the vascular trunks and their continuity with the pericardium, the heart is taken out with its appendages to be examined more at ease; each of its four cavities is opened, by making apertures in their walls sufficiently large to see their interior.

In the *right auricle* an incision should be made in the largest portion of its width, parallel with, and at a little distance from the free border which rests upon the ventricle. In the middle of this slit should be made a second nearly perpendicular thereto, and prolonged to the upper part of the auricle. By separating then the two triangular strips, the whole interior of this cavity may be easily seen, without injuring any important part.

The *left auricle* is to be proceeded with in the same manner.

565 As to the *ventricles*, many anatomists recom-

mend removing a triangular piece of their parietes, circumscribed by three cuts; in other words, by following upon that of the right side a line parallel with the groove which marks out the interventricular septum; the second along the free border of the auricle; and the third by joining the extremities of the two first, this surface of the ventricle not presenting any vessel to be meddled with; but there is a risk of cutting the fleshy columns which support the auriculo-ventricular valves; and M. Straus-Durckheim prefers opening this ventricle, like its auricle, by two incisions in the form of a T, of which one is parallel to the upper border, and at a little distance from it; and the second perpendicular to the first, that is, carried from its middle to the apex of the heart. After having made the first incision, by separating the lips, it may be very well seen what is the position of the valves and carneæ columnæ, so as not to injure them by the second. This being also done, the two strips are folded down so as to open the cavity widely, and, if proper, some parts of the parietes may be afterwards removed. The left ventricle will be opened in exactly the same manner.

566. Apertures may be also made in the vessels provided with valves, that is to say, in the aorta, venæ cavæ, and others, if occasion requires. These openings should be made as is judged most convenient, after having examined the parts through those made in the four great cavities. But it will be always best to make at first a small opening at a little distance from the orifice of the vessel, and to enlarge it as it is found convenient.

567. As to the *structure* of the heart, it is difficult to

recognise it well on this organ in a fresh state, and it must for that purpose undergo a previous preparation, by which its fibres become more distinct. By soaking it in alcohol for some weeks, its fibres acquire more consistence, become harder, more apparent, but do not separate. By boiling it, on the other hand, for half an hour, as proposed by Stenon, and practised long before by Massa upon the tongue, the cellular tissue which unites the fibres dissolves, and the latter separate at the same time that they become dryer, and therefore very distinct. To dissect afterwards this viscous Winslow recommends detaching in Man the two auricles, and cutting the aorta and pulmonary artery an inch distant from their origin, and after having boiled them, to make two circular incisions a line in depth, one at the base, another at the apex, and a third longitudinal; by following the interventricular groove, to raise next the external fibres, which serve as envelopes to the heart, and separate the two ventricles, taking care to handle the fibres of the right gently, as their surface is very thin and easily torn. In this manner the two ventricles will be separated.

Other anatomists have since employed the preparation of Massa and Stenon, but by pursuing different methods of dissection. It has been also recommended to boil the heart in vinegar, or let it soak for some months in a mixture of alcohol and essence of turpentine, or better still, in weak nitric acid; but all these means have no advantage over boiling in ordinary water, which is at once easier and less expensive.

568. To study the tissue of the arteries, as large a



trunk as possible is to be chosen, and slit longitudinally, to be spread out on a plate of cork and fastened with pins, and dissected under water, by removing successively its different coats. As to the serous, it is examined from the internal surface, so as to recognise how it forms projections and valves.

Preparations of the tissue of the veins are made absolutely like those of arteries. But to see better the internal valves, one of these vessels is removed for the extent of about four to eight inches, leaving the ends with all their branches; the blood contained in them is well cleaned out, by washing them several times in warm water, and when the latter passes out limpid the cut branches are tied, and the trunk itself at the end nearest the heart; the vessel is inflated from the other extremity, closed by a ligature, and dried. In opening it afterwards longitudinally, the valves are seen in their places and distended.

569. The arteries not having valves to prevent the masses from running in every direction, may be easily injected by the branches, but large trunks are chosen in preference, from which the liquid spreads more equally throughout. Ordinary injections are made most frequently from the aorta, or the heart, in which case the jet follows the same direction as the blood. The heart is first of all disclosed by removing the portion of the sternum beneath which it is situated, for which purpose a strong block is placed transversely under the back of the subject, if a human body, and a longitudinal incision is made in the integuments upon either side the sternum, from the articulation of the second rib to that of the

sixth, the portion of skin included in these incisions being removed, so as to denude the sternum. The ribs, of which the heads are exposed, are then cut near to their sternal articulations, so as not to wound the internal mammary arteries placed beneath the costal cartilages, and the corresponding portion of sternum is afterwards removed by cutting it transversely by means of the bone nippers (§ 70). The pericardium being disclosed, it is opened, and the aorta and pulmonary artery found side by side, and distinguished at once by the thickness of their parietes. These two vessels are separated with the finger, so that the aorta can be encircled with a double ligature: a longitudinal incision is made in this vessel, as near as possible to its exit from the heart, and the pipe of the injecting apparatus introduced, which is fixed by means of two circular bands receiving between them the rim surrounding it, so that the vessel does not slip off.

When the subject is a small animal, the heart of which can be easily ligatured, it is better to inject from the apex of the left ventricle, directing the canula towards the aortic orifice, so as not to get the auriculo-ventricular valves before it, which might turn the jet and make it pass into the auricle, and the ligatures are then placed upon the middle of the heart itself.

570. Injections from the ventricle or the transverse arch of the aorta have this great inconvenience, that the chest must be opened largely, and so great a number of vessels consequently cut that it is impossible to tie them all, so that on the one hand the injection is lost, and on the other the heart and its principal trunks gene-

rally found injured or destroyed. It is better therefore to make injections from the large arteries, those which can be easiest reached, as the carotids, brachial, crural, and even smaller trunks, as the caudal.

The common carotids being placed deep between the muscles, it is difficult enough to get at them in animals with a short neck, the head and shoulders being in the way, but it is more easy in long necked species. The lateral part of the cervical region is denuded, the muscles separated one from the other without cutting, but simply by displacing; and the artery is found in front of the transverse apophyses of the vertebræ, between the sterno-mastoid and sterno-hyoid muscles within, and partly behind the jugular vein, which care must be taken not to open, lest the blood spread out over the preparation. The artery is disclosed by separating with hooks the first of the two muscles just named, and a small slit made longitudinally in the vessel to insert the canula of the syringe or pump, which is directed as may be wished, either towards the head or the thorax.

For injecting a vessel, an aperture, as has been said, must be contrived in the form of a slit, and not by cutting transversely, because it is more easy then to introduce the canula.

571. When it is wished to inject from the brachial artery, the subject must be laid upon its back, the pectoral muscles cut in the hollow of the axilla, but with great precaution, so as not to injure the numerous vessels found in this region. By this means the arm can be easily separated to get at the artery which is found

between the tendon of the pectoralis major, and that of the latissimus dorsi and teres major united, and lower down, behind the internal border of the biceps. But the better plan for injecting the arterial system from its branches, is to do it from the crural trunks at their exit from the pelvis, where they are nearly sub-cutaneous. The thighs of the subject are separated for this purpose, kept so, and Poupart's ligament disclosed, taking care also not to wound the vessels of this region. The artery is met with behind the sartorius, passing from beneath the femoral arch downwards towards the angle formed by that muscle with the adductor longus and the internal rectus; the fat is removed which fills that space, and the vessel being exposed is injected.

572. Among those Mammalia which have a rather large tail, the caudal artery situated beneath in the median line, and being the true continuation of the trunk of the aorta, may be also injected. By this the whole arterial system is filled, but as this vessel is generally weak, the subject must be well heated, so that the mass should not set too quickly, and that it may have time to enter into the minutest parts.

When a partial injection of an organ is wanted, it is natural to place the canula in the vessel which directly conducts the blood, and tie all the branches by which the matter could escape, or if this is too difficult, a canula is placed in the trunk which furnishes this branch, and ligatures placed upon all the others which arise from it, so as not to fill uselessly several other parts.

573. An organ after having been isolated, (which is

necessary to be done in certain cases, according to the end proposed) may be thus injected, but it is much better, if possible, to inject it *in situ*, since in that way very few of the vessels by which the matter could escape are opened, while at the same time the neighbouring parts surrounding that on which it is wished more particularly to operate, preserve it from the extravasations which usually take place upon the surface, and which always soil the parts, and have to be removed with the useless organs which they cover.

574. The arteries being generally empty in dead animals, the injecting mass experiences no resistance beyond what the gases contained in these vessels oppose to it, and penetrates easily into the smallest arteries, by pushing these gases into the venous radicles; but, as the mass itself varies according to the end proposed, it cannot always traverse very delicate vessels. For careful injections, therefore, two different matters are employed, of which the first introduced is the most fluid, more divisible therefore, and capable of penetrating into the finest vessels; it should form nearly a third or a quarter of the total mass, while the second, composed of grosser and less divisible substances, forms the remainder, and filling the large trunks pushes the first before it.

575. The injection of the veins is much more difficult than that of the arteries; on the one hand, from the numerous valves which intersect their cavity not allowing the mass to be introduced from the large trunks, so that it is impossible to fill a body completely at once, and push the matter to the venous radicles, but one is forced to direct the injection from the branches towards

the trunks, which leaves empty all the portion placed beyond the point of operation. It happens, however, that by reason of the numerous anastomoses which exist between these vessels, other parts of the body are still found filled, even when the injection has only been impelled into a single branch.

The second difficulty which the veins present, arises from their walls not being so resisting as those of the arteries, and rupturing more readily; hence great precautions are required on the part of the operator, and especially a very delicate hand to moderate, according as is required, the force employed.

Lastly, a third difficulty proceeds from the presence of blood which gorges them in the dead body, and opposes the entrance of the injection. For filling these vessels, the body must be submitted to some previous preparation.

576. A subject destined for injection should be as young as possible, the walls of the vessels being generally more resisting and elastic than in the old, and the capillaries of the arteries also more developed. As to the veins, it is true their calibre is larger in aged subjects, but this advantage is trifling in comparison with the inconvenience resulting from the febleness of the coats of these vessels, which rupture more easily than in young subjects, whereby the operation either fails entirely, or the preparation is, at least, injured.

A rather lean individual should be chosen in preference, because the fat, by masking the vessels, forms an obstacle to our progress in the dissection, and it is precisely about the vessels, and especially the

veins, that these adipose masses more particularly accumulate.

The subject ought to have been dead only a short time, for putrefaction rapidly alters the texture of the vessels, especially of the veins, which then rupture more readily. The best plan is to have the body of an animal recently killed, the blood of which still warm and fluid, may be readily evacuated by placing the body in a bath of a temperature from  $100^{\circ}$  to  $106^{\circ}$  Fahr., in which it is left, on the one hand, until the blood may have partly trickled out by the veins which have been opened for this purpose, and on the other, until the body, stiff at first, has become supple; the injecting matter then runs more easily than during the contraction, which commonly follows death, and when the vessels are more or less compressed.

577. Individuals kept a long time in preserving fluid, such as alcohol, which condenses the tissues, can serve but little for fine injections, the vessels being narrow and gorged with fluid and coagulated blood. It may still, however, be tried to inject the arteries by choosing the mass according to the fluid the subject has remained in. If it is alcohol, resinous matters may be injected, but albumen or milk will succeed better.

The arteries being generally empty after death can be injected to their finest subdivisions, without previous preparation. But it is not so with the veins, in which all the blood accumulates, and from which they must be at least partly freed. It is recommended for this purpose to place the body in a bath of a temperature from

100° to 106° Fahr., which is nearly the heat of the blood in the living state, to leave it there about five or six hours, and even more for a body of the size of a Man, so that it does not get cool, and the injection may not fix too quickly, and may penetrate more readily into the capillaries.

When, on the contrary, a body is only to be injected for the study of the principal vessels it is useless to take this care, the mass always going sufficiently far to fill the vessels designated by special names in elementary works on anatomy.

578. For fine injections of the veins, it will be especially advantageous for the subject to have been dead but a short time, and that the blood be warm and liquid, so that in placing the body in a bath, this fluid may be more easily evacuated. But in opening only the veins by which it is wished to inject, it is evident that it can be only the distal branches which empty themselves, whilst those to be injected remain gorged with their blood, and to make it run out the trunks must necessarily be opened, by which it can do so, and especially the right side of the heart; the trickling out will be then produced, either by the slow contraction exercised by different organs upon all sides of the vessels, or by pressing the parts gently, and at several intervals, proceeding from the extremities towards the heart. These compressions, acting upon the veins, push the blood forward.

Warm water may also be tried for injecting the veins with, to drive out the blood, and is also recommended because the clots formed by the latter oppose



an obstacle to the mass, and the water may be driven out afterwards by blowing in air.

The best plan of emptying the veins, at least partly, is to cause the animal to die of hemorrhage, by opening the principal veins from which it is wished to inject.

579. The veins of Man are generally injected by the superficial lateral internal and external branches of the foot and hand, or by the temporal frontal veins, &c.

580. It is necessary also to place a pipe in the superior and inferior mesenteric veins, splenic, coronary, stomachic, and cystic, branches of the vena porta, forming a system apart from the rest, which are distributed to the liver like arteries. For that purpose, a crucial incision, from three to four inches long in Man, is made in the parietes of the abdomen, in the part which corresponds beneath the umbilicus to the abdominal aponeurosis, on the side of the rectus muscle. Through this opening a loop of intestines should be drawn out with its corresponding portion of mesentery, and the largest venous branch chosen from upon the latter, to introduce the canula.

581. When the subject has remained some hours in the warm bath, and the veins are disgorged, the injection of the arteries is first commenced with. If the operation succeeds well, that is to say, fills the capillaries, it is seldom that the mass does not pass in many places into the radicles of the veins, and frequently even into their branches, which so anastomose, that being filled thus by injection from the arteries, their arrangement may be easily studied. If, on the contrary, the veins are first injected, it often happens that the blood, collected in the radicles by the communication of their

numerous inosculating branches, opposes the entrance afterwards of the injection coming from the arteries.

As soon as the arteries are filled, the injection of the veins is proceeded with, commencing in the vena porta. This operation being done, the subject is left to rest for some minutes, to be placed afterwards in a cold bath, or in the open air, if its temperature is low, so as to fix rapidly the matter injected. By thus leaving it a few minutes before cooling, the mass, still liquid, penetrates of itself further into the capillaries, after the effort of the syringe has ceased; this being the effect of the elasticity of all the parts, and especially of the vessels, which having been forcibly distended, recover themselves, and propel the injected matter further on.

The body being gently heated throughout, the matter injected remains, if not liquid, at least of less consistence, as long as the body does not cool, and a risk is therefore run of seeing it pour out of the vessels, when cut, and soil the preparation, if the dissection of the subject be too soon commenced; and it had better be deferred until the injection has set.

582. Different instruments are used for injecting the vessels, which have been described in the first part of this work. They may be distinguished into two kinds; those which serve for coarse or common injections, and those for small or fine injections. It remains to show here their application.

583. The instrument most generally used in the schools is the *syringe of Swammerdam* (§ 21), the canula of which is fitted on the body of the pump, either by friction or by a bayonet catch.

The former method, as being the easiest, and causing less derangement in the vessels, is to be preferred.

When the subject is ready for injection, the canula is placed in the vessel upon which it is wished to operate, and which has been disclosed. For this purpose, a longitudinal incision is made in the vessel, sufficient to enable us to introduce the canula, but the vessel must not be cut crossways, especially if a vein, the walls of which would collapse; the arteries, on the contrary, the aperture remaining open, may be cut transversely, if its position requires it, since in this case the canula may be more easily introduced, but by making a longitudinal opening, there is always greater facility in fixing it. Before introducing the canula, three waxed threads are passed under large trunks, and two only beneath the small. One of the lips of the slit is then laid hold of with forceps, is drawn slightly aside, and the tube of the canula introduced by the other hand into it, and pushed in to the extent of a few lines beyond its point. By means of a probe, it is ascertained that it is in the cavity of the vessel, and not between its two coats; and this being clearly made out, the vessel is attached to the canula by means of two ligatures, if there are three grooves on the canula, receiving the circular ridge between them, and if only two, a single ligature is placed behind the latter. The third serves to tie the vessel after injection.

The canulas being often very heavy, and dragging the vessels considerably, it is well to support them by a string attached to a hook.

584. This part of the instrument being introduced,

the operation is proceeded with, the substance to be used having been prepared beforehand, as indicated in Chap. III, Sect. 1, upon injecting compositions. The quantity employed, varying according to the size of the animal, cannot be pointed out for each; but it is sufficient to know it in an approximative manner, since more ought always to be prepared than is absolutely necessary. According to Rudolphi, there may be reckoned about 28 to 30 lbs. of blood in a human body of ordinary size,  $\frac{4}{9}$ ths of which are arterial, and  $\frac{5}{9}$ ths venous, which would be very nearly 14 pints, 6 of the former and 8 of the latter; but in ordinary injections there must be less matter than this, the substances composing them not penetrating generally into the capillary vessels, and in fact scarcely 3 pints of substance are reckoned for the arteries, and  $2\frac{1}{2}$  only for the veins, the blood filling a great part of the latter, and their small branches being but rarely injected; but a good *third* more than is wanted ought always to be prepared, so as to be ready at hand.

In ordinary injections well made, the above quantities may be much exceeded.

585. The quantity required for animals of different sizes, can be deduced from that already indicated for Man, by taking an average of the measure by the weight of the body, which should be to that of the matter injected as 17 to 1 for the arteries, and 21 to 1 for the veins. The substance used should be heated some degrees above its perfect fluidity, so as not to set too quickly, and it should not be too hot for fear of *crisping* the vessels, which happens, however, only where much wax or

resin enters into the substance, or fusible metal; matters which hardly melt below a temperature of 186° Fahr. for wax, 150° Fahr. for fusible metal, and about 250° Fahr. for common resins.

586. The injecting apparatus should be previously heated to the same degree, or even a little more, so as not to cool too much during the operation. If the syringe is employed, it is to be filled with injection by drawing up the piston, and having been satisfied that it contains no air, the canula is mounted upon it, and attached by two strings, and the piston pushed down with an equable force and without shocks, as in that case the canula would easily cause a rupture of the vessel. Attention should be also well paid towards moderating the force employed upon the first resistance, which is often due to coagulated matter stopping up the canula, or in the large vessels. In the first case, if the resistance continues, the syringe may be removed, and the canula cleaned by means of a probe, and the injection afterwards proceeded with; but when the obstacle is found in the vessels, it is more difficult to remedy; it can be removed sometimes by pushing in the probe as far as possible. This resistance occurs also more particularly towards the end of the operation, when the matter, after having filled the large branches, experiences some difficulty in penetrating the small ones, and especially the capillaries. It is then necessary to stop a moment, to allow the greatly distended vessels time to recover themselves by their elasticity, and push the matter filling them further on. By then slightly pressing down the piston, it may be ascertained whether the injection has

been carried further on beyond the point of resistance, and if the latter recommences, it must be stopped again, until it remains constant, when the operation is ended. By a little practice the force required to be used is easily learnt. It can be readily seen from external appearances if the injection has succeeded, especially in the arteries, when the fine membranes, such as the mucous membrane of the lips and the conjunctiva, are coloured, and when the skin is generally distended and assumes the tint of the matter filling its superficial capillaries.

587. In injecting the veins, care should be particularly taken not to use too much force, as these vessels, being far more extensible than the arteries, dilate considerably, and take on a larger diameter than during life, which might lead persons, seeing them thus swollen, to think it was their true calibre.

If a sudden diminution in the resistance is felt during the operation, it indicates that some vessel of considerable size is ruptured, and the process must be stopped forthwith, if the accident cannot be remedied at once by placing a ligature on the point of laceration, for otherwise all the matter pushed into the vessels would escape by this opening. If that happens towards the beginning of the operation, in a somewhat large vessel upon which a ligature cannot be applied, the injection has failed.

588. The method above indicated is that generally employed, and is sufficient for coarse injections, but it is liable to sundry inconveniences, which it is as well to guard against in using fine injections. By adapting, directly, the body of the syringe to the canula, it is im-

possible to keep the instrument immoveable by the hands only, and the least trembling or shock, by being transmitted from the canula to the vessel may cause ruptures. In employing however an intermediate flexible tube, as described in treating of injecting instruments (¶ 26); not only are these slight displacements of the syringe which can hardly be avoided unfelt, but this tube having more or less length, admits of the end of the syringe being rested either against the edge of the trough in which the subject is placed, or against the table, or any other resisting body, which completely destroys the vibration. This flexible tube should be previously heated and screwed upon the syringe after it has been filled, and before adjusting the other extremity to the canula, some of the injection should be driven out to expel the air.

589. Another improvement which has been added to the syringe, has been, to place it in an apparatus already described (¶ 27), where the piston is pushed down by means of a handle. It is true, that the piston of the ordinary syringe can be pushed with more force and regularity, but the former is not really necessary except in injecting animals of considerable size, such as *horses* and *oxen*, and would, on the contrary, be injurious to smaller subjects. It has besides another disadvantage, that of not allowing of any resistance to the passage of the injection, either from obstacles retarding its flow, or from friction in penetrating the small vessels, being felt with sufficient ease, and the operator is also not well apprised of the diminution in resistance caused by the rupture of a vessel, while with the pump he feels the least

difficulty in the flow of the mass, and can at the same time continue the operation without interruption.

590. For injecting very delicate vessels upon tolerably large bodies, the most convenient apparatus is the injectory (§ 33), and, as its pipes being very fine should remain fixed to the flexible tube, they are to be inserted in the vessels only when just about to be used, and in case of the latter being too delicate to be slit for introducing such small canulas, they should be of very fine drawn glass, or better still of steel, so that they may enter by simple puncture, and in an oblique direction, without transfixing the vessel; and being once within its cavity, they are held firm in one hand, whilst the other opens the cock, which gives exit to the injection. If the vessel has been transpierced, or the tube inadvertently placed upon one side of it, it is instantly perceived by the mass formed in front of the small tube.

A method of making very penetrating injections, and recommended by Homberg, but which is seldom employed, except for very small objects, consists in placing the latter under the pneumatic bell (§ 40), after having opened the large trunks for the air contained in them to escape, for which purpose the right side of the heart, especially where the veins terminate, should be opened. A tube, traversing the sides of the jar, and dipping into the injection, is then placed in the vessel, and as the vacuum forms, so by degrees the mass is drawn up, and fills the smallest arteries.

591. This receiver may be also used for emptying the arteries of large animals before injection, so that the gas may offer no impediment to the course of the injec-



tion. But this operation demands necessarily some precautions, without which it cannot succeed; and it is perhaps a want of such care that has caused this method to be abandoned, as it is not at all used, although it is to be met with in certain works upon anatomy.

In placing the body beneath the receiver, and making the vacuum, it is plain, first, that if the blood be coagulated it will not escape, and hence the first condition requisite for success is, that the animal be very recently dead, so that this fluid may not have set; secondly, the vacuum must be made very cautiously, *i.e.*, slowly, so as not to produce a too rapid dilatation of the vessels, and disengagement of gas, which would cause their rupture in several places; thirdly, in restoring the air too rapidly to the receiver, from not being able to get soon enough into the vessels, it compresses the body, and occasions numerous injuries.

Before making the vacuum in the vessels, an endeavour should be made to empty the veins, by pushing air from the arteries by means of a pump.

592. The *lymphatics*, from their close resemblance to the veins in structure, and the numerous valves which intersect them, are also injected by the branches; but as they are very delicate and pale in colour, from the nearly watery conditions of their contained lymph, they are with difficulty perceived at first, until with a little attention they are gradually recognised as greyish, slightly transparent, and nodose tracts, which are rendered more distinct by immersing the specimen some hours in warm water, which is absorbed, and distends them.

The surface of bodies upon which it is wished to inject the lymphatics, by drying rapidly destroys all trace of these vessels, but they may be caused to re-appear by moistening the parts. When they are empty, they are with difficulty detected; and this often happens from the effect of pressure in handling the parts, but by pushing a little of the contained lymph, either with the handle of a scalpel, or simply with the finger, they become raised afresh from the surface, and sufficiently distinct.

593. To be convinced of the communication of the lymphatics with the veins, Fohmann recommends emptying those that traverse the lymphatic glands, upon an animal recently dead, and examining them some time after, when the lymph will be found to have poured out. This experiment is particularly easy upon the mesenteric glands of an animal that has died during the full process of digestion; the chyloferous tubes being then gorged with the product of their absorption, pour it in abundance into the veins empty of blood.

The subjects most fitted for the study of the lymphatic vessels are young, rather lean than fat, and of lymphatic temperament, the skin of such being very moveable from a great quantity of subjacent cellular tissue, and somewhat infiltrated. In these subjects the lymphatics are usually large, and moveable in themselves; but those in whom the principal seat of disease has been in their glands are less suited for this kind of research, these organs being generally engorged, and not allowing the injection to pass.

Many anatomists, and among others Cruikshank,

propose first injecting the blood vessels of the body with wax, and then macerating it some days in water. By this method, he says, the lymphatics are at once distinguished, and the gas which is developed in them renders them more apparent.

594. The best mode of studying the chyloferous tubes of the Mammalia is to kill an individual while digestion is in full activity—in other words, about three hours after a meal. The chyle being then absorbed in very great quantity fills the vessels, which become very apparent from the white and more or less opaque colour of this fluid, especially in the carnivorous tribes.

Milk may be given those species to drink, who will readily take it, an hour or two before killing them; and the chyloferous vessels are found gorged with it, either from the liquid penetrating without alteration, or the chyle separating more readily.

595. It ought to be remarked here, that in opening a body immediately after death the air irritates the chyle vessels to such a degree as to cause them to contract, and the injection thus disappears at the end of some minutes. If, on the other hand, the body is cold, this does not take place, but it should cool rapidly, or otherwise the chyle has time to pour out.

596. According to Mascagni, very beautiful injections of the lymphatics of the serous and mucous membranes may be obtained by filling the cavities which they line with some finely coloured liquid, as they absorb this even after death, and becoming filled exhibit a perfect injection, such as could not be obtained by any other means. The fluid should be water coloured with archel,

or oil of sweet almonds coloured by alkanette, or simply milk.

597. As to the actual dissection of the blood vessels, or the methods of tracing out and unravelling their course, they are performed as for most other organs by the aid of a scalpel and scissars, taking care to keep the membranous or cellular parts well moistened, so as to remain infiltrated, and yield readily to slight traction, without disturbing the vessel itself, which must be left adherent by one of its surfaces to an organ which will support it. In order not to cut the vessels inadvertently, their course is to be first explored with the end of the finger, so as to be distinguished through the parenchyma of organs, and the latter afterwards removed with the scalpel, care being taken never to turn the cutting edge towards the vessel more than is required. When vessels are being traced in membranes or a mass of cellular tissue, it is better to use only the scissars or the point of the scalpel, with which to scrape these parts in following out their direction. In this way the fibres of these membranes or of the cellular tissue are torn, without injuring the vessels.

When, however, a great resistance is met with either from very strong fibres or an accumulation of cellular tissue, it is overcome either by cutting with the scissars or gliding the blade of the scalpel along the vessel, with its back turned somewhat obliquely towards it, or the resisting object is seized with the forceps, drawn aside, and the blade of the scalpel being passed flat along the vessel, the latter is freed.

598. Blood vessels can be also dissected without

previous injection, especially when it is only wished to see the principal trunks. The arteries, whose coats are thick and resisting, are easily traced; but in regard to the veins, being filled with blood, a risk is run of wounding them every instant, and so causing a diffusion of this fluid, which soils every thing to a considerable extent. To prevent this inconvenience, care must be taken to push the blood gradually with the fingers towards the large trunks as one proceeds, and the valves hinder its return.

599. PRESERVATION.—Preparations of the vessels are distinguished, as in other systems, into those of the tissues, and those of the entire organs. The first should be always preserved in fluid. As to the second, which comprehend principally injected specimens, they can be kept dried, which is usually the best plan, especially if they contain no other soft parts than vessels, or when they are simple membranes, sometimes so fine that the most delicate capillaries are perfectly seen. When the layers are somewhat thick, and the small injected vessels are not very well distinguished, a slight transparency can be given them by varnishing, after having washed them over with corrosive sublimate. The thick specimens, on the contrary, supporting other organs, such as muscles, &c., should be preserved in fluid.

#### AVES.

600. DISSECTION. — Preparations of the heart of Birds are made precisely in the same manner as those of the Mammalia, and it need merely be remarked, that

being placed more in advance in the thoracic cavity, the anterior part of the sternum and the coracoid bone must be removed on the side from which it is intended to operate, in order to get at it, which is very difficult, from the great thickness of the pectoral muscles. It is not advisable, therefore, to inject the arteries from the aorta, as, in reaching it, a great part of the body is destroyed, and a considerable number of vessels necessarily cut, all of which it would be impossible to tie, and it had better be injected by the large arterial trunks.

601. The same instruments and methods of injection are used as for the Mammalia. The arterial system is injected either by the common carotids, the femoral or one of the arteries of the wing; but as the first of these vessels offer the most facility from their position, they are to be selected in preference.

602. As regards the *lymphatic vessels*, which differ not only in their structure and arrangement from those of the Mammalia, but are more difficult also to detect, especially in the skin, from the feathers presenting an obstacle in that situation, it may be as well to transcribe the methods indicated by Alex. Lauth:—

“The lymphatic system of Birds being like that of Man and the other Mammalia, more developed in young subjects, these are to be chosen when they have first attained their perfect development.

“The method I employ for rendering the lymphatics visible, has been pointed out by Dr. Fohmann at Heidelberg. It consists in removing the feathers from the upper part of the extremities of the bird immediately after death, and encircling them sufficiently tight with

a ligature, so as to arrest the progress of the lymph, without, however, cutting the flesh. A similar ligature is placed on the lower part of the neck, which being done, the bird is plucked, for the sake of convenience, during the operation. I should remark, that the wing-feathers must be carefully drawn out, so as not to bring away at the same time the portions of skin which surround them. In order not to soil the preparation, it will be besides convenient to singe those birds which are covered, as the Palmipedes for example, with a thick down. Immediately afterwards our researches into the lymphatics are commenced.

“In warm weather the bird must be covered with a wet cloth to stop the drying of the parts, which would render the injection impracticable. Being laid upon its back, a small portion of the dermis which covers the toes and metatarsus is removed, leaving the subjacent cellular tissue. If the bird is old, it is convenient to remove previously the epidermic scales, which, being very thick, impart much rigidity to the skin. The lymphatic vessels, coming from the lateral parts of the toes and natatory membrane (in the Palmipedes), form in this situation a small plexus, into some of the vessels of which it will be easy to introduce the tube, they being recognised at once by their transparency and want of colour. Considering their frequent anastomoses and few valves, it will be sufficient to inject three or four on the anterior part of the foot; the subject is then turned, and as much done upon the posterior surface. In the Palmipedes and Grallæ, the finding of the lymphatics in the foot offers no difficulty; but it is not the same in other

orders of birds, where the lymphatics are so delicate, that they appear like the finest lines. These vessels can most frequently be injected only on the tarsus where they accompany blood vessels, which will guide the anatomist in his researches. This difference of size in the lymphatics of the feet in different orders of birds, appears to me to depend upon the difference of the element in which they live, the Palmipedal and Grallatorial tribes having the lower extremities most frequently immersed in water. An argument in favour of the absorbing power of lymphatics might be deduced from this circumstance, if that doctrine were not already demonstrated by a multitude of more direct facts.

“The lymphatics of the wings follow, still more exactly than those of the foot, the course of the blood vessels, and may therefore be found by investigating the latter. I have usually introduced a tube into a vessel situated in the internal part of the inferior border of the tip of the wing.

“The lymphatics of the neck are so voluminous and easy to see, that the practised eye distinguishes them at once. A rather considerable plexus is in fact found on all the lateral and superior parts of the neck. I would observe in regard to these lymphatics, that I have most frequently found them filled with a reddish or deep red lymph. It appears to me probable, that this colour proceeds from recently absorbed blood, the birds I have injected being killed by division of the carotids. On casting a glance at the lymphatics of the neck, it would seem very easy to inject them, and yet it is not so. A cellular tissue, with very widely separated meshes, unites



them so feebly to neighbouring parts, that they offer no resistance to the introduction of the tube. It is consequently essential to expose the vessel perfectly before making any incision, and this being done, the vessel is held from above by the forceps, after which there is no difficulty in the introduction of the tube.

“For injecting the lacteals, a bird is killed three or four hours after a full meal. These vessels (which, from the want of colour in the chyle, would be better called lymphatics of the intestines) are injected sometimes in a retrograde course from those of the extremities. If this is not done, or it is wished to limit ourselves to their injection only, after an opening has been made in the abdomen, a ligature is put round the mesenteric vessels, as near as possible to their origin. The progress of the chyle is arrested, and the lacteals, which continue to absorb some time after death, are soon found gorged with that fluid. Hewson, who pointed out this method, practised it upon living birds, which is, according to my experience, useless. To prevent the speedy desiccation of the parts contained in the ventral cavity, care must be taken to sprinkle them frequently with water..

“After having filled the lymphatic vessels, different coloured injections are driven into the veins and arteries; and if it is wished to preserve the specimen in spirits of wine, the injection of the lymphatics has only to be resumed to fill anew the vessels which might be empty during the operation, and the vessel is at once tied to prevent the exit of the mercury after injection.”

603. PRESERVATION.—Preparations of the circulatory system, or of its parts in Birds, are preserved like

those of the Mammalia, either in the fluid or in the dry state.

### REPTILIA.

604. DISSECTION. — The preliminary preparations for the dissection of the circulatory system of Reptiles, such as injections, are always the same as for the Mammalia, but the dissection properly so called, by which these organs are disclosed, varies considerably, according to the order to which the subject belongs.

The Saurians resembling much the Mammalia in the general form of their body, will be treated like them in this respect. But it may be remarked, that these animals having usually a very short neck, it would be difficult to inject them from the carotids, these vessels being placed too deeply for the extent of the space. The arteries must be injected by the large trunks, at their extremities, or by the caudal artery, which forming the continuation of the aorta, will permit the injected substance to spread more equally throughout.

605. For the veins, the caudal branches, those of the four extremities, and if possible, the branches of the head may be injected.

This preliminary operation being ended, the body is opened, as in the Mammalia, by removing the sternum and the lower half of the ribs. As concerns the Ophidians, preparations will be made as for the Saurians, only the vessels will have to be injected at the two ends of the body.

As to the Batrachians, the Urodelaë can be injected like the Saurians, and the Anoura by previously raising

the skin, by a longitudinal incision made along the sides and the external surface of the extremities, leaving it simply attached down the back, upon the front of the chest, in the groins and axillæ, where the nutritious vessels pass into it. The animal being thus almost entirely flayed, without any further injury than cutting the integument, which contains but very delicate vessels, some branches of the crural or humeral, arteries will be detected for injection.

606. To disclose the *lymphatic hearts* of *Coluber flavescens* and *natrix*, Panizza recommends raising a certain extent of skin upon the sides of the body, at a point opposite to the anus below. A mass of muscles is perceived, divided principally into three parts, one of which, longitudinal and superficial, is placed above the transverse apophyses of the vertebræ. In separating this mass of muscles, by pulling it from above, two others, also longitudinal, are disclosed beneath it, and in the space between them, the vesicle or lymphatic heart, placed between the two branches of the caudal vein and the first hæmapophyses of the vertebræ.

Preparations of the heart and vessels are preserved like those of the Mammalia and birds.

#### CHELONIA.

607. DISSECTION.—The heart being placed towards the middle of the carapax above the posterior extremity of the coracoid bones, it is impossible to disclose it without opening the carapax widely, and consequently cutting a number of vessels by which the injection would escape

if propelled into the aorta, and the operation fail. It is better, therefore, to inject from the peripheral vessels either the carotid, which is detected along the inferior part of the neck; the cervical placed along the nape of the neck between the superficial muscles; the superior caudal artery running by the side of the spinous processes, or even from the extremities by the external brachial artery in front, which crosses the humerus obliquely outwards, and behind, by the anterior tibial placed in front, between the two bones of the leg.

608. For the veins, different branches, as usual, will be selected upon the neck, limbs, and tail. They may be injected by the jugular, placed along the supra-lateral part of the neck, by the ante-brachial, which passes obliquely from below upwards, on the outer side of the fore-arm; by the peroneal vein, situated along the antero-external surface of the leg, or even by the caudal vein, placed along the supra-lateral part of the tail, above the transverse apophyses.

609. Proceeding then to the actual dissection, the body is opened from below, as has been pointed out before, in the paragraph upon the preparation of the muscles. The vessels which pass to the muscles of the parietes of the thorax, those of the pectoral muscles, and of the shoulder will be first studied. Removing afterwards these organs, as well as the coracoid bones, the heart and its appendages will be found beneath.

The body being once opened, the lymphatics are also to be examined, and especially their reservoirs.

## PISCES.

610. DISSECTION.—To disclose the heart of an ordinary fish, such as a *Cyprinus*, *Perca*, *Esox*, &c., the body is opened below, in the fore part of the abdominal cavity, in the angle formed between the branchiæ. After having raised with the integument the muscular mass, which forms the lower part of this angular projection of the belly, the thoracic cavity is found at a little depth, enclosing the pericardium, the arrangement and adherence of which to the rudimentary diaphragm is noted, so that it may be taken out afterwards with this latter. The ventricle is opened from below, so as not to injure the surrounding parts of the auriculo-ventricular opening placed obliquely in front and above. The auricle and bulb of the branchial artery should also be opened below.

Injections may be made by the aorta, and for this purpose the abdominal cavity is opened along the median line, and the viscera separated, when the above vessel and posterior vena cava are found along the vertebral column, but they must be injected in two different directions. The branchial vessels can also be injected from.



## SECT. II.—ARTICULATA.—ANNELIDA.

611. DISSECTION.—In opening the body of a red-blooded Annelidan, the vessels are perfectly well seen, and very prettily displayed by their colour upon the white ground of other organs. But this beautiful sight

soon disappears, by the blood pouring out in a few minutes from the numerous vessels that have necessarily been opened. The parietes of these vessels are besides so feeble that it is extremely difficult to inject them, it being very troublesome to introduce the pipe of the injecting apparatus, and especially to fix it. It is advisable for injecting these vessels, to open the body towards its posterior part, either along the back for the superior vessel, or along the belly for the inferior; excepting in large species, preparations made of these organs can seldom be preserved.

#### CRUSTACEA.

612. DISSECTION.—The heart being placed immediately beneath the shell of the dorsal part of the body, to which the auricle adheres throughout the whole length, great precaution must be taken in opening the subject not to injure the ventricle. For this purpose, a small layer of integument is removed by a very oblique cut with the slice, along the middle of the back, by cutting from before backwards. By acting in this direction the segments are stretched one from the other, and nothing is displaced or huddled together, whilst in cutting from behind forwards, the segment operated upon returns into the one preceding it, relaxes, shakes, and destroys by its movements, the auricle placed beneath. The latter being thus opened within a very narrow space, is probed to see how and in what direction the aperture may be enlarged without cutting its attachments. After having well examined its general dispo-

sition and extent, its lateral attachments are cut to see the arteries passing from it, and the dissection then pursued according to the end proposed.

613. When the parts are too small to admit of the back of the animal being thus opened without injury to the heart, the latter may be more readily reached by opening the animal from below, but to effect this, it is very evident that the other organs must be removed, which should hardly be done until they have been dissected; and it is besides seldom then that the heart is in a sufficiently good state to be studied, on account of the numerous movements which the different portions of integument adjoining it have experienced, so that it is as well to determine upon seeing the heart only, and to sacrifice all the rest. In this last case a horizontal cut is made from before backwards, through all that part of the body where this organ is, and sufficiently deep, so that the cutting instrument passes for a certain distance beneath the auricle without injuring it.

614. Another method which M. Straus-Durckheim most frequently employs is, slitting the body longitudinally in a vertical direction, at a sufficient distance from the median line so as not to reach the auricle, and this is afterwards opened from the side.

In some very small Crustacea, which have the body transparent enough to enable the internal organs to be distinguished, the heart is often seen to beat isochronously, and with great rapidity. For counting the number of pulsations in a given time, the method already indicated for counting the rapid pulsations of the branchiæ is used (§ 553).

The best way of injecting the arteries, is to place the pipe in the posterior artery if there is one, or even into the posterior extremity of the ventricle itself which is easily exposed, or even into the branchial vessels. These organs being very often free upon the side, or at least easily exposed, the principal pedicle of one of them has merely to be cut transversely, to find at once the two branchial vessels, in which the pipe is conveniently fixed. By placing it in the branchial arteries, the venous system is injected.

615. Another method has been pointed out which succeeds very well in large living species, and which consists in simply placing the pipe in the branchial veins, and injecting the fluid by very slight pressure, for which nothing is better fitted than the small injectory (¶ 33). The substance injected runs slowly and without effort in the ventricle, which propels it of itself into the arteries like blood, and there it fixes. It is probably useless to remark here, that the injecting mass should be neither warm nor irritating, so as to occasion any disturbance in the circulation. The best kinds will be gelatine, white of egg, and milk.

Preparations of the vessels of the Crustacea can be only preserved in fluid.

#### ARACHNIDA.

616. The arteries of large subjects may be very well injected, but even without this preparation, they may be followed out to their smallest ramifications. By adopting this more troublesome method, no risk at least is



run of spoiling the preparation by a failure in the injection, as very often happens in individuals kept a long time in fluid. M. Straus-Durckheim has in this manner traced out the arteries of *Mygale Blondii* to ramifications finer than hairs.

Preparations are preserved in fluid.

### MYRIAPODA.

617. For preparing the heart of the articulated animals with tracheæ, the body must be opened from the ventral surface, all the viscera removed successively, and the ventricle left with its ligaments in place, attached to the upper rings of the body. The superior segments of the abdomen can also be removed in an entire piece, by cutting with scissars along the lateral membranous bands, and removing together all the upper part of the abdomen; but care must be taken to cut with the microtome all the branches of tracheæ which pass upon the heart or its alæ, as the strain exercised by these vessels upon them would, if not rupture, undoubtedly displace them. In afterwards fixing the anatomical specimen upon a piece of cork, or in endeavouring to open the heart, care must be also taken not to draw it out lengthways, which would produce extension of this organ, and cause not only its inflected folds, but the auriculo-ventricular valves to disappear. This vessel being very narrow is very difficult to open. To proceed, however, with more chance of success, the specimen must be first fixed on a plate of cork, placing pins enough to prevent movement in any part: the heart is found attached to

the superior arcs of the abdomen by its lateral ligaments.

Making then with the microtome a small notch in the ventricle in its inferior median line, one of the points of that instrument is very obliquely introduced from behind forwards in the direction of its valves, so as to slit up this organ by degrees throughout its whole length. Separating gently the two lips of the slit the arrangement of the valves is already perceived, and by cutting the lateral parts these valves can be freed so as to see them from each of their surfaces. If, on the contrary, it is wished to see them from the side, the longitudinal slit just spoken of is made, and then a second incision carried opposite to it along the superior median line. As a guide in doing this, the first slit may be held slightly open by catching its edges with very small hooks with weights attached (§ 63).

The heart once slit throughout its whole length is cut on a level with the lateral ligaments, so as to place each half upon its side. All these operations upon a body so small and delicate demand much care, and especially great steadiness of hand. Upon large *Scolopendræ*, such as *Scolopendra Morsitans*, injections might however be tried with some success, their heart being a vessel of sufficiently large size (nearly  $\frac{1}{25}$ th of an inch in diameter in the largest species of *Scolopendra*), and by this means better than by direct dissection, and without any preparation, it could be determined how the three arteries terminate in the head. These researches are to be recommended to persons living in warm climates, who have these animals fresh at their disposal; those

made here being necessarily performed upon individuals preserved in alcohol, and scarcely fitted to serve for injections.

These preparations cannot be preserved, being too small.

#### INSECTA.

618. The heart of Insects is prepared like that of the Myriapoda, and like theirs also cannot be preserved.



#### SECT. III.—MOLLUSCA.—CEPHALOPODA.

619. DISSECTION.—To expose the three hearts of the *Octopus*, *Loligo*, &c., the body must be opened as for most of the other organs along the median ventral line. The sac is first slit, and the abdominal cavity next opened between the bases of the two branchiæ and from above, where the two venous hearts are placed, with the aortic in the middle, but a little higher. The aorta being placed towards the dorsal region is found disguised by the viscera, which must be removed to see its principal branches.

The common vena cava and its branches are seen by opening the visceral cavity.

After having opened the body in the neighbourhood of the hearts, they may be readily injected. The injection of the two systems of vessels can be done either from the arteries or the veins of the feet, which are easily discovered by cutting one of these members transversely. The injection can be also performed by

the branchial vessels, after having opened the sac along the ventral surface.

The preparations are preserved in fluid, which ought not to be too astringent.

#### GASTEROPODA.

620. DISSECTION.—To prepare the heart and principal blood vessels of the Gasteropoda, it is evident that, from their position not being the same throughout the whole class, the point at which they are to be disclosed must be previously known in each genus to be examined. In *Limax*, a crucial incision is first made in the middle of the adherent part of the mantle; by this the capsule of the shell is opened, the roof of which forms in its circumference the floor of the pulmonary cavity, and in its middle, and a little to the left, the gland of the viscosity and its excretory canal, which are readily distinguished by their yellow colour; in front of this organ is found the pericardium under the form of a white vesicle.

When it is wished to inject the arteries this sac is cautiously opened, and a small incision made in the auricle, to introduce the jet of the blowpipe, which is sufficient here, and which is pushed to the middle of the ventricle, so that a ligature may be placed between the two parts of the heart, and the matter driven in.

To inject the aorta separately, the body is opened in the posterior third of the dorsal region, by making also a crucial incision, by which the abdominal cavity is opened, where the stomach is found on the right, and

on the left side the ovary and the liver. By separating the first of these last two organs, the posterior aorta is seen at the bottom.

621. The veins are more difficult to inject, although of much larger diameter. The principal trunks of the venæ cavæ being placed in the lateral parietes of the body are so compressed in contracted specimens, that the injection penetrates their branches with difficulty. Subjects must be therefore selected which are well extended, and left to macerate twenty-four hours in water to soften them; yet even then it rarely or in part only succeeds. If a very penetrating mass is employed, such as coloured alcohol, it passes very often into the tissues, and nothing can be distinguished. M. Straus-Durckheim employs ordinarily for these injections gelatine, or the fatty mass (§ 97), which penetrates very well into the small vessels but not into the tissue, and does not at all soil the preparations.

For injecting the venæ cavæ of *Limax*, a small slip of the lateral parietes of the body is removed with a sharp *slice* at a nearly equal distance from the border of the foot and the median dorsal line, taking care not to penetrate the visceral cavity. The vena cava is opened by this cut, and is in *Limax rufus* more than  $\frac{1}{25}$ th inch wide.

622. The heart of *Helix* being placed in the left posterior part of the shell, above the origin of the tail, and by the side of the gland of the viscosity, is easily disclosed from the colour of the latter, as in *Limax*. The herniary sac is first cut, and then the pericardium placed beneath; and in order to handle the subject more easily,

the shell is only removed at the spot where the heart is found.

623. To see the heart of *Doris*, a transverse incision must be made in front of the circle of the branchiæ, and a longitudinal one afterwards along the middle of the back, in proceeding from which, and turning back the two slips, the heart is found beneath in its pericardium, as well as the aorta, which passes forwards, and is perceived penetrating between the lobes of the liver. In isolating the auricle from the fleshy parts covering it, the trunks of the branchial veins, which come to it from the branchiæ, are readily distinguished.

624. In the *Halyotis*, the shell must be first detached from the body. For this purpose the animal is lifted up by holding the shell horizontally, and the blade of a scalpel being introduced quite flat between this and the mantle, the large muscle by which the body is fixed is cut through. Behind, and to the left of this muscle, is the pericardium, which is to be opened. The branchial cavity, placed to the left of this muscle, may be also opened at first, and the rectum traced from before backwards, leading to the heart, which it traverses.

In the same way as for all other preparations to be made upon the spiral shelled Gasteropods, uncontracted individuals must be used if possible. The air-breathing species are obtained well extended by the means indicated in speaking of the preparation of their muscles. The others contract but little, with the exception of the Pectinibrachiata, which it is almost impossible to get entirely extended.

## ACEPHALA.

625. DISSECTION.—The heart of the Ostracodermous Acephala is easily discovered, as it occupies regularly the dorsal region of the body, between the back and mantle, where the pericardium is easily remarked as a large apparently empty vesicle, which being usually wider than is necessary for containing the heart, may be easily cut into, and the latter exposed. Among the *Anodons* and *Cardiaci* it is found readily in the middle of the back. In *Mytilus*, it is situated in front of the dorsal cavity, between the mass of the liver and the ovaries, and between the insertions into the valves of the first retractor muscles of the body. In *Lima*, it is seen above the posterior closing muscle. As to injections, they may be made either from the artery which runs over the border of the mantle, or from the ventricle, where it is nevertheless difficult to reach it without destroying anything, on account of the proximity of the valve in which the body remains fixed, and a part of which must be broken.



## SECT. III.—RADIATA.—ECHINODERMATA.

626. DISSECTION.—The two vascular systems of the Echinoderms may be injected, although the parietes of the vessels are usually very feeble. To see this system in *Holothuria* the body should be opened along the inferior median line, and the three folds of the intes-

tinal canal separated by removing them to the right. The first two folds of this last being bound down in the middle of the body by a very large anastomotic branch of the aorta, this loop is to be cut through in the middle, and used for injecting the arteries from. For the principal veins, a pipe is placed in one of the large venous trunks, placed towards the posterior part of the body, between the first two folds of intestine and the right cælobranchia, and the injection passing with difficulty in the cælobranchial arteries, it is convenient to inject their trunk separately. This is situated, as has been seen, between the right cælobranchia and the second fold of intestine running along the latter. It may be more easily injected by its anterior extremity, where the intestine is folded a second time.

The vessels of the second system, may be injected by the large vesicle placed on the side of the stomach, and from which the liquid flows with facility into the small feet. The liquid naturally contained in these organs may be made to pass alternately, to and fro, from the vesicle into the feet, and *vice versâ*.

627. To inject the *Echinus*, the body is opened as usual, by sawing the shell horizontally into two halves, taking care not to injure the alimentary canal. The heart will be easily found at the side of the œsophagus, but as it is impossible to separate the two halves of the shell, without rupturing either the aortic artery or branchial vein, both being very delicate, the one which is not torn may be as well injected from the heart, and the artery, if crushed, would be better injected by taking it nearly in the middle of the length of the alimentary



canal, where it is larger than towards its extremities. The vena cava and the branchial arteries, placed in the mesentery, should be likewise injected in the middle of the length of the intestinal canal.

As to the vascular system appended to the feet it is injected by the five longitudinal trunks, opened by the section of the shell, and which are found in the middle of the double series of small feet.

628. The first vascular system of *Asterias*, or the intestinal system, may be injected from the heart. For this purpose a longitudinal incision through the integument is made in the middle part of the body, from the plate visible externally corresponding to the exit of the sand canal, which is situated in the same falciform ligament as the heart. This incision should be directed from this plate downwards, towards the retreating angle of two corresponding rays, and be crossed by a second towards the middle; so that the four flaps may be turned back. In this preliminary operation care must be taken not to wound the heart, and to open skilfully the falciform ligament to expose it. After having examined and become acquainted with the form and structure of this organ, it should be cut across transversely, and the two ends injected; the venous system by the upper, the arterial by the lower. This injection being done, the entire body is opened, as for seeing the intestinal canal, and the ten branches of the circular vein traced along the mesocœcum.

As to the arteries they may be prepared in the same way, proceeding from above downwards, so as to reach at length the circular vessel made by the aorta round

the œsophagus, and to trace its branches, which pass along the under surface of the cœcum.

The vessels of the vascular system, appended to the feet should be injected, according to M. Tiedemann, by opening the body from above; the whole digestive apparatus being removed by cutting the œsophagus as near as possible to the stomach, by which means the circular canal, which surrounds the mouth is disclosed, as well as the five packets of vesicles, the pedicles of which open into this canal. In injecting by one of these pedicles this whole system of vessels is easily filled. M. Tiedemann injected these vessels also very well from the small feet, without opening the body.

629. To see the sand canal, the body is opened from above, as is pointed out in speaking of the digestive apparatus, and after having removed the stomach, the canal will be seen in the form of a large tortuous vessel descending along the falciform ligament which corresponds to the external plate.

#### ACALEPHA.

630. The vessels of the *Acalephæ* can be scarcely studied, but by injecting them from the mouth, and that by means of a gelatinous mass, which fixing slowly has time to penetrate into all the ramifications of the chyloferous vessels.

These preparations should be preserved in a fluid which does not too much contract the parts.

---

## CHAPTER XIII.

---

 NERVOUS SYSTEM.
 

---

SECT. I.—*VERTEBRATA*.—MAMMALIA.

631. DISSECTION.—The whole central portion of the cerebro-spinal system could hardly be prepared upon a single subject, as it would be too large and delicate not to be injured by the numerous movements, as well as force, required to be used for dividing the bones, which so closely encase the brain and spinal cord, and it had better therefore be prepared separately, by detaching the former between the cranium and the atlas, and the latter lower down, betwixt the cervical vertebræ, when it is wished simply to study the central organs of the nervous system alone. If, on the contrary, a preserved preparation for a collection is the object proposed, and it is wished with that view to have the whole together, not only then is no attempt made to study the parts, which should be already known, but the time necessary for making such a preparation, and full means and appliances must be quite at our disposal.

632. To prepare the *brain* and its appendages upon the same subject, which is a very difficult task, the head is to be separated, as has been said, between the second and third cervical vertebræ; and being placed with the face downwards upon a prop, and kept there by hooks and

weights, arranged in different directions, the upper part of the cranium is denuded of its coverings to a level in front with the orbits, and behind with the occipital protuberance, and two longitudinal incisions each in the human subject, about half an inch from the median line, made in it with a saw and prolonged on the one hand to  $\frac{3}{8}$ ths of an inch from the orbit, and on the other to just above the occipital protuberance. These lines with the saw should be very cautiously made, and in several parts, so that the instrument may not penetrate into the cavity of the skull, and lacerate the membranes of the brain; and it is best to leave at certain intervals, or throughout their entire length, places not completely cut through, the separation of which may be completed either by means of the bone nippers (§ 70), or the lever and chisel (§ 66, 67).

633. Before finishing the separation of the bones, a horizontal cut is made very carefully to pass by the extremities of the first. In this way a large lateral piece, formed partly by the frontal, squamous, parietal, and occipital bones, is circumscribed, and removed by breaking it into small bits with the bone-nippers or lever. As the cranium is penetrated by degrees the dura mater is detached from the edges, and small slits made here and there in that membrane to allow the admission of air into the cavity, so that in removing the lateral piece, when separated by tearing it, the substance of the brain may not be dragged along with it; or the dura mater can be slit up all along the line of section, before removing the piece.

The above method is nearly that ordinarily employed,

but it is long and difficult; and it is much more convenient to remove the lateral pieces in small fragments. For this purpose a small opening is made simply in the supra-lateral part of the cranium, with a trephine or some other instrument, and sufficiently large to introduce the blades of the bone-nippers, and with this implement alone pieces are cut out of the cranium all around it, until the aperture is of the required size and form; for the lateral piece thus destroyed is of no use afterwards.

634. After having removed the side portions, the falx will be seen *in situ* along the osseous strip which has been left, and these large openings admit also of the remaining lateral parts of the parietal and occipital bones being cut upon a level with the lateral groove to which the tentorium is attached, and which will be easily seen by lifting up the posterior lobes of the cerebrum.

The bony attachment of the falx is to be then removed, after detaching the latter, either by tearing away its adhesions, or cutting it with a scalpel upon a level with the bone. The lateral and anterior attachments of the tentorium are also to be cut.

635. Before turning out the brain from its case the arachnoid membrane should be examined upon its upper surface, to see how it passes freely over the convolutions as a very thin web, without dipping between them. It may be detached by making a very small incision, and blowing air between it and the pia mater placed beneath. Before disturbing the brain by separating its posterior lobes, the orifice of the arachnoid canal placed beneath

the posterior geniculation of the corpus callosum will be seen.

To raise the brain from the lower half of the cavity on which it rests, the lateral parts of the cranium are first removed by the bone-nippers, upon a level with the petrous bone, and the falx cut at its anterior extremity where it is attached to the crista galli. The skull is then inclined sideways, the brain being supported, so that by its own weight it is detached from the base of the cranium. The tentorium is cut along its lateral attachments, and the head turned still more sideways, to disclose the origins of the different nerves which are cut through at the point where they traverse the dura mater, so that ends of sufficient length remain attached to the brain. This viscus being entirely detached is removed by turning it out upside down upon a folded napkin.

636. If the brain is soft, it had better be placed for some days in a fluid which hardens its substance, such as nitric acid diluted with water, alcohol, or an aqueous solution of alum.

637. The upper part of the brain having been examined before it was turned out of the cranium, there remain only the inferior parts to be seen.

The longitudinal and transverse sinuses of the dura mater having been examined before the removal of the brain, those placed upon its under surface, such as the lower part of the lateral sinuses, the inferior and superior petrosal have yet to be studied, and different strips of dura mater to be detached, to examine their texture.

638. If it is wished to make a special preparation of

the dura mater, either for simple study or for preservation, it may be commenced, according to the method indicated by M. Lauth, by clearing the head externally of every part which is not to be preserved. A crucial incision likewise is made upon the vertex, so as to turn back the four strips of integument, as in the preceding preparation. A single longitudinal cut is then made in the cranium with a saw, about half an inch from the median line, and carried from the frontal eminence of one side to  $\frac{3}{4}$ ths of an inch above the occipital prominence, exactly as before mentioned; but as the brain itself is not to be kept, the bones are slit quite through. A second horizontal cut upon the same side, and perpendicular to the first, should cross the extremities of the latter, and the upper border of the squamous bone. Having thus removed an entire segment of the cranium there will be a large opening, by which at first mechanically, and then by washing in plenty of water, the whole cerebral and cerebellar substance may be removed, leaving all the parts of the dura mater *in situ* and quite complete upon the unopened side of the cranium; and thus the different folds of this fibrous membrane, as well as the sinuses which it forms, can be readily traced and studied.

639. If the preparation is wished to be preserved, water of about 120 degrees of temperature must be first of all injected with moderate force into the different vessels that are found open, to drive out the blood they contain, if they have not been injected beforehand with some solid substance. The specimen is then placed for some days in a bath of the same temperature, which is

allowed to cool in summer, but which must be kept in a warm place in the winter, so as to clear all the small vessels of the blood still within them. The specimen is then taken out and dried in the air, and when well dried is moistened slightly all over, by pouring upon it a little acoholic solution of corrosive sublimate to preserve it from insects, and dried again for the last time.

If it is not intended to have the *dura mater* complete upon one side, a segment of the cranium may be removed from both.

640. The *arachnoid* may be studied on the upper surface of the brain. After the corresponding bones of the cranium have been removed, it is detached in the intervals of the circumvolutions, where it is separated from the subjacent *pia mater* by blowing air through a blow pipe between them, and then removing strips for examination of their structure under the microscope. This membrane is particularly easy to distinguish around the pituitary gland, where it is free. It can also be detached, but with more trouble, by maceration from the part where it is reflected upon the *dura matter*, or sometimes may be mechanically separated without any previous preparation.

As to the *pia mater* it can be easily removed from off the brain, to examine it in particular, and see how it is inflected between the convolutions.

641. The *choroid plexuses* ought to be traced from the exterior into the interior of the ventricles by the orifices of the latter, and first through the middle ventricle placed beneath the posterior geniculation of the corpus callosum, where its prolongation takes the name



of velum interpositum. Another penetrates into the fourth ventricle by its sinus. These plexuses should be examined also in opening the ventricles.

642. To see the under surface of the brain, it may be simply turned over upon a cushion formed of a folded cloth, and better still, by placing it in the upper part of the cranium, if it has been preserved. The arachnoid and pia mater are first removed in strips that they may not bind down the parts to be displaced, but attention must be paid to cut the last of these membranes carefully, in situations where it dips into the ventricles, so as not to disturb the choroid plexuses. Care should also be taken not to use force in stripping off the layers which adhere to the nervous trunks, for fear of tearing the latter, which happens easily with the more delicate of them. This preparation being made, each part of the encephalon is examined by lifting up and displacing the adjoining parts only as much as is necessary for distinguishing them externally. The brain being studied thus in its superficies, is replaced upon its base, and the actual dissection proceeded with.

643. The *lateral ventricles*, as being higher than the others, are first to be opened, and for this purpose the upper part of the hemisphere is removed by the *slice* in horizontal layers, thin at first, of from  $\frac{1}{4}$ th to  $\frac{3}{8}$ ths of an inch in thickness, so as to see how the grey substance is contorted around and into the convolutions of the white, and to what degree of depth.

In approaching the level of the corpus callosum, care must be taken not to open inadvertently the lateral ventricles, the roof of which is slightly elevated above

the level of that layer, by giving a convex direction upwards to the last and always cautiously made cut, slicing the cerebral substance off from within outwards. This being done, a slight incision is made in the middle of their surface, nearer however to the median plane, so that by separating the edges of the former, these ventricles may be penetrated from above; when once open, the layers of the hemispheres are removed continuously, but in their external parts only, so as to leave uninjured the corpus callosum. In making these successive incisions, and especially the last, an attempt should be made to recognize the fibrous structure of the brain, and the arrangement of these fibres, which pass from the corpus callosum into the hemispheres.

By continuing to remove these layers, the lateral ventricles are more and more opened upon the sides, which admits of our perceiving the disposition of their cornua, and the cerebral masses which project into these cavities. The choroid plexuses, and communication with the middle ventricle, placed beneath the arch of the corpora geniculata, are seen.

Raising next the corpus callosum from the sides, and drawing gently up the middle portion which remains, the small vertical nervous partition separating the arch, the septum lucidum, is very well distinguished. By cutting this horizontally, the third ventricle is opened, the cavity of which conducts to the fourth.

In thus removing the brain, by more or less deep layers, the relations of the grey and white substances composing it are observed throughout.

644. The brain having been reversed, the origins of

the nerves, which all quit it from below, are to be studied, by trying to follow out their roots through the substance of this organ to the parts whence they arise.

645. As to the methods for preparing the *spinal marrow*, nothing particular need be said, care only being taken in opening the vertebral canal, not to injure the membranes, and for this purpose it is convenient to cut the laminae of the vertebræ, with the osteotome or bone-nippers.

To see the fibrous structure of the spinal cord, its upper part has only, according to M. Burdach, to be drawn aside, and its fibres are distinctly shown, especially by soaking them some time in alcohol. Swammerdam had remarked its fibrous structure, and steeped it, merely, some time in warm, and afterwards in cold water.

646. The parts of the nervous system which offer the most difficulties for preparation, are the nerves and ganglions of the head, which have often to be traced within the bones. It is even impossible to make a good preparation of these organs without knowing their arrangement beforehand, as the least inadvertency, or the feeblest effort, when too hurried, for breaking the bones is sufficient to tear these delicate nervous threads that are required to be preserved, and this readily happens, from the shocks produced, in cutting the bones to disengage them.

But these inconveniences may be partly avoided by macerating the entire head in a bath of dilute nitric acid, which has the property of softening the bones, by dissolving their calcareous parts, and imparting more consistence, on the contrary, to the nervous substance.

After the head has remained some days in this menstruum, the bones, reduced to the cartilaginous state, can be cut with the greatest facility.

When the anatomical specimen is very voluminous, as in Man, this preparation becomes difficult, and the maceration must last a longer time. This method can, besides, be hardly employed when it is wished to make a rapid study of the cephalic nerves, but only when it is intended to investigate their arrangement carefully, and without being pressed for time.

647. The nerves of the body, being generally placed between the soft parts, are simply traced with the scalpel and scissars.

The *sympathetic system* is very difficult to prepare in its cephalic portion, where its ganglions, generally very small, are placed deeply between the numerous organs of that part of the body. They are to be studied at the same time as the neighbouring cephalic nerves, and by the same methods. In the cervical regions the work is not so troublesome. The posterior muscles of the neck are first removed, as the scaleni, sterno and cleidomastoidei, which are cut through at their sternal attachment, to be turned upwards.

The jaw is removed with the temporal and masseter muscles, without disarranging those attached either to the tongue, hyoid, or pharynx. The cephalic cornua of the os hyoides are next cut close to the head, so as to turn them forwards and disclose the pharynx. In this manner the deep layer of the muscles of the neck is speedily reached, between which the three cervical ganglions of the sympathetic will be readily discovered.

The preparation of the sympathetic nerve is far easier in the thorax as regards its principal ganglia. There the clavicle, sternum, and half the ribs, with all the muscles attached, have only to be removed, and the lung turned over to the opposite side, and kept in that position by hooks, to expose the whole series of thoracic ganglia, but these, though already visible, are still covered by the pleura, which must be raised with care.

After having examined the branches given off upon the lungs and heart, the latter are removed so as not to be in the way, without however disarranging the aorta and œsophagus, and so injuring the numerous plexuses and nerves there met with.

For the abdominal portion, the diaphragm in like manner is to be cut across at a point equal to about half the length of the ribs, and the abdominal parietes to the crest of the ilium. The liver is removed piecemeal, leaving in its place the part only adjoining the transverse fissure where all the vessels and nerves are situated.

As to the pelvic portion of the sympathetic, it is necessary to remove the posterior extremity with the bones of the pelvis upon one side, the sacrum being left carefully in its place.

648. For the other Mammalia, as presenting but unessential differences in their nervous system, compared with that of Man, the same methods will be pursued, only if the subject is small, it is advisable to place it first for five or six days in a saturated solution of alum, to soften the bones and harden the nerves.

649. PRESERVATION.—Preparations of the cerebral and nervous substances can be preserved only in a liquid which hardens their contexture, and the best for this is alcohol.

#### AVES.

650. The methods for preparing and preserving the nervous system of Birds are exactly the same as for the Mammalia.

As the bones of the cranium are very thin, and filled with a large-celled diploë, they admit of being easily cut with a knife, so that the brain is readily uncovered and turned out of its containing case. The inferior bones have not sufficient consistence to prove troublesome in dissection, and the less so from the head of birds being generally small.

It is advisable also to macerate them for twenty-four hours in dilute nitric acid, or, if there is time for it, for eight or fifteen days in a saturated aqueous solution of alum.

#### REPTILIA.

651. Preparations of the nervous system of Reptiles are made as for the Mammalia.

#### CHELONIA.

652. The brain, like that of Reptiles, is prepared by opening the cranium from above, and for the spinal marrow, the vertebral canal from its dorsal surface; but for the nerves of the body, which are nearly all enclosed in the carapax, this should be opened first sideways to

see the origins of the nerves as well as the sympathetic, and the subject proceeded with as pointed out in speaking of the preparation of the muscles.

The preparations are preserved like all the soft parts of these animals, *i. e.* in fluid.

#### PISCES.

653. To prepare the encephalon of Fishes, the skull is opened from above, which is very easy, especially in those whose bones are not hard, as in the Chondropterygians, where the cartilaginous bones may be easily cut with a scalpel.

The nerves can be most easily prepared from the side, particularly in very flat bodied species, and with a little attention and by dissecting the subject under water, which prevents the *debris* of the organs from sticking together, their direction, which is most frequently different from that of the muscular fibres with which they might be confounded, is well enough recognised.

The internal nerves, as the sympathetic, should be prepared upon a subject, all the ribs of which have been removed upon one side.



#### SECT. II.—ARTICULATA.—ANNELIDA.

654. DISSECTION.—To prepare the nervous system of the Annelides, the body must be opened along the dorsal line, care being taken not to push the instrument too far into the head, where the brain situated above the

commencement of the œsophagus may be easily injured ; the nerves given off from it require to be cautiously dissected, being placed very near the integument. As to the series of ganglia of the ventral cord, they will be disclosed without difficulty, as soon as the intestinal canal has been removed, which is cut in front at a small distance behind the brain.

The inferior ganglia, and the nerves which they produce, are applied against the ventral integuments, and are very easily distinguished.

After having cut all the nervous trunks of the brain, as far as possible from the latter, and the œsophagus at its most anterior extremity, the surrounding organs are detached *en masse*, and being turned back, the nerves given off from the inferior ganglia are in like manner successively cut, so that the whole central part of the cephalo-rachidian system is reached by degrees, and thus removed in a single piece, which is then brought under a lens, placing it in water upon a blackened piece of cork ; the different parts are moved about a little, so as to detach them from each other, and should be replaced quite in their natural position. The fragments of organs which adhere to the brain and ventral cord are then removed bit by bit, and the end of the œsophagus the last, so that it may be seen how the nervous collar embraces it. The preparation being made, the form and arrangement of the ganglia, as well as the origin of the nerves, is to be well examined.

As to the preservation of the anatomical specimen, it is very difficult from the nervous matter coagulating, contracting, and becoming distorted in the liquid.



## MYRIAPODA.

655. DISSECTION.—The preparation of the nervous system of Myriapods is proceeded with nearly in the same way as for that of the Annelida. The body is opened from the back by the same methods as regards the Chilopoda, the integuments of which are flexible enough to be easily folded back upon the sides and then removed. In the head only, where a little more difficulty is experienced, a little of the border of the epicranial piece, as well as its accessory segment may be cut circularly, so as to detach the superior plate all in one piece; but it is better to open the head from above by making a small opening with the *slice*, detaching the piece, and afterwards enlarging this opening by cutting the epicranium into fragments, and not turning back the two halves, which could not be done without the risk of rupturing every thing within the head. In removing the upper plate of the cranium, care must be taken not to detach the part which supports the eyes, nor that upon which the antennæ are implanted, but to leave these organs in their place. The body once opened, is proceeded with as for the Annelides.

The body of the Myriapods being very flexible between the segments, especially when the superior arcs are removed, care should be taken to cause the least possible inflexions of them, as by these the ventral cords would be broken. To avoid this inconvenience M. Straus-Durckheim fixes the body of the animal, before opening it, upon a long and narrow strip of cork, attaching it with pins implanted in the lateral portions of the body,

and then only proceeds to open it, as it can thus be more easily handled than if it were fixed upon a wide piece of cork.

656. For the Chilognatha, the teguments of which are very hard and where there are no lateral membranous bands, which allow the dorsal part to be turned back upon the sides, the proceedings are quite different. The body here should be likewise fixed upon a narrow piece of cork, but as it cannot be transpierced with pins, braces (§ 62) are fixed very closely to the sides of the body, with their hooks resting upon it, so that it is seized as between the branches of pincers. A pair of hooks is thus planted upon every two segments. At the posterior extremity of the body, one segment after another is then cut upon each side, by means of a small osteotome or with scissars, while at the same time the part operated upon is supported by the fingers of the left hand, and by degrees, as a segment is cut, its upper portion is entirely removed, so as not to be in the way; and this being continued as far as the head, the actual dissection is proceeded with afterwards as for the Chilopoda. The preparations of the nervous system can scarcely be preserved.

#### INSECTA.

657. DISSECTION.—To prepare the brain of Insects the head should be opened from above, as for the Myriapoda. To this effect a small opening is made in the middle of the cranium, by simply removing a small circular piece of integument by cutting from before back-

wards, and sawing as little as possible, so as not to turn back the fibres of muscles, which pass for the most part obliquely downwards and forwards, either upon the pharynx or the motor muscles of the mandibles. The cranium being once opened, it can be seen better what is the arrangement of parts which were covered by the scale removed, and how to direct the incisions; the hole is enlarged little by little, until the entire epicranium has been removed, beneath which is readily found towards the middle the brain, between the two adductor muscles of the mandibles, giving off its two large optic nerves to the compound eyes; freeing it by degrees of the circumjacent parts, it is entirely exposed as well as the ganglions of the sympathetic nerve, and the nerves proceeding from both.

As to the inferior ganglia, it is difficult to prepare them in a single piece with the brain, the latter covering the first pair, and each of them should ordinarily be prepared apart. After having well seen the brain, it is extracted by cutting carefully through the nervous collar of the œsophagus at the exit of that viscus, and removing afterwards the pharynx and œsophagus in strips, the first pair of sub-œsophageal ganglia is thus disclosed. To see this well, the cranium must be pared away considerably upon the sides, and its supra-anterior part removed entirely to the base of the mandibles, taking care previously to fix these last as well as the maxillæ, so that they may not move about during the operation; for it is plain that if they are displaced in different directions by moving in their articulations, their muscles being pulled about, would destroy every

thing in the interior of the head. They are fixed, not by transpiercing them with pins, which would be better if the parts were not too hard, but by implanting on the sides small pins, which prevent them from opening.

After having traced the mandibular nerves to their entrance into these organs, they are cut at a short distance from the ganglia, so as to preserve their origin from the latter. The muscles of the mandibles are cautiously removed in small fragments, so as not to disarrange the maxillary, labial and lingual nerves placed beneath. Lastly, the mandibles themselves are detached to dissect the deeper layers of the head, where the parts are gradually removed, taking care not to cut the muscles against their fibres.

658. The other ganglia of the ventral cord should be prepared by opening the body from above, but as they are placed against the ventral surface the whole superior half of the body may be removed at a single stroke.

To this effect a small band of integument is cut from all around the corselet, thorax and abdomen, either with common scissars or the slice, whichever is most convenient, and the subject being fixed afterwards upon a piece of cork with the belly downwards, the upper parts are removed with facility.

In these preparations care must be taken not to cause too great a movement in the different joints of the body, as by lengthening and shortening the body alternately the internal organs would be torn.

659. If it is wished to preserve the brain and all the ganglia of the head with the origins of the nerves as a

single specimen, so as to see better their conjoined arrangement, the head must be first disarticulated, by making a section as near as possible to the corselet to preserve the origins of the nervous cords between the first two pairs of ganglia. A small strip of the cranium is then cut with the slice all round the mandibles. This opening being made, the tendons of the adductor muscles of the latter, which are known to be upon their internal border, are cut from their insertion with the scalpel, or better still with the microtome. Turning back afterwards the mandibles a little outwards, all the parts which unite them to the cranium, such as the integument, tracheæ, nerves, &c., and lastly, the abductor muscle placed quite on the external edge, are cut successively from within outwards. Removing next a band of integument around the cranium, the whole upper part is removed by small pieces, and the head being thus widely open, the whole mass of soft organs contained in the cranium, and which envelop the ganglia, are to be detached either with the scraper, scalpel, or a curved needle, by cutting the maxillary, lingual, labial and antennal nerves at their entrance into these organs. The optic nerves are cut near to the orbits, but most frequently they may be torn from the latter without much injury.

The whole mass of soft parts contained in the head being thus detached in a single parcel, are fixed upon a black plate of cork, and the parts not belonging to the nervous system are removed in small pieces from the latter, which is thus easily disengaged.

## CRUSTACEA.

660. DISSECTION.—The methods employed for preparing the nervous system of Crustaceans are, in general, the same as for the Myriapods and Insects. It need only be remarked, that the shell being very frequently extremely hard the body cannot be opened with the slice, but the chisel, or even for very large species the osteotome must be used. If it is merely intended to see the nervous system, the trunk and abdomen may be opened without any great manipulation by removing completely the superior half of the body. For the head, on the contrary, more care must be taken; the brain, as usual, being placed above, but always, however, immediately beneath the integuments. As a general rule, it is placed upon the œsophagus. But it is plain, that if the latter in place of passing from the mouth directly backwards, is, on the contrary, directed from below upwards, the brain is really placed in front of this canal, and the first or sub-œsophageal ganglion behind it, and in this case both one and the other are situated deeply, as in the Decapods, and, therefore, the upper part of the head may be removed without any great care. It is sufficient to take some precautions in approaching the eyes and antennæ; but it is clear, that where at the same time the distribution of the nerves is wished to be seen, the shell only must be at first removed and the nerves traced throughout their whole course. To expose the nervous system of *Limulus*, the body of which is very much depressed, it is most convenient to open the

animal from above, by removing the whole upper scale of the buckler and abdomen.

These preparations are with difficulty preserved, from their soon becoming black.

### ARACHNIDA.

661. DISSECTION.—The preparations of the nervous system of the Arachnida may be made like those of Crustaceæ, by opening the body from above and then following the same methods; remembering well that the brain is always placed very deeply in front of the cartilaginous sternum, situated in the middle of the trunk, and that consequently to reach it all the muscles which suspend this piece must be cut off close to it, and the piece itself removed to see the sub-œsophageal neurosome placed beneath, and then to trace the series of abdominal ganglia.

But M. Straus-Durckheim prefers, at least in the Pulmonary Arachnida, opening the body from the side, that is to say, cutting it longitudinally into two parts, right and left, but in such a manner that the part preserved be larger than the other, so that the brain and ganglia remain entire. Freeing this principal half of all the fragments of divided organs, the brain and ganglia are reached, and seen *in situ* from the side, and their relations, especially with the œsophagus and cartilaginous sternum, recognized. In these preparations the position of the optic nerves, as well as those which spread within the trunk, are also well seen.

As to the crural nerves, they are cut at a little dis-

tance from the neurosomes, their origin on the one hand being examined on the latter, and their arrangement within the legs upon the other by opening them from one side, and proceeding as for dissecting the muscles and vessels.

Preparations of the nerves of large Arachnida, as *Mygale*, large Scorpions, &c., preserve perfectly in fluid.

---

### SECT. III.—MOLLUSCA.—CEPHALOPODA.

662. DISSECTION AND PRESERVATION.—The brain and sub-oesophageal neurosomes will be best seen by opening the head from the side in front of the eye. The skin and flesh covering the cranial cartilage are to be removed, and this being exposed, the optic nerve is cut with the globe of the eye attached to it from this cartilage, so that they may be turned backwards and examined afterwards separately. Some small layers should be cut from the antero-lateral part of this cartilage, so as to open the corresponding cavity of the ear, without burying the scalpel too deep, for fear of wounding the follicle representing the vestibule of the auditory nerve, which this cavity contains. After having studied this rudiment of the ear, portions of the cartilage enclosing it are continued to be cut away, until half on one side has been removed, and the brain and neurosomes thus disclosed, when each nerve is next traced throughout its course.

Preparations of the brain and nerves may be very



well preserved in collections, the parts being very large and the nerves very distinct.

#### GASTEROPODA.

663. DISSECTION.—To see the brain, the body must be opened in all the Gasteropoda from above, and near to the head, where it is found resting upon the œsophagus. In afterwards opening the body more widely, the other ganglia are easily enough disclosed by tracing the nervous trunks which fasten them to the brain. But to prepare the neurosomes, the œsophagus must be very cautiously cut at a certain distance from the brain, so as not to injure those inferior ganglia, which frequently adhere very closely thereto. When once the position of these enlargements, and the nerves which supply the œsophagus have been recognised, the latter is cut near to the brain, to be turned back and disengaged from all around the adjoining ganglia and nerves; and lastly, it is to be removed altogether, to see the entire assemblage of the central part of the nervous system.

664. PRESERVATION. — The preparations of the nerves are made ordinarily, at the same time as those of the viscera, and are preserved along with them, as a single anatomical specimen in fluid. Care must be taken to use uncontracted individuals, obtained so by the methods indicated in the chapter upon preparing their muscles.

#### ACEPHALA.

665. DISSECTION.—When it is wished to prepare the nervous system of the Acephala, it is commenced

by removing entirely, as for every other dissection of these Molluscs, one of the two valves; the mouth is sought for in the anterior commissure of the mantle, a small probe introduced into it to mark its position, and a portion of the mantle, which is found around the anterior closing muscle of the valves and above the mouth, being removed, the brain, from which the different nerves are to be traced, is at once hit upon. Under the closing muscle, and ordinarily, immediately beneath the integument, the inferior ganglion will be found in the same way, and the collar of the œsophagus, or rather, the two long cords which take its place, will be easily traced from one to the other.



#### SECT. IV.—*RADIATA*.—ENTOZOA.

666. DISSECTION AND PRESERVATION.—To prepare the nervous system of the Cavitary Entozoa, the body must be opened from the side through its whole length so as not to injure one of the two trunks, and the viscera removed, the extremities of which are to be examined with special care, to be assured that no part of the nervous system there met with is destroyed. But care must be taken, according to M. Otto, to choose fresh individuals, since in them alone can the nervous system be distinguished, since it entirely disappears in those which have remained long in alcohol. They should be allowed to remain for some time in fresh water, which by infiltrating the body, renders it more transparent. By cautiously scraping afterwards the interior of the body

with a sharp instrument, the soft spongy part covering the nerves, being softened by the water, is easily removed, and the latter become very apparent.

667. The nervous system of the Parenchymata must be traced, like all the other organs, by means of a scalpel; but it may also be very well perceived without dissection in *Fasciola*, by examining it through the integument. To render it more distinct M. Otto recommends likewise using only a fresh specimen, the intestinal cavity of which is slightly filled with food. They are, in like manner, to remain some time in fresh water, to render their body more transparent, and placed upon a plate of glass to be viewed with a lens in clear daylight. These animals may be dried upon a plate of glass, and, when well dried, are rendered transparent by coating them over with essence of turpentine. It is in this state that these preparations may be very well preserved, and the above method is also indicated by the same anatomist.

#### ECHINODERMATA.

668. DISSECTION.—To see the nervous threads of the *Holothuria*, the integument surrounding the head must be removed upon one side, to expose the tentacles throughout their whole length, and the latter lifted up to see their attachment to the cartilaginous ring, where the threads which are distributed to them are disclosed. For the *Echinus*, it is always by cutting the shell horizontally in two, as for all the other internal organs, that the nervous threads will be disclosed; but it must be

opened from the side to seek for the central trunk, which without doubt surrounds the mouth.

The nervous system of *Asterias* is prepared, according to M. Tiedemann, by removing from below the integument which surrounds the mouth, proceeding, nevertheless, with much precaution, so as not to destroy subjacent parts. According to Spix, on the contrary, the body must be opened from above.

These preparations can seldom be preserved.

#### POLYPI.

669. The nervous system of *Actinia* should be prepared by raising the integument from the roots of the tentacles, when it may be detected running round the latter, imbedded in a strong circular band of muscle which surrounds the orifice of the stomach.

---

## CHAPTER XIV.

---

### ORGANS OF THE SENSES.

---

#### SECT. I.—*VERTEBRATA*.—MAMMALIA.

670. DISSECTION.—The sense of *touch* being seated in the skin, where it resides in the nervous papillæ which project upon its surface, the latter are prepared at the

same time as the other parts of the integument. For this purpose, the epidermis which envelops them is first separated by scalding the skin, or macerating it for some time in water. In removing afterwards the epidermis, which is readily detached, the papillæ which project upon the dermis are found.

*Taste* also resides in nervous papillæ, which are especially distinct upon the tongue, and which may be disclosed by the same methods.

As to the sense of *smell*, from its residing in the pituitary membrane, upon which numerous branches of the olfactory nerves expand without forming any special apparatus, not even apparent papillæ, the preparation of its organ is reduced to a simple dissection of tissue and investigation of the nervous ramusculi; for which object, it is sufficient to detach some parts of the parietes of the nasal fossæ, especially the turbinated bones and the anfractuositities of the ethmoid, and examine their surface under water with the lens. The specimen may be scalded to remove more easily the epithelium, so as to expose the nerves.

671. Preparations of the *internal ear* are much more difficult to make, the acoustic apparatus being not only very complicated, but lodged moreover in the interior of the hardest bone in the body. The bones being nevertheless much more tender and spongy in young than in old subjects, and this part of the apparatus being nearly as large and well developed at birth as in the adult, it is principally upon very young subjects that it is to be exposed for the purposes of study.

To see best the interior of the *tympanum* and the

mastoid cells of the Carnivora, animals in which the ear is most developed, a horizontal cut should be first made with a fine saw in the cranium (in that of a *Cat*, for example, as typical of the order) in an individual in which ossification is completed, and the membrana tympani perfectly entire, so as to divide the drum about  $\frac{1}{25}$ th of an inch below the external auditory foramen, and removing thus a large part of this osseous dilatation, the tympanum and mastoid cell are at once opened, and the interior of the latter, which forms a wide cavity, is particularly well seen. The partition which separates the two cavities, and the position of the cochlear fenestra, placed in the genus *Felis*, so as to communicate both with one and the other, is also seen. This partition is cut away in small pieces, as well as the infra-posterior half of the tympanic cavity, after having cautiously detached the tympanum with a fine scalpel from all that part of the cavity which is to be removed, so that in taking it away the tympanum may not be dragged about, which would easily cause displacement of the malleus. By this proceeding the ossicles of the ear, which are very frequently found quite in their place, are disclosed, as also the under part of the petrous bone, where the promontory, the two fenestræ, and the digital depression, in which the Eustachian muscle or tensor tympani is attached, are seen.

672. To see the *muscles* of the *ossicles* the same cuts should be made upon a fresh skull, from which care should be taken not to detach the pterygoid apophysis, and the laxator tympani major muscle. The tympanum being opened, the tendon of this last muscle will

be seen to pass to the apophysis of the petrous bone, and adhere by its posterior border to the Eustachian tube, into which a probe should be introduced from its guttural orifice, which is placed above the apex of the pterygoid process, near to the body of the sphenoid, and made to pass out by its internal opening, which cannot however be easily perceived until after the malleus has been removed. In front of the promontory in *Felis* the Eustachian muscle will be seen, but with difficulty, being placed deeply above the malleus, which conceals it, and in front of the promontory, by which it is hidden from behind. By removing cautiously and in small pieces the posterior part of the squamous bone, without going in front beyond the level of the vestibular fenestra, for fear of detaching the incus, which articulates there with the squamous and corresponding portion of the mastoid bone, the external part of the aqueductus Fallopii, through which the facial nerve passes, is first opened, and turning this nerve outwards between it and the apex of the promontory, the pyramidal cavity for the lodgement of the stapedius muscle is disclosed, but care must be taken not to remove the external wall of this cavity, in which the horizontal semi-circular canal passes. That portion of the squamous bone which forms part of the box of the tympanum is then to be carefully removed, to effect which, a knife or file will be used for shaving away the bones by degrees, so as gradually to approach the external process of the incus, which must not be detached from the squamous, but the latter worked away close to the process; in this way all the ossicles will be seen exposed.

To see the interior of the *labyrinth*, each of its cavities must be separately opened, and for this the petrous bone is isolated. In the external contour of the pyramidal cavity is found the horizontal semi-circular canal, which will be opened by scraping down the external border with a file or very sharp scalpel. Being once opened in the middle, a probe is introduced into its two branches to see their direction, and they are then traced to their entrance into the vestibule.

The superior semi-circular canal is found likewise in the projection, which circumscribes within the depression remarked on the internal superior surface of the petrous bone, above the internal auditory foramen. Lastly, the posterior semi-circular canal is hid in the interior of the petrous bone, passing from the horizontal to the superior canal, both of which being opened it will be easily found.

673. It is difficult enough to disclose these canals by *carving* the petrous bone in an adult human subject, but very easy in the fœtus or infant, at the period when these canals are of ivory substance, and the enveloping portion of the petrous, of cellular.

674. To open the *vestibule* most conveniently, the petrous bone in the Cat is cut into two portions with a very fine saw, the line of incision passing as near as possible behind the two fenestræ without cutting them, and on the opposite surface also about  $\frac{1}{25}$ th inch behind the internal auditory foramen. In the posterior piece, the four orifices of the semi-circular canals should be pierced, and upon the anterior will be seen the orifice of the vestibular fenestra.



The *cochlea* must be opened by the inferior surface of the promontory. A cut with a saw should be made across the latter, parallel to the plane of the cochlear fenestra, and at a small distance from it, so as to leave simply the ring of this opening. The middle of the vestibular fenestra is approached with the saw, at a distance equal to its diameter, so as not to cut into the spiral partition, and the saw is then driven in upon a level with the centre of the cochlear fenestra. A second incision should be made along the infra-posterior face of the promontory, parallel with, and about  $\frac{2}{5}$ ths of an inch from the internal edge of the petrous bone. The bone being curved, care must be taken to make the saw penetrate at each point, only just enough to pierce the cavity, and the incision is extended to the meeting of the oblique groove which marks the separation of the spiral turns of the cochlea. A third cut with the saw, behind this groove, should be directed from the second towards the anterior border of the vestibular fenestra, which is to be approached at a distance of  $\frac{1}{5}$ th of an inch; lastly, the extremity of this incision is united to that of the first by a small furrow made with a graver, so that, in causing the small piece thus circumscribed to spring up, the ring of the fenestra is not broken. By removing this plate of bone, the last whorl of the cochlear cavity, that is the largest, is opened; and to open the first also, a semi-circular piece is removed from the inferior aspect of the projection of the promontory placed in front of the scala, which separates the two turns of the spire. The apex of the cochlea being found in the centre of this projection, a line is traced proceeding

from the middle of the vestibular fenestra to this centre, and a stroke with the saw made about half a line behind and parallel to the above, without penetrating into the cavity. This cut will form the diameter of a semi-circle. A second should be made cautiously also in front of the fossa, which separates the two whorls of the spire, so as barely to pierce the thickness of the bone, and lastly, a third parallel to the supra-posterior aspect of the petrous bone; then uniting the anterior extremities of the two first cuts, the piece should be removed in small bits. The two openings being once made, are enlarged as is thought proper, by working down the edges.

To see the canal which traverses the thickness of the lamina spiralis, separating its two scalæ, a cut perpendicular to the columella has only to be made in it.

As to the other Mammalia, the proceedings are nearly the same.

675. To trace the *acoustic nerve*, the fresh petrous bone of a rather young specimen must be chosen, so that the bones are not too hard; the same pieces are removed at first as in the preceding preparation, and nearly half of the cochlea being afterwards cut away, the umbilicus is lastly opened lengthways, where the acoustic nerve is found and its branches traced. But it will be better still to cut the petrous bone from its internal border, and through its whole length, removing the bone little by little, to a plane passing by the lower border of the cochlear fenestra, the middle of the internal auditory foramen, and the apex of the petrous bone, taking care not to cut the portio mollis of the seventh pair itself. By this means, the two scalæ of the last whorl

are first opened, then those of the first by making, towards the apex of the petrous bone, a second incision to form an angle with the first, and bending outwards towards the apex of the spire.

676. The *external organs* of the globe of the *eye*, are prepared exactly like other analogous parts formed by integument and muscles. As to the lachrymal gland, which is easily disclosed in the supra-external angle of the orbit, its excretory canals being very delicate are not easily detected: a method, however, indicated by Winslow succeeds very well; he advises soaking the lid some moments in cold water, and having withdrawn without drying it, the external part of the palpebral conjunctiva is blown into, very closely but without touching it, with a fine pipe at different places. In this manner, the extremities of these small tubes are inflated and rendered visible, and once disclosed, may be readily injected.

The puncta lachrymalia are perceived by turning the eyelids inside out, and fine probes may be introduced into them, or they may even be injected. In the first case, their direction must be rendered straight by drawing open the eyelid, which is difficult to do, so that it is better to inject them, as by this means the lachrymal sac as well as the nasal canal are filled, and can be dissected afterwards to see their form and position. This conduit may be also injected by the nasal fossa, upon a head divided longitudinally into two parts, where it is found beneath the posterior part of the inferior turbinated bone.

677. To see the *muscles* of the globe of the eye, two

methods may be adopted. The first consists in removing the whole external wall of the orbit, and studying successively the external, inferior, and superior muscles, to cut them through the middle, and remove afterwards the globe to see the attachment of the internal muscle. The eyeball being removed, the insertion of these muscles round the optic foramen will be distinctly seen. The second method employed, when it is wished to preserve the head intact, is to detach in a single mass all the soft parts contained in the orbit. Having reached the bottom of this cavity, the muscles and optic nerve are cut through together by means of a curved-bladed scalpel. This process is difficult, and the organs situated in the ball are commonly sacrificed, being destroyed by the traction and compression that is exercised upon them.

678. As to the parts which constitute the ball itself it would be difficult to see them well while the organ remains *in situ*, and it is always extracted, so as to be examined more at leisure; to this effect it may be fixed separately upon a piece of cork, but in this state much difficulty is still experienced in dissecting it, while at the same time being entirely composed of soft parts, it becomes distorted and easily crushed when opened.

For dissecting the eyes more conveniently, it has been contrived to freeze them, to give their mass greater consistence, and in that state to cut them in the required direction. But besides the inconvenience of its being possible only to employ this proceeding in winter, and then not always, the globular form of the organ prevents its being readily kept in place. All these inconveniences

disappear by the employment of the anatomical moulds described in the first part of this work (§ 52).

The eye is first extracted from its orbit, endeavouring to compress it as little as possible, so as not to destroy its internal parts, such as the hyaloid membrane, ciliary processes, iris, &c.

The fat and cellular tissue being stripped off, and the eyeball only left, it is moulded in fine plaster, beaten up to the consistence of cream, being immersed therein more or less deeply, according to circumstances. As this matter does not attach itself to the body of the eye, the latter may be artificially fixed by means of small hooks made of very fine pins, as has been already pointed out. By this method the eye is not only fixed, but does not lose its form when dissected. With a very thin slice a layer of the sclerotic is removed, and the whole interior is seen in the most convenient and distinct manner, especially under water, where this apparatus is best dissected.

The layers which compose the *cornea* may be most easily separated after it has been soaked for some time in warm water or alcohol.

To see the walls of the cells of the hyaloid membrane, it is also recommended to macerate the eye in alcohol or weak acid, which renders them opaque; and that all the cells communicate with each other is proved by making a single incision, through which all the liquid will pour out and leave the cells empty.

Freezing is also used, by which the vitreous humour of each cell forms a distinct flake of ice, and is easily separated.

Bichat recommends simply placing the *vitreous body* in a solution of potash, the hyaloid membrane becoming thereby opaque and grey, while the humour preserves its fluidity and transparence.

To see the fibres which compose the *crystalline lens*, the latter should be macerated for some days in a saturated aqueous solution of alum. This salt concretes and renders the fibres hard, and the lens is then divided with the greatest ease in all directions by the cleavages passing from the centres of the two surfaces.

679. PRESERVATION.—The organs of touch or nervous papillæ, making part of the skin, are preserved along with it, but as they lose their characters entirely by drying, they must be kept in fluid, and even then they are not very well seen. The same is the case with the gustatory papillæ and the pituitary membrane. The first may be preserved, however, to see their external forms and arrangements upon the tongue, denuded of its epidermis, and the last for showing the nerves upon the pituitary membrane, and both should be kept in fluid.

The bony preparations of the middle and internal ear are preserved like the other parts of the skeleton, only care must be taken to wash them over with corrosive sublimate, so that insects may not destroy the tympanum and ligaments of the ossicles.

The eyes, containing no solid part, can be preserved in any fluid, which contains no substance which alters the albuminous organs, such as the bi-chloride of mercury and acetate of alumina. Alcohol preserves these organs best.

## AVES.

680. DISSECTION.—The sensitive papillæ of the skin and tongue, as well as the nerves of the pituitary membrane, are prepared precisely as among the Mammalia, and the eye and ear also nearly in the same manner.

To see the interior of the nasal fossæ and lachrymal passages, they must be opened from the side. After having examined the disposition of the nostrils, and that of the two folds of their borders, the lower one is cut to see the position of the one above, which forms the inferior turbinated bone, and opening the nostril more from behind, the latter is entirely disclosed terminating at the entrance of the middle meatus.

In afterwards removing the integument between the nostril and eye, the antrum Highmorianum is found immediately below, and a little higher the upper part of the lachrymal sac; but in order not to cut the partition which separates them, the first of these cavities only should be opened below a line passing from the nostril to the inferior border of the eye, and this opening enlarged in front, towards the descending process of the nasal bone, backwards to beneath the globe of the eye; above, this cavity terminates in the angle formed by the integument with the partition, which separates it from the lachrymal sac.

In the floor of the antrum, in front of the eyeball, are seen the entrances of the sphenoidal and frontal sinuses.

Raising then the integument from over the partition, the lachrymal sac is opened, into which a probe may be

pushed, and made to pass out by the posterior nares, and, in front of the orbit, are found the orifices of the lachrymal canals.

Cutting next the descending process of the nasal, and the integument which separates it from the nostril, the anterior meatus of the nasal fossæ is entirely opened; and, lastly, by removing the internal partition of the antrum Highmorianum and lachrymal sac, the middle and superior meatuses are opened.

681. As to the labyrinth and its appendages, they are easily prepared, the bones in which they are hollowed out being very spongy and admitting of being readily cut with a knife. The cranium of an old bird may be very well used, but young ones however in which the sutures are more distinct are preferable, the part in which each cavity is placed, being better recognised.

The dissection is commenced, by separating in a single piece the whole posterior half of the cranium, sawing the latter in two by a vertical cut, passing in front of the sphenoid so as to leave the Eustachian tubes intact. In the *common fowl*, for example, upon a specimen thus prepared, the superficial table of the upper bones of the cranium is first removed to see in the middle of them, the cavernous cells of the diplœë; opening these in succession by very fine layers, the semi-circular canals placed in the supra-posterior part are disclosed without fail, and are to be freed from the spongy tissue that covers them, by scraping lightly. Removing next the whole upper and internal part of the parietal and squamous bones, as far as the superior vertical semi-circular canal, the prominent arch of which



is seen within the cranium, where it circumscribes a deep cavity, this canal is opened, first along its upper border, by removing it in small slices, and then as soon as its cavity has been penetrated, a bristle is introduced to recognise more exactly its direction. The same is done with the two others, and the position of the probes which pass into the vestibule beneath, show the situation of this cavity which is opened from the internal aspect, after having cut the piece into two lateral halves. The cochlea situated lower down, more internally than the vestibule, and hidden in the inferior bones of the cranium, is next opened also.

It is to be opened from the upper surface, so as to see at once the interior of the two *scalæ*. All the parts of the labyrinth being thus disclosed, the piece may be replaced upon the head, from which it has been removed, by dividing with a saw the basilar and sphenoid bones, which will serve as a guide to seeing better what the position is of each part in relation to the cranium.

682. As to the eyes, the same methods will be adopted as for the *Mammalia*; it being only remarked, that for seeing the marsupium the eyeball must be opened by its anterior or posterior surfaces—in other words, perpendicularly to the cornea.

#### REPTILIA.

683. The bones which envelop the labyrinth being only partially ossified, and membranous throughout the rest of their extent, it is necessary to have fresh subjects for making preparations.

As to preparations of the eyes, they are made as for the Mammalia.

#### CHELONIA.

684. Preparations of the eye and ear are made exactly as for the other classes of Vertebrata.

#### PISCES.

685. DISSECTION.—The only preparations that can be made upon the nasal fossæ of Fishes, consist in opening them from the side to see their interior, and tracing the nervous branches placed in the folded ridges.

To see the internal ear the cranium is opened from above, and the labyrinth exposed, either in the infra posterior part of that cavity, or in a special cavity placed upon the side of the posterior part of the cranium.

The eyes are prepared like those of other Vertebrata.

All these organs of sense should be preserved in fluid.



#### SECT. II.—ARTICULATA.—ANNELIDA.

686. DISSECTION.—The only preparations that can be made of the sensitive organs, consist in tracing the different nervous trunks which pass into parts where these organs are supposed to be placed, especially those of the brain, of the first inferior and the posterior ganglion of the ventral cord, the last appearing to furnish nerves of sense in the higher Articulata. By this means it may

be investigated, if the part to which a large nervous trunk is given can be the receptacle of a sense.

#### MYRIAPODA.

687. Preparations of the organs of sense of the Myriapods are made like those of Insects.

#### INSECTA.

688. DISSECTION.—The preparation of the sensitive organs of insects is excessively difficult, partly from their extreme minuteness, and partly because they are generally clothed in a horny integument which must be cut into.

As concerns the feet, antennæ, palpi, and the multi-articulate appendages, to the last segment of the abdomen in certain Insects (*Lepisma*, *Gryllotalpa*, *Ephemera*, &c.), the best mode of preparing them is to imbed them in a mass of wax, where they are fixed firmly enough to admit of a layer of their integument being removed with the *slice*; but care must be taken to cut in the direction of the extremity towards the base, if there are muscles, so that they may not be swept back; and *vice versa* if there are none, the cut being easier to make in that direction.

689. To examine the rings of the stigmata they may be removed with an adjoining portion of integument, of which they are appendages, and brought under the microscope. But if it is wished to prepare them *in situ*, to see the nerves which pass to them, care must be taken to move the segments as little as possible upon each other, so that the organs adjacent to the stigmata

may not be torn, as happens very easily, and the more so from the latter being often found in the bottom of a fold which the abdomen makes laterally, in its membranous longitudinal bands.

The best mode is to detach at once upon an entire insect the lateral part of the thorax and abdomen, beginning by making an incision in the integument along the back and belly, cutting next slightly with the scissors all the internal organs to complete the separation of the longitudinal lateral part of the body, and bringing it afterwards under the microscope, having fixed it with pins upon a cork. Removing next by bits all the remains of organs which cover the stigmata, they are at length entirely exposed with their rings, and the trunks of neighbouring nerves. But care must be taken to exercise no considerable traction upon the adjoining parts, for fear of tearing the nerves to be preserved. M. Straus-Durckheim recommends these precautions, for in spite of the care used, he has never been able to trace the nerves to the bottom of the folds in the integument, where the stigmata of *Melolontha* are placed.

It is probable according to the same authority, that in the first pair of stigmata placed between the neck and pro-thorax, the olfactory apparatus is principally to be met with, these stigmata, with their accompanying rings being usually the largest.

690. The eyes are however the most difficult parts to prepare, from the extreme minuteness of the ocelli. To see these last well, a very fine slice must be cut with a well sharpened instrument, such as a razor, from within outwards, from a compound eye, without much

sawing, and at a single stroke, so that the cut may be parallel to the simple optic nerves between which it passes. This lamella is brought under the microscope, where it is kept by means of the forceps (¶ 178), fixed on a portion of the common optic nerve. The superficial bruised parts are removed from either side, to expose the simple optic nerves with their respective eyeballs, which have not been injured.

691. To see the distribution of the nerves in the interior of the organs of the mouth, the latter must be opened by cutting towards the buccal surface in which the last nervous ramuscles expand, in other words, in the mandibles and maxillæ, from without inwards; from the lip the lower plate is removed to trace the nerves beneath. The tongue is prepared likewise from beneath, where it is naturally open. Lastly, to see the nerves of the labrum, the upper integument should be removed.

#### CRUSTACEA.

692. DISSECTION.—The methods employed for preparing the organs of sense in the Crustaceans, are precisely the same as for Insects. The eyes being very often much larger, are more easily dissected. The cornea, composed of all the lenses united into one, may be most readily preserved dry, and the crystalline lenses are very distinctly seen projecting upon the internal surface.

#### ARACHNIDA.

693. The sensitive organs of the Arachnida being

quite like those of Insects and Crustaceans, are prepared by the same means; and it need merely be remarked that in the simple eyes, which are much larger than in these two last classes, much more facility is offered for their dissection, and especially in the large eyes of the *Scorpion*, in which animal their structure may therefore be studied.

~~~~~

SECT. III.—*MOLLUSCA*.—CEPHALOPODA.

694. DISSECTION.—The acoustic nerve and eye of the Cephalopods may be dissected in the same way as their analogues in the Vertebrata, and are even more easily prepared, the cranial cartilage in which they are lodged, admitting of being easily cut with the scalpel.

695. To see the different coats which form the eye and its appendages, the lids should be first inflated by means of a pipe to detach them from the eyeball, where they rest upon it. The same should be done for the sclerotic, by blowing into its aperture, and lastly for the iris. After having well recognised each of these parts, they are slit in different radiating directions, so as to turn back the strips, and distinguish the parts placed beneath. The sclerotic is next disclosed, as far as the cranial cartilage, and its external layer opened all round it to see its cavity, in which the optic ganglion and glandular mass are found. Lastly, the internal sclerotic is opened to see the retina and choroid.

The lamellæ and fibres of the crystalline lens are

very well seen in eyes which have remained some time in alcohol, and by tearing off strips of the external lamellæ, it is distinctly perceived that they are prolonged upon the ciliary processes.

GASTEROPODA.

696. DISSECTION.—The organs which are supposed to preside over the senses in the Gasteropods, are prepared at the same time that their nervous system is dissected.

In *Limnæus*, *Limax*, and *Helix*, the acoustic cells will be found adhering to the posterior part of the anterior ganglions of the great sub-œsophageal mass. They are easily recognised by submitting the head of the smaller species of Gasteropods, or of the young of the larger species, to a gentle compression under the microscope.

697. The organs of sense, with the exception of the general one of touch, are either wanting entirely, or too imperfectly defined in the lower orders of Mollusca and in the Radiata, to merit a distinct notice.

It will be evident at once to the student, in perusing these details relative to the methods of dissecting and preserving the different systems of organs, that all the information which they embrace can be regarded only as consisting of so many general rules for his guidance in prosecuting such researches. More minute directions

would have been incompatible with the extent of a work like the present, and in many respects unnecessary, since every observer will vary more or less his modes of investigating the same animal according to the end proposed, while to each the lessons acquired by practice, by familiarizing the eye and hand with the objects of nature themselves, will be worth, indeed, the most elaborate and complicated descriptions, which, if not fully understood, and this is often by no means easily done, serve only to confuse. Still less would it have been possible to convey in writing a clear idea of the spirit in which anatomical studies should be pursued; that the individual importance of facts, each being viewed as parts in the great scheme of organization, will be in proportion to the truths they are rendered capable of illustrating, or the deductions to which they lead. Hence much philosophy of thought, as well as judgment, are requisite to interpret accurately the evidences of the senses; and thus it is the sciences of Comparative Anatomy and Physiology have attained their present elevated position, and in like manner will continue to advance.

APPENDIX.

ON THE DREDGE.

Communicated by Professor Edward Forbes.

THE Dredge is an instrument indispensable to the naturalist engaged in the investigation of marine animals and plants, as without it the most interesting of the Invertebrata will be sought for in vain.

The common oyster dredge is the usual form ; but it is large

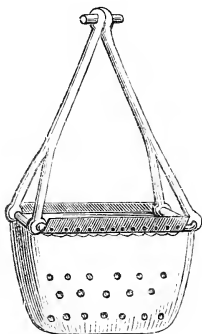

and clumsy, and requires some little skill in its management, especially to prevent its *canting* when it reaches the bottom, which

defeats the object, and exhausts the labour of the dredger, since from its construction it can *scrape* only on one side. A distinguished Irish naturalist, Robert Ball, Esq., of Dublin, has constructed a dredge, the form of which remedies this inconvenience, and which, from its efficacy and portability, is by far the best suited to the purposes of the naturalist. It consists of two parallel oblique pieces of iron scrapers, united together at each end by cross bars, to which are attached two arms by means of swivel joints. These arms fold down when not required, and when the dredge is to be used they are elevated, until their free extremities meet so as to form a triangle with the scraping frame, when they are to be screwed together. The rope is to be attached to them at the screw. To the scraping frame is attached (by holes and cords) a bag, either of strong rope network or of canvas, with eyelet holes. In deep water the latter is preferable, in order to secure as much of the sea bottom as possible. Such a dredge may be made of any size; but the most convenient are of 3 feet frame, and of 18 inches. The former is quite large enough, and may have a gape of 6 inches. The latter is very convenient, as it may be packed up and carried any where in the bottom of a carpet bag, and requires for use only a coil of strong thick cord.

The dredge should be let down with care, so as to avoid any entangling of the rope, and the bottom, if not known previously, should be ascertained by the sounding lead before dredging. Generally speaking, one-third more line than the depth is required for the operation. If the dredge be too light, or if there be a great depth of water, a sounding lead should be attached to the line just above its junction with the dredge, in order to sink and steady it. When great accuracy is required (and always, if possible, in very deep water), Massey's sounding machine should be used to register the depth.

When the dredge is drawn to the surface full, the contents should be emptied into a tub or bucket, and washed with care. Mr. Ball recommends a series of sieves of different degrees of fineness for the purpose. A careful search should be first made for soft animals, such as *Nudibranchia*, *Holothuriæ*, &c., in order that they may be procured as uninjured as possible. They should

be immediately placed in a vessel of clear sea water, and their actions closely watched. Then such Radiata as are not required for observation should be plunged into a vessel of cold fresh water, from whence, after soaking for an hour or so, they should be taken, and plunged for a few minutes in boiling *fresh* water, and then dried in a draft. If, however, the forms are novel or interesting, spirit and Goadby's solution are the best media for their preservation.

After each dredging operation, a note should be taken of the animals procured, and the state in which they were found, whether alive or dead; and if *Conchifera*, whether the dead specimens had the valves attached or single, &c.; also, the depth of water, the distance from shore, the nature of the sea bottom, the fuci procured, and the date, should be all accurately registered.

In putting away specimens in spirit at sea, I have found that by far the best method for their safe preservation is to wrap each in a fold of tin foil, on which a mark may be attached or cut referring to a register.

I need not insist on the importance of as many notes as possible, and above all sketches, being made from animals immediately after their capture.



MEANS OF REMEDYING THE DEFECT OF ARTIFICIAL LIGHT.

By Dr. J. W. Griffith.

It is well known to microscopists how much more fatiguing it is to view minute objects by artificial than by natural or daylight. Many are by this means prevented from resorting to the microscope in the evening, which is the only time most observers can spare for such purposes. When candle or lamp-light is compared with daylight, it is found to be of a reddish-yellow colour compared with the latter; the combination of this coloured light with the colour complementary to it, produces a white compound, which is equally as good as daylight. The complementary tint to this reddish-yellow is deep blue, with a tinge of purple or green, according to the exact tint of the luminous source, which varies. The

readiest mode of finding out the exact tint, is to fit the polariscope to the microscope; then to place in the stage some crystallized salts, belonging to any other system than the cubic; next to arrange the analyzer and polarizer, so that their planes of polarization are at right angles. By examining thus several crystalline specimens, a portion may be always found which is of exactly the same colour as that of the flame (which must be found out by comparison); by then turning round the analyzer, so that the planes of polarization become parallel, the complementary blue tint will be found, and a piece of glass of this colour will be the requisite one. The modes of applying this are various. Some substance soluble in tallow supplying the requisite tint during combustion, may be added in the formation of the candles; or another head may be added to the illumination of opaque objects, and a plate of glass of the proper colour fixed in it, this being placed as near the light as possible, and between the mirror of the microscope; or a piece of coloured glass may be fixed in the condenser ordinarily used for transparent objects; or the lamp glass itself may be made of the requisitely coloured material. The method of proving if the tint be the right one, is to adapt it to the apparatus during daylight, using a candle as the luminous source, and then comparing the field with the white sky.

ON MOUNTING PREPARATIONS UNDER THIN GLASS.

By Dr. J. W. Griffith.

IN consequence of many of my specimens having been spoiled by using gold size and lamp black, I was induced to try a variety of other compounds, and I have at last, I think, found one or two which will perfectly answer. I first tried a solution of asphalt, by heat, in oil of turpentine, as used, I believe, by Dr. Williams of Guy's Hospital. This I found also to fail. Those which I have found answer permanently are—1st, a solution of Canada balsam in ether or oil of turpentine, evaporated to just such a consistence as is sufficient to allow of its being applied with a camel hair pencil; 2nd, a mixture of gold size and white lead; this used as

the ordinary gold size and lamp black has remained permanent; a little red lead mixed in with it makes it dry quicker and harder; 3rd, a mixture of red lead and gold size used immediately dries very rapidly, and becomes very hard; and 4th, a mixture of fine lamp black and white hard varnish, laid on immediately, forms a very good compound. In some cases where I have been particularly anxious to preserve a specimen in the moist state, I have made the walls of the cell of Canada balsam, next laid in the specimen and its liquid, and finally cemented the margin of the thin glass firmly, by melting the balsam with a heated pen-knife or iron nail. The 1st, 4th, and last, are those in which I place most confidence, particularly the 1st.



UPON THE METHODS OF EXAMINING THE CIRCULATION AND
NERVOUS SYSTEM IN LIVING ANIMALS.

COLD blooded animals are by far the best subjects for enjoying the beautiful spectacle of the *circulation* for a length of time, and without interruption. In what follows I shall say as much as I think necessary to enable every one to undertake such observations most conveniently, and to avoid inflicting needless pains upon the subjects of them—a duty incumbent upon every physiologist, who ought to feel that vivisections are only allowable where they are unavoidable. Every season of the year is not alike favourable for making observations on the circulation. It is only in the spring that tadpoles are to be had, but they are excellent subjects. They should be rolled up in moist blotting paper nearly to the end of the tail, and so laid upon a plate of glass of sufficient size, and placed under the microscope, the wrapper of bibulous paper being kept constantly moist by a few drops of water let fall on it from time to time. In this way the circulation may be watched for hours, and the tadpole set free at the end of the observation is nothing the worse. Young and still transparent fishes may also be treated in the same way, and are excellent subjects, but they require more delicate handling than tadpoles. The circulation in the allantois of the young embryos of lizards and snakes is also a

very beautiful sight, when these subjects can be had at the proper point of evolution; they require to be removed from the ova, and observed covered with fluid albumen in a watch-glass. In the winter I find frogs the best subjects; fishes are then much less proper. In the web of the hind foot of the common frog (*Rana temporaria*), the circulation is perhaps seen to as great advantage as any where. All our better microscopes are now provided with a stage adapted for placing the animal, which is best secured by being put into a linen or calico bag, with tapes at each corner to tie it down by. If the stage have a piece of soft wood, with a round hole pierced in it, the web is more readily and more advantageously secured over this by being pinned down in its circumference, than by threads passed round the toes and braced out in different directions. The web ought of course to be kept constantly wetted with fair water. The mesentery of the frog, or of a small warm blooded animal, such as a mouse, the wing of the bat, &c. &c., are, on grounds readily conceivable, much less favourable subjects for observation. To obtain a view of the entire embryonic circulation, the incubated hen's egg of the third and fourth day should be chosen. The shell being carefully removed on the lateral aspect of the egg, the germinal membrane must be cut away from the vitellus, at the distance of a few lines from the sinus terminalis, and gently placed in a watch-glass, with a little water warmed to blood heat, and having a few grains of common salt dissolved in it. The adhering particles of the yolk are then to be washed away, and the water renewed, the temperature being carefully kept up all the while by the addition at intervals of a drop or two of warm water. To observe the circulation in the respiratory system, the larvæ of the water newt may be selected to show it, as it takes place through gills, the branchial fringes being beautifully transparent here. The best subjects for observing the circulation through the lungs—a magnificent spectacle, though it unfortunately lasts but for a short time—are strong large newts. The animal should be strangled after it has distended its lungs, the noose being pulled with moderate tightness. The abdomen is then to be laid open, and the entire animal being held in the hands, is placed upon a glass plate as a *port-objet*, and one of the

lungs brought into the field of view. To obtain a sight of the circulation in glandular organs, the larvæ of water newts are still the best subjects; to observe that of the liver, in particular, simple lenses, or low powers with aplanatic eye-pieces, when the compound microscope is used, should be chosen. When we would examine the circulation in transparent parts, magnifying powers of from 100 to 200 diameters are preferable; but to obtain a satisfactory general view of larger parts, we cannot go beyond a power of from 40 to 50 diameters. To scrutinize individual appearances, we frequently mount to powers magnifying 400 and 500 (and even 800) diameters.

The blood of frogs is best obtained by collecting it from the heart of one or more of these animals in a narrow test glass. The fluid is then to be stirred with a fine glass rod, by which the fibrine will be coagulated and made to fall in flocks, or to attach itself to the rod in the form of a membrane. The blood corpuscles soon sink to the bottom through the serum, which then presents itself as a yellowish fluid. The blood can be preserved in this state for several days in cool weather.

For opening the *spinal canal* in the frog, it is necessary to have a pair of cutting pliers of suitable form and strength, by which, after the removal of the muscles, the vertebral arches and upper part of the skull may be broken away, or the bodies of the vertebræ themselves removed from the front. For mechanically irritating the roots of the nerves, or the surface of a transverse section of the brain and spinal cord, a curved and fine needle, set in a handle, will be found useful, as also for lifting up the roots of the spinal nerves, previous to cutting them across. Scissors of different form and size, with fine points and edges, must be also at hand. Stilling makes use of a very small but strong pair of scissars with short blades, bent at an angle to separate the vertebræ at their articulations, and from the arches, and to cut through the spinal column. To open the skull quickly in the rabbit, and remove at once a part of the brain, Stilling uses a strong sickle-shaped knife, like a gardener's pruning knife. A very suitable, and in many cases indispensable, instrument is a small scalpel, with which the coverings of the head can be penetrated, *e. g.*, in

the rabbit, in order to cut through the roots of the cranial nerves upon the living animal, with the least possible injury to other parts. As chemical agents of irritation, recourse is had to caustic potash, and acetic acid, which generally succeed tolerably well. The abdominal ganglia, *e.g.*, and twigs of the sympathetic in the rabbit, being seized with the forceps, are touched with a small piece of the potash. Acetic acid is an excellent means of irritating different parts of the skin of the frog. It is used in a more or less concentrated state, and applied with a glass rod to the spot to be irritated. Galvanic apparatus are of very great importance, and by far the most convenient is a single pair of plates. The following form is the most suitable:—A long, fine pointed, and well polished plate of copper, is connected to a zinc plate by means of a loop of silver or silvered copper wire, so that the two poles may be approximated, either within a very small space upon the root of a nerve, or the circuit established between parts removed at some distance. The fine pointed copper plate can also be employed for mechanical irritation. This feeble apparatus is capable of exciting the most powerful muscular contractions in the whole of the hinder extremities in living or fresh killed frogs, and in the rabbit, through the whole extent of the diaphragm. Galvanic experiments must be always commenced with a single pair of plates. With this the separate function of the two roots of the spinal nerves may be successfully demonstrated, while by means of a stronger apparatus the galvanic fluid may be made to traverse from one root to the other, these parts conveying it like all animal structures by acting as moist conductors. In many cases it is convenient to make use of small galvanic piles, when, *e.g.*, it is wished to test the action of the nerves upon the muscular fibres, when they have been separated some considerable time from their centres, and have therefore died by degrees. For many subjective experiments, as imitating the organs of sense, the inductive apparatus described in works upon natural philosophy, answers best.—*From the excellent Translation of R. Wagner's Physiology, by Dr. Willis.*

STILLING'S METHOD OF EXAMINING THE SPINAL CORD.

EXTREMELY thin sections of the spinal cord, longitudinal and transverse, are to be made by means of a very sharp and broad razor, rather hollowed on the surface, which, as in making other delicate animal and vegetable sections, is to be kept quite wet on the surface by spirits of wine. These sections are made in every part of the cord, from the cauda equina to the pons varolii. The state of the cord when examined is of considerable importance. The examination is made most satisfactorily on the spinal cord of an animal, a calf, or dog, for instance, just killed, the delay of a few hours causing considerable changes; but for an extended inquiry like this, it is necessary to have parts always ready, and they are thus prepared:—"I place," says Dr. Stilling, "a fresh spinal cord and medulla oblongata, as they are taken from the body, in weak spirit, and allow them to remain in it twenty-four hours; then I pour off the spirit, and place fresh but stronger spirit on the parts, which after two or three days is again poured off, and then the strongest rectified spirit is used; the specimens being allowed to remain in it from four to eight days, acquire by degrees such hardness as to allow of the finest sections being made. The sections being provided (if from a recent cord) are then to be extended by means of a compressorium, differing in some respects from the instrument usually employed. Low powers are best adapted for the examination; a lens of two-inch focus being first used, and then others of higher power." — *From the Lancet, Oct. 7th, 1843.*

A
GENERAL OUTLINE OF THE ANIMAL KINGDOM,
AND
Manual of Comparative Anatomy.

~~~~~  
BY T. RYMER JONES, F.Z.S.,

Professor of Comparative Anatomy in King's College, London; Fullerian  
Professor of Physiology in the Royal Institution of Great Britain;  
Examiner in Comparative Anatomy to the University of London.

*One thick volume, 8vo. containing nearly 350 Illustrations, £1 18s.*

~~~~~

“ We cannot, however, refuse to bestow a warm commendation on the manner in which Mr. Jones has executed his arduous task; the present manual affords the best general outline of the Animal Kingdom that we are acquainted with—it is neither too prolix, nor too concise. The ascertained facts connected with the anatomical structure of animals are collected from every available source, and arranged in lucid order; and the letter-press is illustrated with more than three-hundred wood-cuts, which will bear comparison for beauty and accuracy with the best specimens of the art, even in its present perfect state.”—*Provincial Medical and Surgical Journal*.

“ Professor Jones has collected his materials from the most authentic sources, judiciously selected those best adapted to his purpose, and arranged and combined them in a manner that exhibits a thorough acquaintance with the principles as well as with the details of his subject. We can recommend this admirable work to our readers as adapted more than any other with which we are acquainted, to furnish them with a competent knowledge of the principal types of conformation encountered in the study of the animal kingdom. The wood engravings are beyond all praise.”—*British and Foreign Medical Review*.

“ But in Professor Jones's beautifully illustrated volume now before us, comparative anatomy, in a certain sense, is brought up to the present time, and contains an accurate, judicious, and interesting account of the structure of the lower animals—such an account, indeed, as will prove most acceptable and useful to the student of natural history and comparative anatomy. It has already become the class book for comparative anatomy in some of our universities.”—*Professor Jameson's Journal*.

“These isolated extracts cannot convey any thing like a just idea of the merits of this work. It is entitled to the high character of being the first complete systematic treatise on comparative anatomy published in the English language. It is in all respects executed with great ability, and may be confidently recommended as a standard work in this branch of science. The peculiar merit of the volume of Mr. Jones, however, is, that it forms an excellent manual and guide to the student, and as such ought to be on the table of every one engaged in the study of the physiological sciences.”—*Edinburgh Medical and Surgical Journal*.

“We are convinced that no work will have tended more to diffuse a love of zoological science and comparative anatomy in the country than that before us; and we feel called upon to express most decidedly our sense of the obligations which its learned author has conferred upon the English public, by placing before the lovers of natural history so large and valuable a collection of materials. We have never seen more perfect specimens of wood engravings than many of the illustrations of the present work. This difficult task could not have fallen into better hands.”—*Annals and Magazine of Natural History*.

“Professor Jones has treated his subject in such a manner, that his work may be consulted by those who do not possess any previous knowledge of the science. * * * In the mean time we may state—and we do so without detracting from the merits of Dr. Grant’s work—that the General Outline of the Animal Kingdom, is, in our opinion, the best work of the kind in any language, and does infinite credit to Professor Jones. The well known cautious spirit of its author, the judicious selection of its materials, the just proportion of its various parts, and the admirable and highly illustrative wood-cuts, which are so liberally interspersed through it, render this work altogether indispensable to the physiological student, if he wishes to study the science as it ought to be studied, and to be able to steer clear of the many fallacies which still obstinately cling to the majority of its cultivators.”—*Edinburgh Monthly Journal of Medical Science*.

“Altogether the work is a highly meritorious one, and should be in the possession of every medical man who wishes to keep pace with the current knowledge of the department of zoology.”—*Johnson’s Medico-Chirurgical Review*.

London, 1st January, 1844.

WORKS PUBLISHED BY
JOHN VAN VOORST, 1, PATERNOSTER ROW.

Naturalist's Almanack.

VAN VOORST'S NATURALIST'S POCKET ALMANACK,
FOR THE YEAR 1844. 1s.

Aikin's Calendar of Nature.

AIKIN'S CALENDAR OF NATURE;

OR NATURAL HISTORY OF EACH MONTH OF THE YEAR.

With additions, by a Fellow of the Linnæan and Zoological Societies, and eighteen designs by Cattermole. Small 8vo., 4s. 6d.

In ordering this volume "Cattermole's edition" should be particularly expressed.

Shakspeare's Seven Ages of Man.

ILLUSTRATIONS OF THE SEVEN AGES OF SHAKSPEARE.

Drawn on wood, expressly for this volume, by W. MULREADY, R.A.; C.R. LESLIE, R.A.; J. CONSTABLE, R.A.; SIR DAVID WILKIE, R.A.; W. COLLINS, R.A.; A. E. CHALON, R.A.; A. COOPER, R.A.; SIR A. W. CALLCOTT, R.A.; EDWIN LANDSEER, R.A.; W. HILTON, R.A.

The Vicar of Wakefield.

GOLDSMITH'S VICAR OF WAKEFIELD.

With 32 illustrations by WILLIAM MULREADY, R.A. Sq. 8vo. 1 guinea.*

Gray's Elegy.

AN ELEGY IN A COUNTRY CHURCH-YARD. BY GRAY.

Each stanza illustrated with an engraving on wood, from thirty-three original drawings expressly made for the volume, by the most eminent Artists. Post 8vo. 9s.

A Polyglot Edition of this volume, with inter-paged translations in the Greek, Latin, German, Italian, and French languages. 12s.

Gray's Bard.

THE BARD. BY GRAY.

With illustrations from drawings by the HON. MRS. JOHN TALBOT.—Uniform with the Elegy of Gray, to which it forms an appropriate companion volume. 7s.

First Principles of Religion.

THE FIRST PRINCIPLES OF RELIGION,

AND THE EXISTENCE OF A DEITY,

explained in a Series of Dialogues adapted to the capacity of the infant mind.
18mo. 2s.

Illustrated Bible.

A CABINET EDITION OF THE HOLY BIBLE;

The Authorized Version. With twenty-four highly-finished steel engravings. The historical subjects from the most esteemed paintings of the Old Masters, and the landscapes from drawings by W. WESTALL, A.R.A.—In embossed binding, 10s. 6d.

Illustrated Prayer.

A CABINET EDITION OF THE BOOK OF COMMON PRAYER;

The Authorized Version.

With ten engravings, executed in the best manner, on steel.—In embossed binding, 4s., uniform with the Cabinet Bible.

Jones's Animal Kingdom.

A GENERAL OUTLINE OF THE ANIMAL KINGDOM AND MANUAL OF COMPARATIVE ANATOMY.

By T. RYMER JONES, F.Z.S., Professor of Comparative Anatomy in King's College, London; Fullerian Professor of Physiology in the Royal Institution of Great Britain; Examiner in Comparative Anatomy to the University of London.—In one thick vol. 8vo., containing nearly 350 illustrations, 38s. Royal 8vo., 3l. 16s. or Imperial 8vo., 5l. 14s.*

Bell's British Quadrupeds.

A HISTORY OF BRITISH QUADRUPEDS,

INCLUDING THE CETACEA.

By THOMAS BELL, F.R.S., F.L.S., V.P.Z.S., ETC. Professor of Zoology in King's College, London.

Nearly 200 illustrations, 8vo., 28s. A few copies are also printed in royal 8vo., price 2l. 16s., and a very limited number in imperial 8vo., price 4l. 4s.*

Yarrell's British Birds.

A HISTORY OF BRITISH BIRDS.

By WILLIAM YARRELL, F.L.S., V.P.Z.S., ETC.

This work contains a history and a picture portrait, engraved expressly for this work, of each species of the Birds found in Britain. The three volumes contain 520 illustrations. Price in demy 8vo. 4l. 10s.; royal 8vo. 9l.; or imperial 8vo. 13l. 10s. To suit the convenience of purchasers, the work will still be sold in volumes. Vol. I. price 28s.; Vol. II. 35s.; Vol. III. 30s.*

Bell's British Reptiles.

A HISTORY OF BRITISH REPTILES.

By THOMAS BELL, F.R.S., F.L.S., V.P.Z.S., ETC. Professor of Zoology in King's College, London.

8vo. with more than 40 illustrations, price 8s. 6d. Royal 8vo. 17s. or Imperial 8vo., 25s. 6d.*

JOHN VAN VOORST, 1, PATERNOSTER ROW.

Yarrell's British Fishes.

A HISTORY OF BRITISH FISHES.

By WILLIAM YARRELL, F.L.S., V.P.Z.S., ETC.

Second Edition, in two vols. demy 8vo., illustrated by nearly 500 engravings, price Three Pounds. A Supplement to the first edition, demy 8vo., 7s. 6d. Royal 8vo., 15s., or Imperial 8vo., 1l. 2s. 6d.*

Forbes's British Starfishes.

A HISTORY OF BRITISH STARFISHES, AND OTHER ANIMALS OF THE CLASS ECHINODERMATA.

By EDWARD FORBES, M.W.S., Professor of Botany in King's College, London. 8vo., with more than 120 Illustrations, 15s., or Royal 8vo., 30s.*

Selby's British Forest-trees.

A HISTORY OF BRITISH FOREST-TREES, INDIGENOUS AND INTRODUCED.

By PRIDEAUX JOHN SELBY, F.L.S., M.W.S., ETC.—Nearly 200 Engravings. 8vo. 28s. Royal 8vo. 2l. 16s.*

Doubleday's List of Birds.

A NOMENCLATURE OF BRITISH BIRDS.

FOR LABELING COLLECTIONS OF BRITISH BIRDS AND THEIR EGGS.

By HENRY DOUBLEDAY.—Third edition, 1s. 6d. sewed.

Bonaparte's List of Birds.

A GEOGRAPHICAL AND COMPARATIVE LIST OF THE BIRDS OF EUROPE AND NORTH AMERICA.

By CHARLES LUCIEN BONAPARTE, Prince of Canino.—8vo. 5s.

Yarrell on the Salmon.

A PAPER ON THE GROWTH OF THE SALMON IN FRESH WATER.

By MR. YARRELL.

With six illustrations of the fish of the natural size, exhibiting its structure and exact appearance at various stages during the first two years. 12s. sewed.

Jesse's Angler's Rambles.

AN ANGLER'S RAMBLES.

By EDWARD JESSE, F.L.S., Author of "Gleanings in Natural History."

Contents:—Thames Fishing.—Trolling in Staffordshire.—Perch Fishing-club.—Two Days' Fly-fishing on the Test.—Luckford Fishing-club.—Grayling Fishing.—A Visit to Oxford.—The Country Clergyman. Post 8vo., price 10s. 6d.

JOHN VAN VOORST, 1, PATERNOSTER ROW.

Boccius on Fish and Fish Ponds.

A TREATISE ON

THE MANAGEMENT OF FRESH-WATER FISH,

WITH A VIEW TO MAKING THEM A SOURCE OF PROFIT TO LANDED PROPRIETORS.

By GOTTLIEB BOCCIUS.—8vo. price 5s.

Bathurst's Notes on Nets.

NOTES ON NETS;

OR, THE QUINCUNX PRACTICALLY CONSIDERED.

To which are added miscellaneous memoranda. By the Hon. and Rev. CHARLES BATHURST, LL.D. late Fellow of All-Souls College, Oxford. 12mo. 4s.

Moule's Heraldry of Fish.

HERALDRY OF FISH.

By THOMAS MOULE.—8vo., price 21s.; a few on large paper, (royal 8vo.,) for colouring, price 2l. 2s.

Nearly six hundred families are noticed in this work, and besides the several descriptions of fish, fishing-nets, and boats, are included also mermaids, tritons, and shell-fish. Nearly seventy ancient seals are described, and upwards of twenty subjects in stained glass. The engravings, two hundred and five in number, are from stained glass, tombs, sculpture and carving, medals and coins, rolls of arms, and pedigrees.*

Newman's System of Nature.

THE SYSTEM OF NATURE:

AN ESSAY.

By EDWARD NEWMAN, F.L.S., F.Z.S., ETC. Second edition. 8vo. 10s.

Jenyns's White's Selborne.

THE NATURAL HISTORY OF SELBORNE.

By THE LATE REV. GILBERT WHITE, M.A.

A new edition, with notes by the REV. LEONARD JENYNS, M.A., F.L.S., ETC.; with 26 illustrations, foolscap 8vo. 7s. 6d.*

Gosse's Canadian Naturalist.

THE CANADIAN NATURALIST.

By PHILIP HENRY GOSSE, Cor. Mem. of the Nat. Hist. Soc. of Montreal, and of the Lit. and Hist. Soc. of Quebec.

Forty-four illustrations of the most remarkable Animal and Vegetable productions. Post 8vo., 12s.*

Dunn's Guide to Orkney and Shetland.

THE ORNITHOLOGIST'S GUIDE TO THE ISLANDS OF ORKNEY AND SHETLAND.

By ROBERT DUNN.—Post 8vo. 5s.

JOHN VAN VOORST, 1, PATERNOSTER ROW.

Bevan on the Honey Bee.

THE HONEY BEE;

ITS NATURAL HISTORY, PHYSIOLOGY, AND MANAGEMENT.

By EDWARD BEVAN, M.D.

A new edition, 12mo., with many illustrations, 10s. 6d.

Beale on the Sperm Whale.

THE NATURAL HISTORY OF THE SPERM WHALE,

AND A SKETCH OF A SOUTH SEA WHALING VOYAGE.

By THOMAS BEALE, late Surgeon to the "Kent," and "Sarah and Elizabeth,"
South Seamen. Post 8vo., 12s.

Newman's Grammar of Entomology.

A FAMILIAR INTRODUCTION TO THE HISTORY OF INSECTS.

By EDWARD NEWMAN, F.L.S., ETC.—With numerous Illustrations.

One vol. 8vo., 12s. *

Morris's British Fossils.

A CATALOGUE OF BRITISH FOSSILS.

Comprising all the genera and species hitherto described; with references to their geological distribution and to the localities in which they have been found.

By JOHN MORRIS. 8vo. 10s.

Babington's Manual of British Botany.

A MANUAL OF BRITISH BOTANY;

Containing the Flowering Plants and Ferns, arranged according to the natural orders, by CHARLES C. BABINGTON, M.A., F.L.S., F.G.S., &c. 12mo. 9s.

Harvey's British Algae.

A MANUAL OF BRITISH ALGÆ.

By the Hon. W. H. HARVEY. Containing generic and specific descriptions of all the known British species of Sea-weed, and of *Confervæ*, both marine and freshwater.—8vo. 9s.

Couch's Fauna of Cornwall.

A CORNISH FAUNA;

Being a compendium of the Natural History of the County. By JONATHAN COUCH, F.L.S., ETC. 8vo. Parts 1 and 2, each 2s.

Leighton's Flora of Shropshire.

A FLORA OF SHROPSHIRE.

By W. A. LEIGHTON, B.A., F.R.S.E., ETC.—Comprising the flowering Plants indigenous to the County, arranged on the Linnæan system. 8vo. 24s.

Ward on Plant Cases.

ON THE GROWTH OF PLANTS IN CLOSELY-GLAZED CASES.

By N. B. WARD, F.L.S.—8vo., 5s.

JOHN VAN VOORST, 1, PATERNOSTER ROW.

Luxford's Flora of Reigate.

A FLORA OF THE NEIGHBOURHOOD OF REIGATE, SURREY;

CONTAINING THE FLOWERING PLANTS AND FERNS.

By GEORGE LUXFORD, A.L.S., F.R.S.E.—12mo. with a map of the district, 5s.

Owen on the *Mylodon*.

DESCRIPTION OF THE SKELETON OF AN EXTINCT
GIGANTIC SLOTH.

With Observations on the Osteology, Natural Affinities, and probable habits of the Megatherioid Quadrupeds in general. By RICHARD OWEN, F.R.S., ETC.
4to. 1l. 12s. 6d.

Bowerbank's Fossil Fruits and Seeds.

A HISTORY OF THE FOSSIL FRUITS AND SEEDS OF THE
LONDON CLAY.

By JAMES SCOTT BOWERBANK, F.G.S., ETC.

The first Part, in Royal 8vo. price 16s., contains the description, and 423 figures engraved on 17 copper plates by MR. JAMES DE CARL SOWERBY.

Bartlett's Index Geologicus.

INDEX GEOLOGICUS.

A diagram 3 ft. 6 in. by 2 ft. 9 in.; showing the position and age of every deposit, and their "localities;" the classification of their Fossils, Metals, and Minerals; the statistics of Soils and indigenous Flora of each surface in Britain, &c.

By G. BARTLETT.—On roller, or in case 25s.

Microscopical Transactions.

TRANSACTIONS OF THE MICROSCOPICAL SOCIETY
OF LONDON.

Part I. Royal 8vo., with eight plates. 7s. 6d.

Aikin's Arts and Manufactures.

ILLUSTRATIONS OF ARTS AND MANUFACTURES;

being a Series of Papers on Pottery, Limestone, and Calcareous Cements, Gypsum and its uses, Furs and the Fur Trade, Felting and Hat-making, Bone and its uses, Tortoiseshell and Whalebone, Antiquarian and Metallurgical History of Iron, Engraving and Etching, and on Paper. Read before the Society for the Encouragement of Arts, Manufactures, &c.

By ARTHUR AIKIN, F.L.S., F.G.S., ETC. late Secretary to that Institution.
In foolscap 8vo., Illustrated. Price 8s. cloth.*

The Virgin Islands.

LETTERS FROM THE VIRGIN ISLES.

Illustrating Life and Manners in the West Indies. In post 8vo. 9s. 6d.

JOHN VAN VOORST, 1, PATERNOSTER ROW.

Bullars' Azores and Furnas Baths.

A WINTER IN THE AZORES,
AND A SUMMER AT THE BATHS OF THE FURNAS.

By JOSEPH BULLAR, M.D., and HENRY BULLAR, of Lincoln's Inn.

Two vols. 8vo., with Illustrations, 28s. *

Clive's History of Ludlow.

DOCUMENTS CONNECTED WITH
THE HISTORY OF LUDLOW AND THE LORDS MARCHERS.

Edited by the Hon. ROBERT H. CLIVE.—Imperial 8vo., 31s. 6d.

Elements of Knowledge.

ELEMENTS OF PRACTICAL KNOWLEDGE;

OR, THE YOUNG INQUIRER ANSWERED.

Explaining, in question and answer, and in familiar language, what most things daily used, seen, or talked of, are; what they are made of, where found, and to what uses applied. Second Edition, 18mo., with Illustrations, 3s.

Little Fables:

LITTLE FABLES FOR LITTLE FOLKS.

Selected for their moral tendency, and re-written in familiar words, not one of which exceeds two syllables. 18mo. 1s. 6d.

Harding's Stenography.

UNIVERSAL STENOGRAPHY;

OR, A NEW AND PRACTICAL SYSTEM OF SHORT HAND WRITING,
On the basis of Taylor. By WILLIAM HARDING. 12mo. 3s. swd, 3s. 6d. bound.

Wilson's Christ's Hospital.

A BRIEF HISTORY OF CHRIST'S HOSPITAL,

FROM ITS FOUNDATION BY KING EDWARD THE SIXTH.

By J. I. WILSON.

Seventh Edition, with Six Illustrations, and a List of the Governors.—Small 8vo., 4s.

Dodsley's Economy of Human Life.

A CABINET EDITION OF
THE ECONOMY OF HUMAN LIFE.

IN TWELVE BOOKS.

By R. DODSLEY.—With twelve plates, engraved on steel, from original designs,
by Frank Howard, Harvey, Williams, &c. 18mo., gilt edges, 5s.

Poems and Hymns.

ORIGINAL AND SELECT POEMS AND HYMNS.

A COMPANION TO SACRED POETRY.

32mo. half-bound, 2s. 6d.

JOHN VAN VOORST, 1, PATERNOSTER ROW.

Works now in course of Publication.

- PROFESSOR ANSTED'S GEOLOGY.—INTRODUCTORY, DESCRIPTIVE, AND PRACTICAL. In 8 monthly parts, 5s. each.
- PROFESSOR OWEN'S HISTORY OF BRITISH FOSSIL MAMMALIA.* In about 8 monthly half-crown parts.
- MR. NEWMAN'S HISTORY OF BRITISH FERNS. New edition. In three parts, 8s. each.
- ILLUSTRATIONS OF BAPTISMAL FONTS, with Descriptions, in half-crown monthly parts, each containing 16 Engravings.*
- A HISTORY OF THE FISHES OF MADEIRA. By RICHARD THOMAS LOWE, M.A., British Chaplain. With original figures from nature of all the species, by the Hon. C. E. C. NORTON and M. YOUNG. Price of each part, in 8vo. 2s. 6d. plain, 5s. coloured; or in 4to. 5s. plain, 7s. 6d. coloured.
- HEWITSON'S BRITISH BIRDS' EGGS. Coloured illustrations of the Eggs of British Birds, accompanied with Descriptions of the Eggs, Nests, &c. By WILLIAM C. HEWITSON.—Will be completed in 32 monthly half-crown parts.
- THE ZOOLOGIST, a Journal of Natural History. 1s. monthly.
- THE PHYTOLOGIST, a Botanical Journal. 1s. monthly.
- THE LONDON PHYSIOLOGICAL JOURNAL, in continuation of the Microscopic Journal. Edited by Dr. GOODFELLOW and ED. QUECKETT. 1s. monthly.
-

In Preparation.

- MR. GARNER'S NATURAL HISTORY OF THE COUNTY OF STAFFORD. In a few days.
- MESSRS. TULK AND HENFREY'S ANATOMICAL MANIPULATION. In a few days.
- PROFESSOR RYMER JONES'S LECTURES ON NATURAL HISTORY.
- REV. LEONARD JENYNS' OBSERVATIONS AND NOTES ON VARIOUS BRANCHES OF NATURAL HISTORY.
- PROFESSOR BELL'S HISTORY OF BRITISH CRUSTACEA.
- MR. HERBERT'S TRANSLATION OF GROTIUS' INTRODUCTION TO DUTCH JURISPRUDENCE.
- PROFESSOR EDWARD FORBES' RAMBLES OF A NATURALIST.
- REV. EDWARD MILLER'S VOLUME OF SERMONS, PREACHED AT BOGNOR.
- THE FARMER'S BOY, and other RURAL TALES, by BLOOMFIELD. With Illustrations by SIDNEY COOPER, HORSLEY, FREDERICK TAYLER, and WEBSTER.
- MR. BULLAR'S (of Southampton) LAY LECTURES.
-

AN ILLUSTRATED CATALOGUE

of the Works published by JOHN VAN VOORST, Paternoster Row, London, first door on the right coming from Cheapside. 8vo. price 1s. This Catalogue contains a specimen of the illustrations contained in the 16 works thus (*) marked.

JOHN VAN VOORST, 1, PATERNOSTER ROW.



Work
over

